

CombiSteel

2023



Stef van Bakel

koeltechniek

Alkmaar ☎ 072 564 7000

Dealer catalog

Dealer catalogus
Händlerkatalog
Catalogue général

+400
NEW
ITEMS!



Uw partner in Horeca- en catering apparatuur

Met meer dan 20 jaar ervaring begrijpen wij wat er nodig is om op de steeds hogere standaard en eisen van de klant in te spelen. In een markt die voortdurend in beweging is en dus een flexibele aanpak vereist, onderscheidt Combisteel zich door een brede know-how en een persoonlijke benadering van elke klant. Wij richten ons op concurrerende prijzen, snelle levertijden, hoge kwaliteit en goede after-sale service.

Met een zeer breed assortiment dat meer dan 3000 producten omvat, hebben wij vrijwel elke sector iets te bieden. Van restaurants, eetcafés, pizzeria's, sportkantines tot bedrijfsrestaurants en meer. Mocht u vragen hebben dan kunt u altijd contact opnemen met ons team dat u graag verder helpt.



Ihr Partner für Hotel und Gaststättengewerbe und Catering Geräte

Mit über 20 jähriger Erfahrung im Bereich wissen wir genau wie wir den immer höheren Standards und Anforderungen der Kunden am Besten entsprechen können. In einem Markt der ständig in Bewegung ist und deswegen flexible Verfahren erfordert, hat Combisteel sich das Ziel gesetzt, sich zu unterscheiden durch breites Know-how und eine persönliche Vorgehensweise der Kunden. Außerdem unterscheiden wir uns durch die Wichtigkeit der Wettbewerbspreise, schneller Lieferzeiten, hohe Qualität und eines guten After Sales Service.

Dank einem breiten Angebot von über 3000 Produkten, können wir fast in jedem Bereich unsere Dienste leisten. Denken Sie z.B. an: Restaurants, Gaststätten, Pizzerien, Sportkantinen, Betriebsrestaurants, usw. Unser Team steht Ihnen für Fragen, deren Antwort Sie nicht in unserem Katalog finden, gerne zur Verfügung.



Your partner in food service and catering equipment

With more than 20 years experience in the industry we understand what it takes to strive for a higher standard of service to our customers. In our changing market we need to be flexible at all times. Combisteel distinguishes itself by having a broad knowledge base and a personal approach for each customer. We aim for competitive pricing, fast delivery, high quality, and good after-sale service.

Our product range of over 3000 products allows us to serve all sectors from restaurants, snack bars, pizzerias, canteens, to company restaurants and more. Our team is always ready to answer any question that you may have so please don't hesitate to get in touch.



Votre partenaire en équipement de restauration et de traiteur

Avec plus de 20 ans d'expérience, nous sommes à même de comprendre ce qui est nécessaire pour répondre à un niveau de qualité toujours croissant et aux exigences de la clientèle. Dans un marché continuellement en mouvement, il est souhaitable de faire preuve de flexibilité, Combisteel veut s'y distinguer par son savoir-faire étendu et son approche personnelle de chaque client. Naturellement, nous ne devons jamais perdre de vue que des prix concurrentiels, des délais de livraison rapides, une bonne qualité et un bon service après-ventes sont tout aussi primordiaux.

Avec un très large assortiment, comprenant plus de 3000 produits, nous pouvons contribuer pratiquement dans chaque secteur à une plus-value certaine qui peut s'appliquer par exemple aux: restaurants, snack-bars, pizzerias, cantines de clubs sportifs, restaurants d'entreprises, et plus. Notre équipe se tient toujours à votre disposition pour répondre aux des questions!

	Aantal bladen Anzahl de Blätter Number of sheets Nombre de feuilles
	Aantal blikjes Anzahl Dosen Number of cans Nombre de Canettes
	Aantal flessen Anzahl Flaschen Number of bottles Nombre de Bouteilles
	Aantal glazen per uur Anzahl Gläser per Stunde Number of glasses per hour Nombre de verres par heure
	Aantal pizza's Anzahl Pizzen Number of pizzas Nombre de pizzas
	Afmeting snijoppervlakte Größe Schnittfläche Dimensions working table Dimension de la zone de découpage
	Afmetingen Uitblaas Abmessungen Abluft Exhaust dimensions Dimensions sortie du flux
	Ampere Ampere Ampere Ampère
	Automatische ontdooing Automatische Abtaufunktion Automatic defrost Dégivrage automatique
	Capaciteit Gram Belastbarkeit in g Capacity gram Capacité en gram
	Capaciteit KG/24 Traglast 24 kg Capacity KG/24 Capacité KG/24
	Capaciteit M³ Volumen m³ Capacity M³ Capacité M³
	Chroom Verchromt Chrome Chrome
	Clip voor rooster Clip für Roste Clip for grid Clip pour grille
	Cyclusduur Dauer Zyklus Duration cycle Durée du cycle
	Demontabel Selbstmontage Flat-packed Démontable
	Deur breedte Breite Tür Width door Largeur de la porte
	Deur slot Türschloss Door lock Serrure
	Dikte Materialstärke Thickness Épaisseur
	Doorsnede Durchmesser Diameter Diamètre
	Doorsnede pizza's Durchmesser Pizzen Diameter pizza Diamètre pizza
	Doorsnede snijblad Klinge Durchmesser Diameter blade Diamètre de la lame
	Draairichting deur instelbaar Türanschlag wechselbar Adjustable door rotation Porte interchangeable
	Drainage Ablauf Drainage Drainage
	Droogtijd Trockenzeit Dry time Temps de séchage
	Energie label beschikbaar Energie label verfügbar Energy label available Label énergétique disponible

	Euronorm (EN) Euronorm (EN) Euronorm (EN) Euronorm (EN)
	Externe afmetingen (l x d x h) External dimensions (l x d x h) Dimensions extérieures (l x d x h) Abmessungen extern (l x d x h)
	Gas Gas Gas Gaz
	Geleiderset Set Einschubleisten Set Guides Série de conducteur
	Geribbled Gerillt Grooved Rainurées
	Geschikt voor in de vaatwasser Suitable for in the dishwasher Support for saladette Convient au lave-vaisselle
	Geventileerd Umluft Ventilated Ventilé
	Gewicht Gewicht Weight Poids
	Glad Glatt Smooth Lisse
	GN Maat GN Größe GN Size GN taille
	Graden Celcius Grad Celcius Degrees Celsius Degrés Celcius
	Grill oppervlakte Grillfläche Grill surface Surface Grill
	Handgreep Griff Handles Manipuler
	Handmatige ontdooing Manuelle Abtaufunktion Manual defrost Dégivrage manuel
	Ijsbak Eis Eimer Ice bucket Seau à glace
	Inhoud liter Inhalt in Liter Content litres Contenu en litres
	Interne afmetingen (l x d x h) Abmessungen intern (l x d x h) Internal dimensions (l x d x h) Dimensions intérieures (l x d x h)
	Isolatie mm Isolationsstärke in mm Isolation en mm Insulation mm
	Kip Hähnchen Chicken Poulet
	Kg per uur Kg per Stunde Kg per hour Kg par heure
	Korven bestek Besteckkorb Basket cutlery Panier a couverts
	Korven borden Tellerkorb Basket dishes Panier a assiettes
	Korven glas Gläserkorb Basket glass Panier a verres
	Korven per uur Körbe per Stunde Racks per hour Paniers par heure
	Koudemiddel Kältemittel Refrigerant Gaz réfrigérant
	Kraan aansluiting Wasserzulauf Faucet connection Connection robiner

	Laadhoogte Einschubhöhe Loading height Hauteur de chargement
	Ladenset Schubladensatz Drawerset Bloc de tiroirs
	Lengte lint Band Länge Band length Longeur du ruban
	Mand tbv vrieskist Körbe für Tiefkühltruhe Basket for chest freezer Panier pour congélateur bahut
	Menghoeveelheid Mischmenge Mixing amount Quantité de mélange
	Niveaus Ebenen Levels Ebenen
	Pakketpost Paketpost Parcel ready Colis postal
	Potenset Pftenserie Support set Série de pieds
	Robbreedte Rollenbreite Roll width Largeur du rouleau
	Roosters Einlegeroste Grids Grille
	Rpm U/min Rpm Nombre de Tours/Min
	Set kratten Lattenkiste Setzen Set of baskets Série de paniers
	Snelheden Geschwindigkeiten Speeds Geschwindigkeiten
	Snijdikte Schnittstärke Slice thickness Épaisseur de la tranche
	Snij capaciteit Schnittkapazität Cutting capacity Capacité de coupe
	Standregelaar Geschwindigkeitsregle Speed controller Régulateur de vitesse
	Spies Spieß Skewer Brochette
	Statisch Statisch Static Statique
	Trolley Wagen Trolley Chariot
	Uitlaat Auspuff Exhaust Échappement
	Verlichting Beleuchtung Lighting Éclairage
	Volt/kW Volt/kW Volt/kW Volt/kW
	Voorraad Stock Stock Lagerbestand
	Wasbak Washbecken Sink Évier
	Werktafel Basteltisch Worktable Table de fabrication
	Wielenset Rädersatz Castors set Série de roues





Koeling
Kühlung
Refrigeration
Réfrigération



Refrigeration

Refrigerators & Freezer Cabinets

Refrigerated & Freezer Counters

Saladettes

Coldrooms

Chest Freezers

Display/Refrigeration

Ice Machines



ENERGIELABEL

Sinds 1 juli 2016 is het energielabel verplicht voor koel- en diepvriesapparaten op de professionele markt. Dit houdt in dat er alleen nog apparaten verkocht worden die weinig energie verbruiken en de apparaten moeten voortaan voorzien worden van een energielabel met informatie over het energieverbruik. Het energielabel wordt in de basis ingevoerd voor (snel)koel- en vriezers met een bewaarfunctie voor levensmiddelen.

Dit betekent dat voor apparaten met een display- of toonfunctie, zoals glasdeurkasten, vitrines, diepvrieskasten en saladettes, een energielabel niet verplicht is. De regeling geldt ook alleen voor apparaten met een geforceerde of geventileerde koeling. Dat houdt in dat statische apparaten, die geen gebruik maken van een ondersteunende ventilator, ook buiten de regeling vallen. Voor meer informatie over het energielabel verwijzen wij u graag door naar onze website.

ENERGIELABEL

Ab 1. Juli 2016 ist das Energielabel für Kühl- und Tiefkühlgeräte auf dem gewerblichen Markt verbindlich. Kurz zusammengefasst dürfen nur noch Geräte verkauft werden, die wenig Energie verbrauchen, und die Geräte müssen ab diese Datum mit einem Energielabel versehen werden das über den Energieverbrauch informiert. Das Energielabel wird generell für (Schnell-)Kühl- und Tiefkühlgeräte eingeführt, in denen Lebensmittel gelagert werden. Das bedeutet, dass das Energielabel für Geräte mit einer Display- oder Showfunktion wie Glastürschränke, Vitrinen, Tiefkühltruhen und Salatbars nicht obligatorisch ist. Die Regelung gilt auch nur für Geräte mit ventilierter- oder Umluftkühlung. Daraus folgt, dass vollkommen statische Geräte, die keinen unterstützenden Ventilator benutzen, auch nicht von der Regelung betroffen sind. Weitere Informationen über die Energie, die wir verweisen Sie auf unsere Website.

ENERGY LABEL

On the 1st of July, 2016 the energy label became obligatory for refrigeration and freezer equipment on the professional market. To summarise it briefly, only appliances with a low energy consumption can be sold, and they will have to be provided with an energy label containing information about their energy consumption. Initially the energy label will be introduced for (blast) refrigerators and freezers with a storage function for food products. This means that the energy label is not obligatory for appliances with a display function, like glass door refrigerators, showcases, chest freezers, and saladettes. Also, the regulation only applies to appliances with a forced or ventilated cooling system. This means that appliances that are purely static and do not use a supporting ventilator are also exempt from the regulation. For more information about the energy label we would like to refer you to our website.

ÉTIQUETTE ÉNERGÉTIQUE

Elle est obligatoire pour tous les appareils de réfrigération et de congélation sur le marché professionnel. En résumé, il n'est vendu uniquement les appareils qui utilisent peu d'énergie et qui sont dotés d'une étiquette comprenant les informations sur la consommation d'énergie. L'étiquette énergétique est introduite à la base pour les réfrigérateurs et congélateurs ayant une fonction de conservation des denrées alimentaires. Cela veut dire que pour les appareils qui sont utilisés pour présentation ou exposition, comme les frigos avec une porte en verre, les vitrines, les congélateurs bahut et les saladettes, une étiquette énergétiques n'est pas obligatoire. La réglementation s'applique aussi exclusivement pour les appareils avec une réfrigération forcée ou ventilée. Cela signifie que les appareils simplement statiques, qui n'utilisent pas de ventilateur de soutien, tombent également en dehors de la réglementation. Pour plus d'informations sur l'énergie que nous vous invitons à consulter notre site Web.



REFRIGERATOR GLASS DOOR

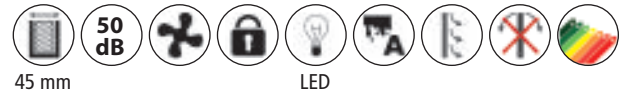

	7450.0552	7450.0557	7450.0562
	€ 680,-	€ 1.060,-	€ 1.325,-
	600 x 585 x 855	600 x 585 x 1855	777 x 695 x 1895
	510 x 485 x 620	510 x 485 x 1620	657 x 580 x 1660
	230 V / 0,15 kW	230 V / 0,185 kW	230 V / 0,185 kW
	130 L	350 L	570 L
	+2/+8°C	+2/+8°C	+2/+8°C
	R 600 A	R 600 A	R 600 A
GN	X	X	4x 2/1
	3x	4x	4x
	49	74	97

KOELKAST GLASDEUR

- LED verlichting
- Statische koeler met hulp ventilator
- Verstelbare roosters
- Behuizing wit gepoedercoat
- Manuele thermostaat
- Digitale display
- Voorzien van slot

KÜHLSCHRANK GLASTÜR

- LED Beleuchtung
- Statische Kühlung mit Ventilator
- Einstellbare Gitter austauschbar
- Gehäuse weiß pulverbeschichtet
- Manuelles Thermostat
- Digitalanzeige
- Abschließbar

REFRIGERATOR GLASS DOOR

- LED Lighting
- Static cooler, fan assisted
- Adjustable shelves
- White powdercoated
- Manual thermostat
- Digital display
- Lock

RÉFRIGÉRATEUR PORTE EN VERRE

- Éclairage LED
- Froid statique, assisté par ventilateur
- Grilles Ajustables
- Laqué blanc
- Thermostat manuel
- Affichage numérique
- Fermeture à clé

7451.0015		€ 20,-
	Grids	
>	7450.0552 - 0557	
	502 x 440	

7451.0016		€ 21,-
	Grids	
>	7450.0561 - 0560	
	650 x 535	
GN	2/1GN	

7451.0045		€ 80,-
	Support set (4x)	



Refrigeration

REFRIGERATOR



	7450.0551	7450.0556	7450.0561	7450.0550	7450.0555	7450.0560
	€ 586,-	€ 975,-	€ 1.160,-	€ 699,-	€ 1.092,-	€ 1.355,-
	WHITE	WHITE	WHITE	STAINLESS STEEL	STAINLESS STEEL	STAINLESS STEEL
	600 x 585 x 850	600 x 585 x 1850	775 x 695 x 1885	600 x 585 x 850	600 x 585 x 1850	775 x 695 x 1885
	510 x 485 x 620	510 x 485 x 1620	665 x 580 x 1660	510 x 485 x 620	510 x 485 x 1620	665 x 580 x 1660
	230 V / 0,15 kW	230 V / 0,185 kW	230 V / 0,2 kW	230 V / 0,15 kW	230 V / 0,185 kW	230 V / 0,2 kW
	130 L	350 L	570 L	130 L	350 L	570 L
	0/+8°C	0/+8°C	0/+8°C	0/+8°C	0/+8°C	0/+8°C
	R 600 A	R 600 A	R 600 A	R 600 A	R 600 A	R 600 A
GN	X	X	4x 2/1GN	X	X	4x 2/1GN
	3x	4x	X	3x	4x	X
	44	69	90	44	69	90

🇳🇱 KOELKAST

- Draairichting deur verwisselbaar
- Statische koeler met hulp ventilator
- Verstelbare roosters
- 7450.0551-0556-0561: Behuizing wit gepoedercoat
- 7450.0550-0555-0560: Behuizing RVS
- Manuele thermostaat
- Digitale display
- Voorzien van slot

🇩🇪 KÜHLSCHRANK

- Türdrehrichtung austauschbar
- Statische Kühlung mit Ventilator
- Einstellbare Gitter austauschbar
- 7450.0551-0556-0561: Gehäuse weiß pulverbeschichtet
- 7450.0550-0555-0560: Gehäuse Edelstahl
- Manuelles Thermostat
- Digitalanzeige
- Abschließbar

🇬🇧 REFRIGERATOR

- Reversible solid door
- Static cooler, fan assisted
- Adjustable shelves
- 7450.0551-0556-0561: White powdercoated
- 7450.0550-0555-0560: Outside stainless steel
- Manual thermostat
- Digital display
- Lock

🇫🇷 RÉFRIGÉRATEUR

- Porte pleine réversible
- Froid statique, assisté par ventilateur
- Tablettes réglables
- 7450.0551-0556-0561: Laqué blanc
- 7450.0550-0555-0560: Extérieur INOX
- Thermostat manuel
- Affichage numérique
- Fermeture à clé

7451.0016 € 21,-

	Grids
	> 7450.0561-0560
	650 x 535
GN	2/1GN

7451.0015 € 20,-

	Grids
	> 7450.0551-0556 7450.0550-0555
	502 x 440

7451.0011 € 100,-

	Castors set
--	-------------

7451.0045 € 80,-

	Support set (4x)
--	------------------



FREEZER



Cooking range

Drop-in

Ovens

Kitchen equipment

Refrigeration

Dishwashers

Neutral

Faucets

Ventilation

Pizzeria

Bakery

	7450.0566	7450.0571	7450.0576	7450.0565	7450.0570	7450.0575
	€ 655,-	€ 1.080,-	€ 1.290,-	€ 750,-	€ 1.198,-	€ 1.480,-
	WHITE	WHITE	WHITE	STAINLESS STEEL	STAINLESS STEEL	STAINLESS STEEL
	600 x 585 x 850	600 x 585 x 1850	775 x 695 x 1885	600 x 585 x 850	600 x 585 x 1850	775 x 695 x 1885
	510 x 485 x 620	510 x 485 x 1620	665 x 580 x 1660	510 x 485 x 620	510 x 485 x 1620	665 x 580 x 1660
	230 V / 0,15 kW	230 V / 0,21 kW	230 V / 0,35 kW	230 V / 0,15 kW	230 V / 0,21 kW	230 V / 0,35 kW
	120 L	340 L	555 L	120 L	340 L	555 L
	<-18/-22°C	<-18/-22°C	<-18/-22°C	<-18/-22°C	<-18/-22°C	<-18/-22°C
	R 600 A	R 600 A	R 600 A	R 600 A	R 600 A	R 600 A
	2x	6x	6x	2x	6x	6x
	44	74	94	44	74	94

VRIESKAST

- Draairichting deur verwisselbaar
- Statische vriezer
- Vaste roosters
- 7450.0566-0571-0576: Behuizing wit gepoedercoat
- 7450.0565-0570-0575: Behuizing RVS
- Manuele thermostaat
- Digitale display
- Voorzien van slot

TIEFKÜHLSCHRANK

- Türdrehrichtung austauschbar
- Statische Tiefkühlschrank
- Feste Gitter
- 7450.0566-0571-0576: Gehäuse weiß pulverbeschichtet
- 7450.0565-0570-0575: Gehäuse Edelstahl
- Manuelle Thermostat
- Digitalanzeige
- Abschließbar

FREEZER

- Reversible solid door
- Static freezer
- Fixed shelves
- 7450.0566-0571-0576: White powder coated
- 7450.0565-0570-0575: Outside stainless steel
- Manual thermostat
- Digital display
- Lock

CONGÉLATEUR

- Porte pleine réversible
- Congélateur statique
- Étagères fixes
- 7450.0566-0571-0576: Laqué blanc
- 7450.0565-0570-0575: Extérieur en acier inoxydable
- Thermostat manuel
- Affichage numérique
- Fermeture à clé

7451.0021 € 203,-

Set of baskets

> 7450.0576 - 0575

7451.0011 € 100,-

Castors set

7451.0045 € 80,-

Support set (4x)



Refrigeration

STANDARD LINE

REFRIGERATOR/FREEZER



60 mm

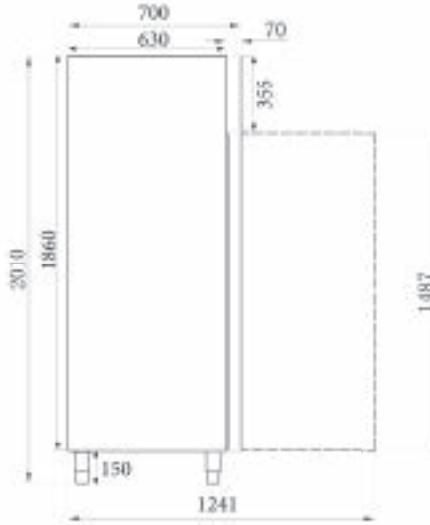

7450.0700

€ 1.870,-



REFRIGERATOR

7450.0702

€ 2.250,-



FREEZER

	REFRIGERATOR	FREEZER
	484 x 700 x 2010	484 x 700 x 2010
	368 x 580 x 1396	368 x 580 x 1396
	230 V / 0,25 kW	230 V / 0,65 kW
	350 L	350 L
	-2/+8°C	-18/-25°C
	R 600 A	R 290
	110	110

KOELKAST / VRIESKAST

- Isolatie 60mm
- Omgevingstemp. +32°C
- Vast ingebouwde compressor
- Incl. 3 roosters 1/1GN en geleiderset
- Cap. 21 geleiders
- Ruimte tussen geleiders 55mm

KÜHLSCHRANK / TIEFKÜHLSCHRANK

- Isolierschicht 60mm
- Umgebungstemp. +32°C
- Fest installierte Kompressor
- Einschließlich 3 Gitter 1/1GN mit Führungsschiene
- Für maximal 21 Führungsschienen
- Abstand zwischen Führungsschienen 55mm

REFRIGERATOR / FREEZER

- Insulation 60mm
- Ambient temp. +32°C
- Permanently installed compressor
- Incl. 3 grids 1/1GN and set guides
- Cap. 21 guides
- Space between guides 55mm

RÉFRIGÉRATEUR / CONGÉLATEUR

- Isolation 60mm
- Temp. ambiente +32°C
- Compresseur fixé
- 3 Grilles 1/1GN et Glissières inclus
- Cap. 21 Glissières
- Espace entre les Glissières 55mm

7450.0505 € 27,-

	Grids PE coated
GN	1/1GN

7451.0010 € 83,-

	Castors set
--	-------------

7450.0500 € 35,-

	Set guides
--	------------



REFRIGERATOR/FREEZER

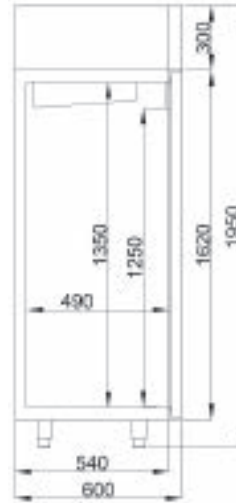

Cooking range

Drop-in

Ovens

Kitchen equipment

7489.5060	7489.5070	7489.5065
€ 2.005,-	€ 2.225,-	€ 2.245,-

Refrigeration

	REFRIGERATOR	REFRIGERATOR FOR FISH	FREEZER
	600 x 600 x 1950	600 x 600 x 1950	600 x 600 x 1950
	230 V / 0,13 kW	230 V / 0,13 kW	230 V / 0,40 kW
	400 L	400 L	400 L
	-2/+8°C	0/-5°C	-10/-18°C
	R 290	R 290	R 290
	X	✓	X
	✓	X	✓
	100	100	105

Dishwashers

Neutral

Faucets

KOELKAST / VRIESKAST

- Isolatie 50mm
- Omgevingstemp. +32°C
- Vast ingebouwde compressor
- Incl. 3 roosters en geleidersets
- Cap. 20 geleiders
- Ruimte tussen geleiders 25mm
- Incl. 5 visbakken voor 7489.5070

KÜHLSCHRANK / TIEFKÜHLSCHRANK

- Isolierschicht 50mm
- Umgebungstemp. +32°C
- Fest installierte Kompressor
- Einschließlich 3 Gitter mit Führungsschiene
- Für maximal 20 Führungsschienen
- Abstand zwischen Führungsschienen 25mm
- Einschließlich 5 Fish behälter für 7489.5070

REFRIGERATOR / FREEZER

- Insulation 50mm
- Ambient temp. +32°C
- Permanently installed compressor
- Incl. 3 grids and set guides
- Cap. 20 guides
- Space between guides 25mm
- Incl. 5 fish trays for 7489.5070

RÉFRIGÉRATEUR / CONGÉLATEUR

- Isolation 50mm
- Temp. ambiente +32°C
- Compresseur fixé
- 3 Grilles et Glissières inclus
- Cap. 20 Glissières
- Espace entre les Glissières 25mm
- 5 bac poisson inclus pour 7489.5070

Ventilation

Pizzeria

7489.0508 € 50,-

Grids

7489.0900 € 90,-

Castors set (4x)

60Hz ON REQUEST

Bakery



REFRIGERATOR SS GLASS DOOR



60 mm

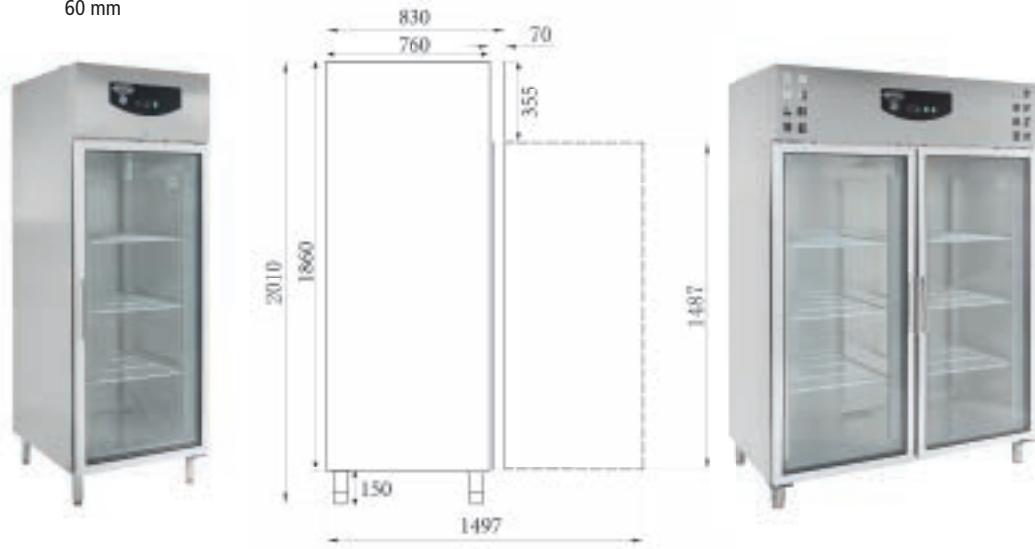

7450.0152

€ 2.075,-

7450.0154

€ 3.165,-

	740 x 830 x 2010	1480 x 830 x 2010
	624 x 685 x 1396	1360 x 685 x 1390
	230 V / 0,58 kW	230 V / 0,53 kW
	597 L	1325 L
	+2/+8°C	+2/+8°C
	R 290	R 290
	138	208

KOELKAST RVS GLASDEUR

- Isolatie 60mm
- Omgevingstemp. +30°C
- Vast ingebouwde compressor
- Incl. 3 roosters 2/1 GN en geleidersets per deur
- Cap. 23 geleiders per deur
- Ruimte tussen geleiders 80mm

KÜHLSCHRANK EDELSTAHL GLASTÜR

- Isolierschicht 60mm
- Umgebungstemp. +30°C
- Fest installierte Kompressor
- Einschließlich 3 Gitter 2/1 GN mit Führungsschiene hinter jeden Tür
- Für maximal 23 Führungsschienen
- Abstand zwischen Führungsschienen 80mm

REFRIGERATOR SS GLASS DOOR

- Insulation 60mm
- Ambient temp. +30°C
- Permanently installed compressor
- Incl. 3 grids 2/1GN and set guides per door
- Cap. 23 guides per door
- Space between guides 80mm

RÉFRIGÉRATEUR EN ACIER INOX PORTE EN VERRE

- Isolation 60mm
- Temp. ambiente +30°C
- Compresseur fixé
- 3 Grilles 2/1GN et Glissières par porte inclus
- Cap. 23 Glissières par porte
- Espace entre les Glissières 80mm

7450.0502 € 27,-



Grids PE coated

GN 2/1GN

7020.1205 € 45,-



Grids SS

GN 2/1GN

7451.0010 € 83,-



Castors set

7450.0501 € 39,-



Set guides



REFRIGERATOR SS GLASS DOOR

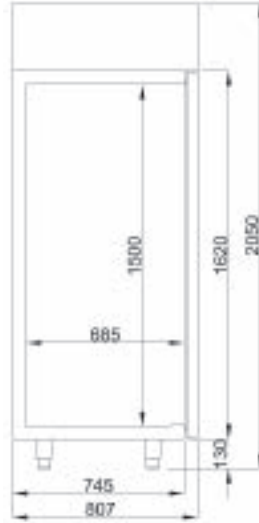

Cooking range

Drop-in

Ovens

Kitchen equipment

7489.5020 7489.5025

€ 2.555,- € 4.460,-

	700 x 810 x 2050	1400 x 810 x 2050
	230 V / 0,20 kW	230 V / 0,30 kW
	700 L	1400 L
	-2/-8°C	-2/+8°C
	R 290	R 290
	145	232

Refrigeration

Dishwashers

Neutral

KOELKAST RVS GLASDEUR Monoblock

- Isolatie 60 mm
- Omgevingstemp. +43°C
- Incl. 3 roosters 2/1GN en geleidersets per deur
- Cap. 31 geleiders per deur
- Ruimte tussen geleiders 45 mm

KÜHLSCHRANK EDELSTAHL GLASTÜR Monoblock

- Isolierschicht 60 mm
- Umgebungstemp. +43°C
- Einschließlich 3 Gitter 2/1GN mit Führungsschiene hinter jeden Tür
- Für maximal 31 Führungsschienen
- Abstand zwischen Führungsschienen 45 mm

REFRIGERATOR SS GLASS DOOR Monoblock

- Insulation 60 mm
- Ambient temp. +43°C
- Incl. 3 grids 2/1GN and set guides per door
- Cap. 31 guides per door
- Space between guides 45 mm

RÉFRIGÉRATEUR EN ACIER INOX PORTE EN VERRE Monoblock

- Isolation 60 mm
- Temp. ambiente +43°C
- 3 Grilles 2/1GN et Glissières par porte inclus
- Cap. 31 Glissières par porte
- Espace entre les Glissières 45 mm

Faucets

Ventilation

Pizzeria

60Hz ON REQUEST

7489.0505 € 65,-

	Grids
>	7489.5020

7489.0514 € 65,-

	Grids
>	7489.5025

7489.0900 € 90,-

	Castors set (4x)
>	7489.5020

7489.0905 € 90,-

	Castors set (5x)
>	7489.5025

Bakery



Refrigeration

STANDARD LINE

FREEZER SS GLASS DOOR



60 mm

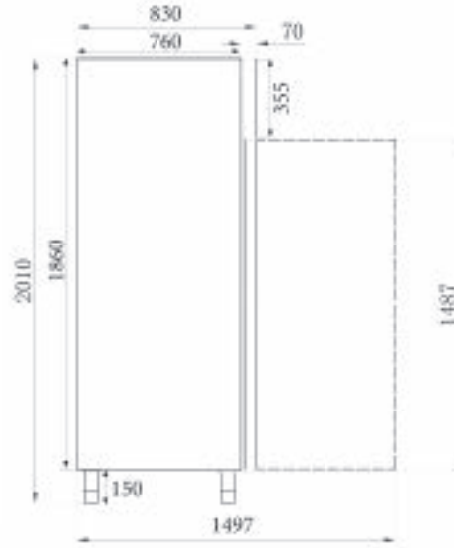

7450.0150

€ 2.780,-



	740 x 830 x 2010
	624 x 685 x 1396
	230 V / 0,75 kW
	597 L
	-18/-22°C
	R 290
	153

VRIESKAST RVS GLASDEUR

- Isolatie 60mm
- Omgevingtemp. +30°C
- Vast ingebouwde compressor
- Incl. 3 roosters 2/1 GN en geleidersets per deur
- Cap. 23 geleiders per deur
- Ruimte tussen geleiders 80mm

TIEFKÜHLSCHRANK EDELSTAHL GLASTÜR

- Isolierschicht 60 mm
- Umgebungtemp. +30°C
- Fest installierte Kompressor
- Einschließlich 3 Gitter 2/1 GN mit Führungsschiene hinter jeden Tür
- Für maximal 23 Führungsschienen
- Abstand zwischen Führungsschienen 80mm

FREEZER SS GLASS DOOR

- Insulation 60mm
- Ambient temp. +30°C
- Permanently installed compressor
- Incl. 3 grids 2/1GN and set guides per door
- Cap. 23 guides per door
- Space between guides 80mm

CONGÉLATEUR EN ACIER INOX PORTE EN VERRE

- Isolation 60mm
- Temp. ambiente +30°C
- Compresseur fixé
- 3 Grilles 2/1GN et Glissières par porte inclus
- Cap. 23 Glissières par porte
- Espace entre les Glissières 80mm

7450.0502 € 27,-



Grids PE coated

GN 2/1GN

7020.1205 € 45,-



Grids SS

GN 2/1GN

7451.0010 € 83,-



Castors set

7450.0501 € 39,-



Set guides



FREEZER SS GLASS DOOR

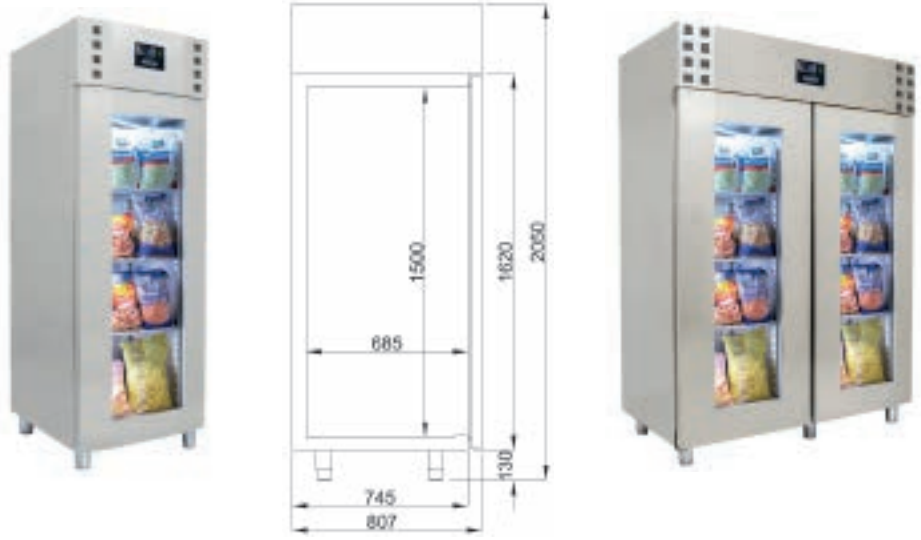

Cooking range

Drop-in

Ovens

Kitchen equipment

7489.5030 **7489.5035**

€ 3.410,- **€ 6.150,-**

	700 x 810 x 2050	1400 x 810 x 2050
	230 V / 0,60 kW	230 V / 0,65 kW
	700 L	1400 L
	-10/-22°C	-10/-22°C
	R 290	R 290
	160	260

Refrigeration

Dishwashers

Neutral

VRIESKAST RVS GLASDEUR

Monoblock

- Isolatie 60 mm
- Omgevingstemp. +43°C
- Incl. 3 roosters 2/1GN en geleidersets per deur
- Cap. 31 geleiders per deur
- Ruimte tussen geleiders 45 mm

TIEFKÜHLSCHRANK EDELSTAHL GLASTÜR

Monoblock

- Isolierschicht 60 mm
- Umgebungstemp. +43°C
- Einschließlich 3 Gitter 2/1GN mit Führungsschiene hinter jeden Tür
- Für maximal 31 Führungsschienen
- Abstand zwischen Führungsschienen 45 mm

FREEZER SS GLASS DOOR

Monoblock

- Insulation 60 mm
- Ambient temp. +43°C
- Incl. 3 grids 2/1GN and set guides per door
- Cap. 31 guides per door
- Space between guides 45 mm

CONGÉLATEUR EN ACIER INOX PORTE EN VERR

Monoblock

- Isolation 60 mm
- Temp. ambiente +43°C
- 3 Grilles 2/1GN et Glissières par porte inclus
- Cap. 31 Glissières par porte
- Espace entre les Glissières 45 mm

Faucets

Ventilation

Pizzeria

60Hz ON REQUEST

7489.0505 **€ 65,-**

	Grids
>	7489.5030

7489.0514 **€ 65,-**

	Grids
>	7489.503

7489.0900 **€ 90,-**

	Castors set (4x)
>	7489.5030

7489.0905 **€ 90,-**

	Castors set (5x)
>	7489.5035

Bakery



REFRIGERATOR/FREEZER



60 mm

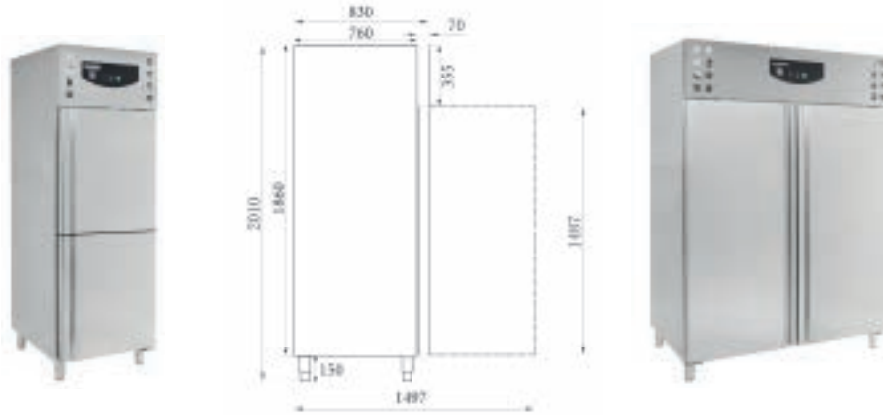

	7450.0715	7450.0720
	€ 2.495,-	€ 3.990,-
	740 x 830 x 2010	1480 x 830 x 2010
	2x 560 x 650 x 650	2x 560 x 653 x 1386
	230 V / 0,58 kW	230V / 0,9kW
	2x 237 L	2x 507 L
	-2/+8°C - 18/-22°C	-2/+8°C - 18/-22°C
	R 600 A / R 290	R 290
GN	4x 2/1 GN	6x 2/1 GN
	150	195

KOEL- / VRIEKAST RVS

- Isolatie 60mm
- Omgevingstemperatuur +32°C
- Koel - vries combinatie
- 2 Compressoren
- 7450.0715: Incl. 2 roosters 2/1GN en geleidersets per deur
- 7450.0720: Incl. 3 roosters 2/1GN en geleidersets per deur
- Digitale display
- Voorzien van slot
- Ruimte tussen geleiders 55mm

KÜHL- / TIEFKÜHL-SCHRANK EDELSTAHL

- Isolierung 60mm
- Umgebungstemperatur +32°C
- Kühl- Tiefkühlkombination
- 2 Kompressor
- 7450.0715: Inkl. 2 Gitter 2/1GN und Führungsschienen pro Tür
- 7450.0720: Inkl. 3 Gitter 2/1GN und Führungsschienen pro Tür
- Digitalanzeige
- Abschließbar
- Abstand zwischen Führungsschienen 55mm

REFRIGERATOR / FREEZER SS

- Insulation 60mm
- Ambient temperature +32°C
- Cool - freeze combination
- 2 Compressors
- 7450.0715: Incl. 2 grids 2/1GN and guide sets per door
- 7450.0720: Incl. 3 grids 2/1GN and guide sets per door
- Digital display
- Provided with lock
- Space between guids 55mm

RÉFRIGÉRATEUR / CONGÉ-LATEUR EN ACIER INOX

- Isolation 60mm
- Température ambiante +32°C
- Combinaison froid-congélation
- 2 compresseurs
- 7450.0715: Incl. 2 grilles 2/1GN et jeux de guides par porte
- 7450.0720: Incl. 3 grilles 2/1 GN et jeux de guides par porte
- Affichage numérique
- Fourni avec serrure
- Espace entre les guides 55mm

7450.0502 **€ 27,-**

	Grids PE coated
GN	2/1GN

7020.1205 **€ 45,-**

	Grids SS
GN	2/1GN

7451.0010 **€ 83,-**

	Castors set
--	-------------

7450.0501 **€ 39,-**

	Set guides
--	------------



REFRIGERATOR/FREEZER



7489.5040	7489.5045	7489.5050	7489.5055
€ 2.295,-	€ 3.315,-	€ 2.690,-	€ 3.905,-

	REFRIGERATOR	REFRIGERATOR	FREEZER	FREEZER
	700 x 710 x 2050	1400 x 700 x 2050	700 x 710 x 2050	1400 x 700 x 2050
	230 V / 0,13 kW	230 V / 0,20 kW	230 V / 0,57 kW	230 V / 0,50 kW
	550 L	1200 L	550 L	1200 L
	-2/+8°C	-2/+8°C	-10/-22°C	-10/-22°C
	R 290	R 290	R 290	R 290
	3x	6x	3x	6x
	133	190	138	210

KOELKAST / VRIESKAST RVS

- Geforceerde koeling
- Isolatie 60 mm
- Omgevingstemperatuur 43°C
- Max. aantal set geleiders 29 per deur
- Incl. 3 Roosters 2/1GN per deur
- Afmeting rooster 530 x 565mm
- Afstand tussen geleiders 45 mm
- Vast ingebouwde compressor
- Voorzien van slot
- Digitale display
- Met verlichting

KÜHLSCHRANK / TIEFKÜHLSCHRANK EDELSTAHL

- Umluft Kühlung
- Isolierschicht 60 mm
- Umgebungstemperatur 43°C
- Max. Paar Führungsschienen 29 pro Tür
- Inkl. 3 Gitter 2/1GN pro Tür
- Abmessungen Gitter 530 x 565mm
- Abstand zwischen Führungsschienen 45 mm
- Fest installierte Kompressor
- Abschließbar
- Digitalanzeige
- Mit Beleuchtung

REFRIGERATOR / FREEZER SS

- Ventilated cooling
- Insulation 60 mm
- Ambient temperature +43 °C
- Max. set guides 29 per door
- Incl. 3 grids 2/1GN per door
- Dimensions shelves 530 x 565mm
- Space between guides 45 mm
- Permanently installed compressor
- Lock
- Digital display
- With lighting

RÉFRIGÉRATEUR / CONGÉLATEUR EN ACIER INOX

- Froid renforcé
- Isolation 60 mm
- Température ambiante +43°C
- Guides, Max 29 par porte
- 3 grilles Inc, 2/1GN par porte
- Dimensions étagères 530 x 565mm
- Espace entre les guides 45 mm
- Compresseur installé en permanence
- Fermeture à clé
- Affichage numérique
- Avec éclairage

7489.0507 € 65,-

Grids

7489.0900 € 90,-

Castors set (4x)

> 7489.5040-5050

7489.0905 € 90,-

Castors set (5x)

> 7489.5045-5055

60Hz ON REQUEST



Refrigeration

STANDARD LINE

REFREGIRATOR SS



60 mm

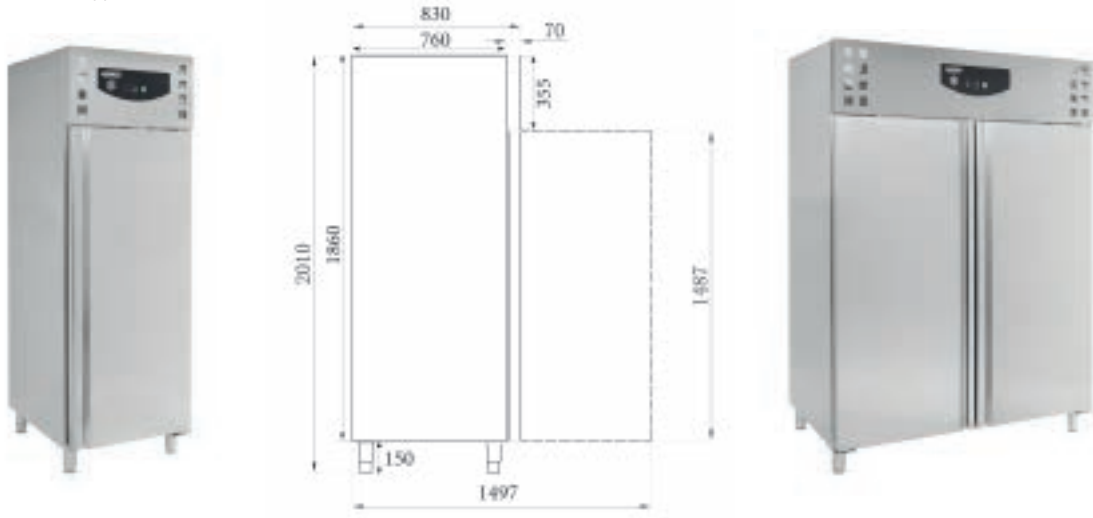

7450.0072

€ 1.480,-

7450.0074

€ 2.390,-

	740 x 830 x 2010	1480 x 830 x 2010
	624 x 685 x 1396	1360 x 685 x 1396
	230 V / 0,45 kW	230 V / 0,45 kW
	650 L	1410 L
	-2/+8°C	-2/+8°C
	R 290	R 290
	120	190

KOELKAST RVS

**Exterieur RVS,
interieur RVS**

- Isolatie 60mm
- Omgevingstemp. +32°C
- Vast ingebouwde compressor
- Incl. 3 roosters 2/1 GN en geleiderset per deur
- Cap. 23 geleiders per deur
- Ruimte tussen geleiders 80mm

KÜHLSCHRANK EDELSTAHL

**Außenseite Edelstahl,
Interieur Edelstahl**

- Isolierschicht 60mm
- Umgebungstemp. +32°C
- Fest installierte Kompressor
- Einschließlich 3 Gitter 2/1 GN mit Führungsschiene hinter jeden Tür
- Für maximal 23 Führungsschienen
- Abstand zwischen Führungsschienen 80mm

REFRIGERATOR SS

**Exterior SS,
Interior SS**

- Insulation 60mm
- Ambient temp. +32°C
- Permanently installed compressor
- Incl. 3 grids 2/1GN and set guides per door
- Cap. 23 guides per door
- Space between guides 80mm

RÉFRIGÉRATEUR EN ACIER INOX

**Extérieur inox,
Intérieur inox**

- Isolation 60mm
- Temp. ambiente +32°C
- Compresseur fixé
- 3 Grilles 2/1GN et Glissières par porte inclus
- Cap. 23 Glissières par porte
- Espace entre les Glissières 80mm

7450.0502 € 27,-



Grids PE coated

GN 2/1GN

7020.1205 € 45,-



Grids SS

GN 2/1GN

7451.0010 € 83,-



Castors set (5x)

> 7489.5005

7950.5021 € 45,-



Set guides



REFREGIRATOR SS



Cooking range
Drop-in
Ovens
Kitchen equipment

7489.5000 7489.5005

€ 2.225,- € 3.145,-

	700 x 810 x 2050	1400 x 810 x 2050
	230 V / 0,05 kW	230 V / 0,07 kW
	700 L	1400 L
	-2/+8°C	-2 / +8°C
	R 290	R 290
	138	217

Refrigeration
Dishwashers
Neutral

KOELKAST RVS

Monoblock

- Isolatie 60mm
- Omgevingstemp. +43°C
- Incl. 3 roosters 2/1 GN en geleidersets per deur
- Cap. 31 geleiders per deur
- Ruimte tussen geleiders 45 mm

KÜHLSCHRANK EDELSTAHL

Monoblock

- Isolierschicht 60 mm
- Umgebungstemp. +43°C
- Einschließlich 3 Gitter 2/1 GN mit Führungsschiene hinter jeden Tür
- Für maximal 31 Führungsschienen
- Abstand zwischen Führungsschienen 45 mm

RÉFRIGÉRATEUR SS

Monoblock

- Isolation 60 mm
- Temp. ambiente +43°C
- 3 Grilles 2/1 GN et Glissières par porte inclus
- Cap. 31 Glissières par porte
- Espace entre les Glissières 45 mm

RÉFRIGÉRATEUR EN ACIER INOX

Monoblock

- Insulation 60 mm
- Ambient temp. +43°C
- Incl. 3 grids 2/1 GN and set guides per door
- Cap. 31 guides per door
- Space between guides 45 mm

Faucets
Ventilation
Pizzeria

60Hz ON REQUEST

7489.0505 € 65,-

	Grids
>	7489.5000

7489.0514 € 65,-

	Grids
>	7489.5005

7489.0900 € 90,-

	Castors set (4x)
>	7489.5000

7489.0905 € 90,-

	Castors set (5x)
>	7489.5005

Bakery



Refrigeration

STANDARD LINE

FREEZER SS

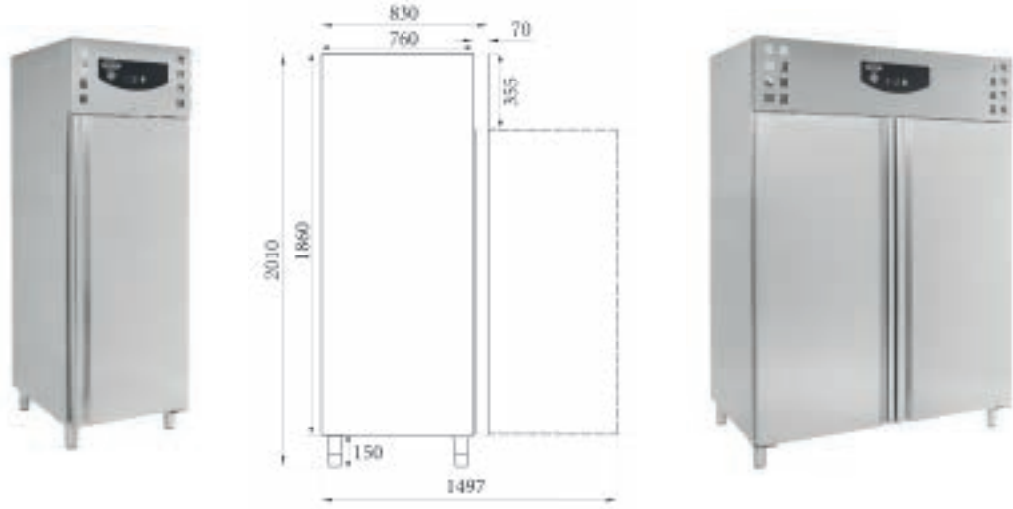

Refrigerators & Freezer Cabinets

Refrigerated & Freezer Counters

Saladettes

Coldrooms

Chest Freezers

Display Refrigeration

Ice Machines

	7450.0076	7450.0078
	€ 1.835,-	€ 2.780,-
	740 x 830 x 2010	1480 x 830 x 2010
	624 x 685 x 1396	1360 x 685 x 1396
	230 V / 0,75 kW	230 V / 1 kW
	650 L	1410 L
	-18/-25°C	-18/-25°C
	R 290	R 290
	130	200

VRIESKAST RVS

**Exterieur RVS,
interieur RVS**

- Isolatie 60 mm
- Omgevingstemp. +32°C
- Vast ingebouwde compressor
- Incl. 3 roosters 2/1GN en geleiderset per deur
- Cap. 23 geleiders per deur
- Ruimte tussen geleiders 80 mm

KÜHLSCHRANK EDELSTAHL

**Außenseite Edelstahl,
Interieur Edelstahl**

- Isolierschicht 60 mm
- Umgebungstemp. +32°C
- Fest installierte Kompressor
- Einschließlich 3 Gitter 2/1GN mit Führungsschiene hinter jeden Tür
- Für maximal 23 Führungsschienen
- Abstand zwischen Führungsschienen 80 mm

FREEZER SS

**Exterior SS,
Interior SS**

- Insulation 60 mm
- Ambient temp. +32°C
- Permanently installed compressor
- Incl. 3 grids 2/1GN and set guides per door
- Cap. 23 guides per door
- Space between guides 80 mm

CONGÉLATEUR EN ACIER INOX

**Extérieur inox,
Intérieur inox**

- Isolation 60 mm
- Temp. ambiente +32°C
- Compresseur fixé
- 3 Grilles 2/1GN et Glissières par porte inclus
- Cap. 23 Glissières par porte
- Espace entre les Glissières 80 mm

7450.0502		€ 27,-
	Grids PE coated	
GN	2/1GN	

7020.1205		€ 45,-
	Grids SS	
GN	2/1GN	

7451.0010		€ 83,-
	Castors set	

7950.5021		€ 45,-
	Set guides	



FREEZER SS



Cooking range

Drop-in

Ovens

Kitchen equipment

7489.5010	7489.5015
-----------	-----------

€ 2.545,-	€ 3.800,-
------------------	------------------

	700 x 810 x 2050	1400 x 810 x 2050
	230 V / 0,24 kW	230 V / 0,45 kW
	700 L	1400 L
	-10/-22°C	-10/ -22°C
	R 290	R 290
	145	231

Refrigeration

Dishwashers

Neutral

VRIESKAST RVS

Monoblock

- Isolatie 60mm
- Omgevingstemp. +43°C
- Incl. 3 roosters 2/1GN en geleidersets per deur
- Cap. 31 geleiders per deur
- Ruimte tussen geleiders 45mm

TIEFKÜHLSCHRANK EDELSTAHL

Monoblock

- Isolierschicht 60mm
- Umgebungstemp. +43°C
- Einschließlich 3 Gitter 2/1GN mit Führungsschiene hinter jeden Tür
- Für maximal 31 Führungsschienen
- Abstand zwischen Führungsschienen 45mm

FREEZER SS

Monoblock

- Insulation 60mm
- Ambient temp. +43°C
- Incl. 3 grids 2/1GN and set guides per door
- Cap. 31 guides per door
- Space between guides 45mm

CONGÉLATEUR EN ACIER INOX

Monoblock

- Isolation 60mm
- Temp. ambiente +43°C
- 3 Grilles 2/1GN et Glissières par porte inclus
- Cap. 31 Glissières par porte
- Espace entre les Glissières 45mm

Faucets

Ventilation

Pizzeria

60Hz ON REQUEST

7489.0505 **€ 65,-**

	Grids
>	7489.5010

7489.0514 **€ 65,-**

	Grids
>	7489.5015

7489.0900 **€ 90,-**

	Castors set (4x)
>	7489.5010

7489.0905 **€ 90,-**

	Castors set (5x)
>	7489.5015

Bakery



REFRIGERATOR SS

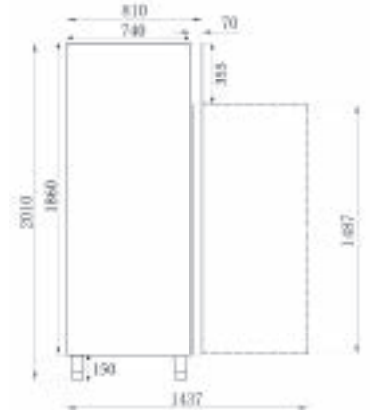

7450.0400

7450.0405

€ 1.330,-

€ 1.990,-

	680 x 800 x 2010	1340 x 800 x 2010
	560 x 653 x 1386	1220 x 653 x 1386
	230 V / 0,45 kW	230 V / 0,45 kW
	600 L	1200 L
	-2/+8°C	-2/+8°C
	R 600 A	R 290
	Automatic	Automatic
	3x 2/1GN	6x 2/1GN
	140	190

🇳🇱 KOELKAST RVS

**Exterieur RVS
interieur aluminium**

- Statische koeler met hulp ventilator
- Verrijdbaar
- Interieur Aluminium
- Behuizing RVS
- Verstelbare roosters
- Cap. 21 geleiders per deur
- Ruimte tussen geleiders 55 mm
- Voorzien van slot
- Isolatie 60 mm

🇩🇪 KÜHLSCHRANK EDELSTAHL

**Außenseite Edelstahl
Interieur Aluminium**

- Statische Kühlung mit Ventilator
- Auf Räder
- Innenseite Aluminium
- Gehäuse Edelstahl
- Einstellbare Gitter austauschbar
- Kapazität 21 Paar Führungsschienen pro Tür
- Abstand zwischen Führungsschienen 55 mm
- Abschließbar
- Isolierschicht 60 mm

🇬🇧 REFRIGERATOR SS

**Exterior SS
Interior Aluminium**

- Static cooler, fan assisted
- Mobile
- Aluminium interior
- Outside stainless steel
- Adjustable shelves
- Capacity 21 guides per door
- Space between guides 55 mm
- Lock
- Insulation 60 mm

🇫🇷 RÉFRIGÉRATEUR EN ACIER INOX

**Extérieur inox
Intérieur Aluminium**

- Refroidisseur statique, assisté par ventilateur
- Mobile
- Intérieur en aluminium
- Extérieur en acier inoxydable
- Tablettes réglables
- Capacité 21 guides par porte
- Espace entre les guides 55 mm
- Fermeture à clé
- Isolation 60 mm

7450.0502 € 27,-

	Grids PE coated
GN	2/1GN

7020.1205 € 45,-

	Grids SS
GN	2/1GN

7450.0501 € 39,-

	Set guides
--	------------



FREEZER SS

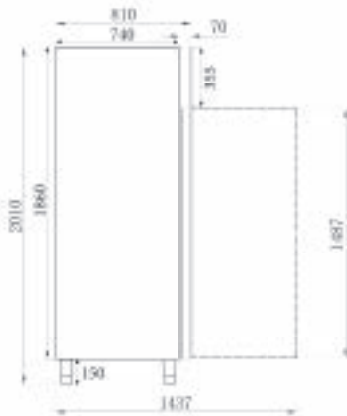

Cooking range

Drop-in

Ovens

Kitchen equipment

Refrigeration

Dishwashers

Neutral

Faucets

Ventilation

Pizzeria

Bakery

	7450.0410	7450.0415
	€ 1.710,-	€ 2.220,-
	680 x 800 x 2010	1340 x 800 x 2010
	560 x 653 x 1386	1220 x 653 x 1386
	230 V / 0,75 kW	230 V / 1 kW
	600 L	1200 L
	-10/-20°C	-10/-20°C
	R 290	R 290
	Manuel	Manuel
	3x 2/1GN	6x 2/1GN
	130	190

VRIESKAST RVS

**Exterieur RVS
interieur aluminium**

- Statische koeler met hulp ventilator
- Verrijdbaar
- Interieur Aluminium
- Behuizing RVS
- Verstelbare roosters
- Cap. 21 geleiders per deur
- Ruimte tussen geleiders 55 mm
- Voorzien van slot
- Isolatie 60 mm

**TIEFKÜHL- SCHRANK
EDELSTAHL**

**Außenseite Edelstahl
Interieur Aluminium**

- Statische Kühlung mit Ventilator
- Auf Räder
- Innenseite Aluminium
- Gehäuse Edelstahl
- Einstellbare Gitter austauschbar
- Kapazität 21 Paar Führungsschienen pro Tür
- Abstand zwischen Führungsschienen 55 mm
- Abschließbar
- Isolierschicht 60 mm

FREEZER SS

**Exterior SS
Interior Aluminium**

- Static cooler, fan assisted
- Mobile
- Aluminium interior
- Outside stainless steel
- Adjustable shelves
- Capacity 21 guides per door
- Space between guides 55 mm
- Lock
- Insulation 60 mm

**CON-GÉLATEUR EN
ACIER INOX**

**Extérieur inox
Intérieur Aluminium**

- Refroidisseur statique, assisté par ventilateur
- Mobile
- Intérieur en aluminium
- Extérieur en acier inoxydable
- Tablettes réglables
- Capacité 21 guides par porte
- Espace entre les guides 55 mm
- Fermeture à clé
- Isolation 60 mm

7450.0502 € 27,-

	Grids PE coated
GN	2/1GN

7020.1205 € 45,-

	Grids SS
GN	2/1GN

7450.0501 € 39,-

	Set guides
--	------------



Refrigeration

STANDARD LINE

CHOCOLATE STORAGE REFRIGERATOR

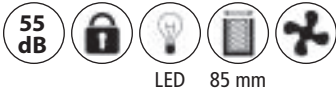

LED 85 mm

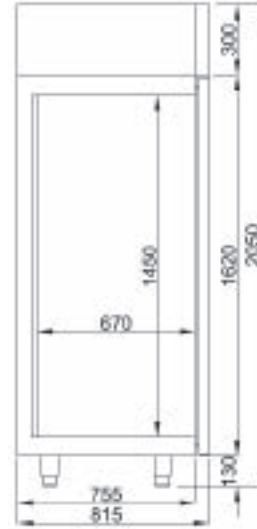

7489.5425

€ 3.490,-



	700 x 810 x 2050
	230 V / 0,25 kW
	700 L
	+12/+18°C
	R 290
	155

CHOCOLADE BEWAARKAST

- Isolatie 85 mm
- Omgevingstemp. +32°C
- Speciale luchtvochtigheidsregelaar, luchtvochtigheid 60%
- Vast ingebouwde compressor
- Incl. 4 roosters 2/1GN en geleiderset
- Cap. 26 geleiders per deur
- Ruimte tussen geleiders 45 mm

SCHOKOLADE KÜHLSCHRANK

- Isolierschicht 85 mm
- Umgebungstemp. +32°C
- Spezielle Feuchtigkeitssteuerung, Maximale Feuchtigkeit 60%
- Fest installierte Kompressor
- Einschließlich 4 Gitter 2/1GN mit Führungsschiene
- Für maximal 26 Führungsschienen
- Abstand zwischen Führungsschienen 45 mm

CHOCOLATE STORAGE REFRIGERATOR

- Insulation 85 mm
- Ambient temp. +32°C
- Special humidity control panel, max. humidity 60%
- Permanently installed compressor
- Incl. 4 grids 2/1GN and set guides
- Cap. 26 guides per door
- Space between guides 45 mm

ARMOIRE RÉFRIGÉRÉE CONSERVATION CHOCOLAT

- Isolation 85 mm
- Temp. ambiente +32°C
- Panneau spécial de contrôle d'humidités, humidité maximum 60%
- Compresseur fixé
- 4 Grilles 2/1GN et Glissières inclus
- Cap. 26 Glissières par porte
- Espace entre les Glissières 45 mm

7489.0552 € 45,-



Grids

7489.0900 € 90,-



Castors set (4x)



WASTE REFRIGERATOR

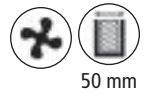

50 mm



Cooking range

Drop-in

Ovens

Kitchen equipment

Refrigeration

Dishwashers

Neutral

Faucets

Ventilation

Pizzeria

Bakery

7489.5615

€ 3.620,-



7489.5620

€ 4.185,-



	1090 x 980 x 1280	1740 x 980 x 1280
	645 x 760 x 1100	1295 x 760 x 1100
	230 V / 0,25 kW	230 V / 0,35 kW
	1x 240 L	2x 240 L
	-2/+8°C	-2/+8°C
	R 290	R 290
	125	175



AFVALKOELEER

- Isolatie 50mm
- Omgevingstemp. +43°C
- Geforceerde koeling
- Automatische ontdooiing
- Ruimte voor 1 afvalcontainer van 240L per deur
- Speciale bodem om met de afruim trolley naar binnen te gaan



ABFALLKÜHLER

- Isolierschicht 50mm
- Umgebungstemp. +43°C
- Umluft Kühlung
- Automatische Abtauung
- Platz für 1 Abfallbehälter à 240L pro Tür
- Spezieller Boden zum Einfahren mit den Abräumwagen



WASTE REFRIGERATOR

- Insulation 50mm
- Ambient temp. +43°C
- Ventilated cooling
- Automatic defrost
- Space for 1 waste container of 240L per door
- Special bottom to enter with the clearing trolley



REFROIDISSEUR DE DÉCHET

- Isolation 50mm
- Temp. ambiente +43°C
- Froid renforcé
- Dégivrage automatique
- Espace pour 1 poubelle de 240L par porte
- Fond spécial pour entrer avec les chariots de vidange

ROLL-IN REFRIGERATOR SS



Refrigerators & Freezer Cabinets

Refrigerated & Freezer Counters

Saladettes

Coldrooms

Chest Freezers

Display Refrigeration

Ice Machines

	7489.5430	7489.5435
	€ 4.400,-	€ 7.400,-
	910 x 1210 x 2210	1820 x 1210 x 2210
	750 x 910 x 1750	1660 x 910 x 1750
	230 V / 0,17 kW	230 V / 0,28 kW
	700 L	1400 L
	-2/+8°C	-2/+8°C
	R 290	R 290
	235	360

ROLL-IN KOELKAST RVS
Monoblock

- Ruimte voor 2/1GN of 600x400 regaalwagens
- Hoogte van trolley max. 145 cm
- Digitaal bedieningspaneel
- Speciale bodem om met de afruim trolley naar binnen te gaan
- Isolatie 80 mm
- Omgevingstemperatuur +43°C

ROLL-IN KÜHLSCHRANK EDELSTAHL
Monoblock

- Platz für 2/1GN oder 600x400 Abräumwagens
- Wagenhöhe max. 145 cm
- Digitales Bedienfeld
- Spezieller Boden zum Einfahren mit den Abräumwagen
- Isolierschicht 80 mm
- Umgebungstemperatur +43°C

ROLL-IN REFRIGERATOR SS
Monoblock

- Space for 2/1GN or 600x400 clearing trolleys
- Trolley height max. 145 cm
- Digital control panel
- Special bottom to enter with the clearing trolley
- Insulation 80 mm
- Ambient temperature +43°C

ROLL-IN RÉFRIGÉRATEUR EN ACIER INOX
Monoblock

- Espace pour 2/1GN ou 600x400 chariots débarrassage
- Hauteur du chariot max. 145 cm
- Panneau de commande numérique
- Fond spécial pour entrer avec les chariots de vidange
- Isolation 80 mm
- Temp. ambiente +43°C



ROLL-IN FREEZER SS



Cooking range

Drop-in

Ovens

Kitchen equipment

Refrigeration

Dishwashers

Neutral

Faucets

Ventilation

Pizzeria

Bakery

7489.5440

€ 5.080,-



7489.5445

€ 8.625,-



	910 x 1210 x 2210	1820 x 1210 x 2210
	750 x 910 x 1750	1660 x 910 x 1750
	230 V / 0,57 kW	230 V / 0,6 kW
	700 L	1400 L
	-10/-20°C	-10/-20°C
	R 290	R 290
	250	375

ROLL-IN VRIESKAST RVS
Monoblock

- Ruimte voor 2/1GN of 600x400 regaalwagens
- Hoogte van trolley max. 145 cm
- Digitaal bedieningspaneel
- Speciale bodem om met de afruim trolley naar binnen te gaan
- Isolatie 80 mm
- Omgevingstemperatuur +43°C

ROLL-IN TIEFKÜHL-SCHRANK EDELSTAHL
Monoblock

- Platz für 2/1GN oder 600x400 Abräumwagens
- Wagenhöhe max. 145 cm
- Digitales Bedienfeld
- Spezieller Boden zum Einfahren mit den Abräumwagen
- Isolierschicht 80 mm
- Umgebungstemperatur +43°C

ROLL-IN FREEZER SS
Monoblock

- Space for 2/1GN or 600x400 clearing trolleys
- Trolley height max. 145 cm
- Digital control panel
- Special bottom to enter with the clearing trolley
- Insulation 80 mm
- Ambient temperature +43°C

ROLL-IN CONGÉLATEUR EN ACIER INOX
Monoblock

- Espace pour 2/1GN ou 600x400 chariots débrassage
- Hauteur du chariot max. 145 cm
- Panneau de commande numérique
- Fond spécial pour entrer avec les chariots de vidange
- Isolation 80 mm
- Temp. ambiente +43°C



Refrigeration

DRY AGE CABINET



60 mm LED

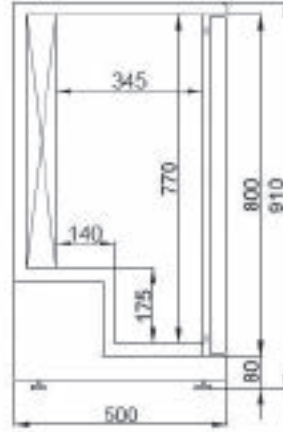

7489.5200

€ 4.460,-



	920 x 550 x 910
	230 V / 0,40 kW
	198 L
	-3/+5°C
	R 290
	2x
	110

DRY AGE KAST

- Incl. 2 Roosters afmeting 845 x 335 mm
- LED verlichting
- Isolatie 60 mm
- Luchtvochtigheid 65%-85%
- Verwarmd glas
- Thermostaat voor interne luchtvochtigheid en temperatuur
- Omgevingstemperatuur +32°C en luchtvochtigheid 40%

DRY AGE SCHRANK

- Inkl. 2 Gitter Abmessungen 845 x 335
- LED Beleuchtung
- Isolierschicht 60 mm
- Feuchtigkeit 65%-85%
- Beheiztes Glas
- Thermostat für Innen Feuchtigkeit und Temperatur
- Umgebungstemperatur +32°C und Feuchtigkeit 40%

DRY AGE CABINET

- Incl. 2 shelves dimensions 845 x 335 mm
- LED Lighting
- Insulation 60 mm
- Humidity 65%-85%
- Special Heated Glass
- Special Control System for Inside Humidity and Temperatur Setting
- Ambient Temperature: +32°C & % 40 Humidity

CAVE A MATURATION

- Incl. 2 étagères dimensions 845 x 335 mm
- Éclairage LED
- Isolation 60 mm
- Humidité 65%-85%
- Verre chauffant spécial
- Système de contrôle spécial pour le réglage de l'humidité intérieure et de la température
- Température ambiante: +32°C et 40% d'humidité

7489.0511 € 150,-



Grids

60Hz



ON REQUEST



DRY AGE CABINET



LED



7525.0100

€ 2.553,-

7525.0105

€ 3.428,-

7525.0110

€ 3.864,-

	595 x 570 x 820	595 x 710 x 1270	595 x 710 x 1720
	230 V 0,14 kW	230 V 0,17 kW	230 V 0,17 kW
	127 L	270 L	388 L
	+1/+25°C	+1/+25°C	+1/+25°C
	R 600 A	R 600 A	R 600 A
	1x 450 x 500 mm	3x 480 x 520 mm	3x 480 x 520 mm
dB	40	41	47
	45 mm	55 mm	55 mm
	45	75	97

DRY AGE KAST

- LED verlichting
- Omgevingstemperatuur +43°C en luchtvochtigheid 65%-85%
- Geventileerd koelsysteem
- Omkeerbare deur
- Isolatie 45mm
- Incl. 1 AISI 304 RVS stang met 3 haken
- Naadloze deur van AISI 304 RVS
- Behuizing zwart gepoedercoat

DRY AGE SCHRANK

- LED Beleuchtung
- Umgebungstemperatur +43°C und Feuchtigkeit 65%-85%
- Umluft Kühlung
- Tür umkehrbar
- Isolierschicht 45mm
- Inkl. 1 Edelstahl 304 Hängestange mit 3 Haken
- Nahtlos Edelstahl 304 Tür
- Gehäuse schwarz pulverbeschichtet

DRY AGE CABINET

- LED Lighting
- Ambient Temperature: +43°C and humidity 65%-85%
- Fan cooling system
- Reversible door
- Insulation 45mm
- Incl. 1 AISI 304 stainless steel hanging rod with 3 hooks
- Seamless AISI 304 stainless steel door
- Housing black powder coated

CAVE A MATURATION

- Éclairage LED
- Température ambiante: +43°C et 65%-85% d'humidité
- Système de refroidissement par ventilateur
- Porte réversible
- Isolation 45mm
- Incl. 1 tige de suspension en acier inoxydable AISI 304 avec 3 crochets
- Porte en acier inoxydable AISI 304 sans soudure
- Revêtement en poudre noir

Cooking range

Drop-in

Ovens

Kitchen equipment

Refrigeration

Dishwashers

Neutral

Faucets

Ventilation

Pizzeria

Bakery



Refrigeration

REFRIGERATOR GLASS DOOR



LED



Refrigerators & Freezer Cabinets

Refrigerated & Freezer Counters

Saladettes

Coldrooms

Chest Freezers

Display Refrigeration

Ice Machines

7455.1385

€ 755,-



7455.1384

€ 770,-



	360 x 422 x 1880	360 x 422 x 1880
	276 x 294 x 1298	276 x 294 x 1298
	230 V / 0,14 kW	230 V / 0,14 kW
	105 L	105 L
	-2/+10°C	-2/+10°C
	R 600 A	R 600 A
	4x	4x
	49	49

KOELKAST GLASDEUR

- LED verlichting
- Statische koeler met hulp ventilator
- Verstelbare roosters
- Omgevingstemperatuur +38°C
- Isolatie 45mm
- Met lichtbox
- Manuele thermostaat
- Behuizing wit/zwart gepoedercoat
- Slank model

KÜHLSCHRANK GLASTÜR

- LED Beleuchtung
- Statische Kühlung mit Ventilator
- Einstellbare Gitter austauschbar
- Umgebungstemperatur +38°C
- Isolierschicht 45mm
- Weiße Frontplatte mit Beleuchtung
- Manuelles Thermostat
- Gehäuse weiß/schwarz pulverbeschichtet
- Schlank Modell

REFRIGERATOR GLASS DOOR

- LED Lighting
- Static cooler, fan assisted
- Adjustable shelves
- Ambient temp. +38°C
- Insulation 45mm
- Incl. Lightbox
- Manual thermostat
- White/black powder coated
- Slim Modell

RÉFRIGÉRATEUR PORTE EN VERRE

- Éclairage LED
- Froid statique, assisté par ventilateur
- Grilles ajustables
- Temp. ambiante +38°C
- Isolation 45mm
- Incl. Bandeau Lumineux
- Thermostat manuel
- Laqué blanc/noir
- Modèle slim

7455.1352 € 8,-

Set guides

GRIDS € 19,-

		7455.1382	7455.1383
>		7455.1384	7455.1385

PRICE CARD HOLDER € 20,-

		7455.2330	7455.2335
>		7455.1384	7455.1385



REFRIGERATOR GLASS DOOR



Cooking range

Drop-in

Ovens

Kitchen equipment

Refrigeration

Dishwashers

Neutral

Faucets

Ventilation

Pizzeria

Bakery

7464.0200

7464.0205

7464.0210

€ 1.050,-

€ 1.050,-

€ 1.160,-

	450 x 497 x 2024	450 x 497 x 1881	450 x 656 x 2024
	374 x 388 x 1408	374 x 388 x 1441	374 x 551 x 1584
	230 V / 0,21kW	230 V / 0,21kW	230 V / 0,2kW
	232 L	221 L	348 L
	+4/+10°C	+4/+10°C	+4/+10°C
	R 600 A	R 600 A	R 600 A
	4x	4x	4x
	88	78	101

KOELKAST GLASDEUR

- LED verlichting
- Statische koeler met hulp ventilator
- Verstelbare roosters
- Omgevingstemperatuur +32°C
- Isolatie 38mm
- Behuizing zwart gepoedercoat
- Slang model

KÜHLSCHRANK GLASTÜR

- LED Beleuchtung
- Statische Kühlung mit Ventilator
- Einstellbare Gitter austauschbar
- Umgebungstemperatur +32°C
- Isolierschicht 38 mm
- Gehäuse schwarz pulverbeschichtet
- Schlank Modell

REFRIGERATOR GLASS DOOR

- LED Lighting
- Static cooler, fan assisted
- Adjustable shelves
- Ambient temp. +32°C
- Insulation 38 mm
- Black powder coated
- Slim Modell

RÉFRIGÉRATEUR PORTE EN VERRE

- Éclairage LED
- Froid statique, assisté par ventilateur
- Grilles ajustables
- Temp. ambiante +32°C
- Isolation 38 mm
- Laqué noir
- Modèle slim



Refrigeration

REFRIGERATOR COUNTERTOP MODEL



	7013.2575	7013.2570
	€ 340,-	€ 430,-
	474 x 440 x 840	540 x 539 x 847
	230 V / 0,085 kW	230 V / 0,085 kW
	80 L	115 L
	110	161
	+3/+10°C	+3/+10°C
	R 600 A	R 600 A
	28	35

KOELKAST TAFELMODEL

- Incl. verlichting
- Draairichting deur verwisselbaar
- Verstelbare roosters
- Behuizing zwart gepoedercoat
- Manuele thermostaat
- Luxe uitstraling
- Omgevingstemperatuur 32°C

KÜHLSCHRANK TISCH MODELL

- Inkl. Beleuchtung
- Türdrehrichtung austauschbar
- Einstellbare Gitter austauschbar
- Gehäuse schwarz pulverbeschichtet
- Manuelles Thermostat
- Luxuriöses Aussehen
- Umgebungstemperatur 32°C

REFRIGERATOR COUNTERTOP MODEL

- Lights included
- Reversible solid door
- Adjustable grids
- Black powder coated
- Manual thermostat
- Luxurious appearance
- Ambient temp. 32°C

RÉFRIGÉRATEUR MODÈLE DE TABLE

- Lumières incluses
- Porte pleine réversible
- Grilles réglables
- Revêtement en poudre noire
- Thermostat manuel
- Aspect luxueux
- Temp. ambiante 32°C



REFRIGERATOR COUNTERTOP MODEL

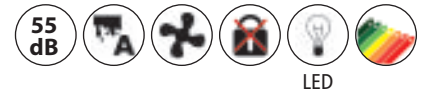

LED



7464.0015

€ 710,-



	500 x 585 x 885
	430 x 436 x 774
	230 V / 0,145 kW
	136 L
	+4/+10°C
	R 600 A
	2x
	50

**KOELKAST
TAFELMODEL**

- LED verlichting
- Verstelbare roosters
- Geforceerde koeling
- Omgevingstemperatuur +32°C
- Isolatie 38 mm
- Behuizing zwart gepoedercoat

**KÜHLSCHRANK
TISCH MODELL**

- LED Beleuchtung
- Einstellbare Gitter austauschbar
- Umluft Kühlung
- Umgebungstemperatur +32°C
- Isolierschicht 38 mm
- Gehäuse schwarz
- pulverbeschichtet

**REFRIGERATOR
COUNTERTOP MODEL**

- LED Lighting
- Adjustable grids
- Ventilated cooling
- Ambient temp. +32°C
- Insulation 38 mm
- Black powder coated

**RÉFRIGÉRATEUR
MODÈLE DE TABLE**

- Éclairage LED
- Grilles réglables
- Froid renforcé
- Temp. ambiante +32°C
- Isolation 38 mm
- Revêtement en poudre noire

Cooking range

Drop-in

Ovens

Kitchen equipment

Refrigeration

Dishwashers

Neutral

Faucets

Ventilation

Pizzeria

Bakery



Refrigeration

MINIBAR



Refrigerators & Freezer Cabinets

Refrigerated & Freezer Counters

Saladettes

Coldrooms

Chest Freezers

Display Refrigeration

Ice Machines

7013.2560

€ 290,-



7013.2565

€ 280,-



	405 x 443 x 545	405 x 443 x 545
	230 V / 0,6 kW	230 V / 0,6 kW
	40 L	40 L
	+6/+12°C	+6/+12°C
	R 600 A	R 600 A
	13,2	13,2

MINI BAR

- Incl. verlichting
- Draairichting deur verwisselbaar
- Absorptiekoeling
- Verstelbare roosters
- Behuizing zwart gepoedercoat
- Manuele thermostaat
- Luxe uitstraling
- Opbergvak aan binnenzijde deur

MINI BAR

- Inkl. Beleuchtung
- Türdrehrichtung austauschbar
- Absorption Kühlung
- Einstellbare Gitter austauschbar
- Gehäuse schwarz pulverbeschichtet
- Manuelle Thermostat
- Luxuriöses Aussehen
- Ablagefach in der Tür

MINI BAR

- Lights included
- Reversible solid door
- Absorption cooling
- Adjustable grids
- Black powder coated
- Manual thermostat
- Luxurious appearance
- Storage compartment inside door

MINI BAR

- Lumières incluses
- Porte pleine réversible
- Refroidissement par absorption
- Grilles réglables
- Revêtement en poudre noire
- Thermostat manuel
- Aspect luxueux
- Compartiment de rangement à l'intérieur de la porte



CAPPUCCINO MILK COOLER



30/35 mm



Cooking range

Drop-in

Ovens

Kitchen equipment

Refrigeration

Dishwashers

Neutral

Faucets

Ventilation

Pizzeria

Bakery

7476.0136

€ 410,-



	220 x 512 x 376
	160 x 190 x 280
	230 V / 0,75 kW
	9 L
	0/+4°C
	R 600 A
	✓
	17

**CAPPUCCINO
MELKKOELER**

- Geforceerde koeling
- Behuizing zwart gepoedercoat
- Deur RVS
- Manuele thermostaat
- Luxe uitstraling

**CAPPUCCINO
MILCHKÜHLER**

- Umluft Kühlung
- Gehäuse schwarz pulverbeschichtet
- Tür Edelstahl
- Manuelles Thermostat
- Luxuriöses Aussehen

**CAPPUCCINO MILK
COOLER**

- Ventilated cooling
- Housing black powder coated
- Stainless steel door
- Manual thermostat
- Luxurious appearance

**CAPPUCCINO
REFROIDISSEUR DE LAIT**

- Froid ventilé
- Revêtement en poudre noire
- Porte en acier inoxydable
- Thermostat manuel
- Aspect luxueux



Refrigeration

REFRIGERATOR 2 GLASS DOOR



LED 45 mm



7455.1390

€ 1.450,-



7455.1392

€ 1.585,-



7455.1394

€ 1.615,-



INT. & EXT. BLACK

	1120 x 595 x 1965	1120 x 595 x 2100	1120 x 595 x 2100
	230 V / 0,45 kW	230 V / 0,45 kW	230 V / 0,45 kW
	750 L	780 L	780 L
	+2/+10°C	+2/+10°C	+2/+10°C
	R 290	R 290	R 290
	113	125	125

KOELKAST GLASDEUREN

- Isolatie 45 mm
- Vast ingebouwde compressor
- Incl. 4 roosters en geleidersets per deur

KÜHLSCHRANK 2 GLASTÜREN

- Isolierschicht 45 mm
- Fest installierte Kompressor
- Einschließlich 4 Gitter mit Führungsschiene hinter jeden Tür

REFRIGERATOR 2 GLASS DOORS

- Insulation 45 mm
- Permanently installed compressor
- Incl. 4 grids and set guides per door

RÉFRIGÉRATEUR 2 PORTES EN VERRE

- Isolation 45 mm
- Compresseur fixé
- 4 Grilles et Glissières par porte inclus

7455.1388 € 7,-

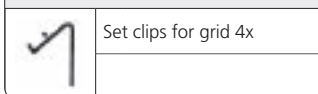

7455.1386 € 28,-

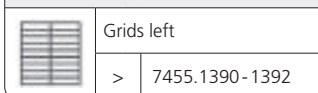

7455.1387 € 28,-



7455.2300 € 28,-

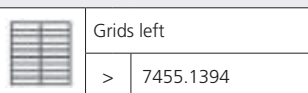

7455.2305 € 28,-





REFRIGERATOR WITH SLIDING GLASS DOORS



Cooking range

Drop-in

Ovens

Kitchen equipment

Refrigeration

Dishwashers

Neutral

Faucets

Ventilation

Pizzeria

Bakery

7455.1395

€ 1.490,-



7455.1396

€ 1.600,-



7455.1398

€ 1.625,-



INT. & EXT. BLACK

	1120 x 595 x 1965	1120 x 595 x 2100	1120 x 595 x 2100
	230 V / 0,45 kW	230 V / 0,45 kW	230 V / 0,45 kW
	750 L	780 L	780 L
	+2/+10°C	+2/+10°C	+2/+10°C
	R 290	R 290	R 290
	113	125	125

KOELKAST SCHUIF GLASDEUREN

- Isolatie 45 mm
- Vast ingebouwde compressor
- Incl. 4 roosters en geleidersets per deur

KÜHLSCHRANK MIT SCHIEBEGLASTÜREN

- Isolierschicht 45 mm
- Fest installierte Kompressor
- Einschließlich 4 Gitter mit Führungsschiene hinter jeden Tür

REFRIGERATOR WITH SLIDING GLASS DOORS

- Insulation 45 mm
- Permanently installed compressor
- Incl. 4 grids and set guides per door

RÉFRIGÉRATEUR AVEC PORTES COULISSANTES EN VERRES

- Isolation 45 mm
- Compresseur fixé
- 4 Grilles et Glissières par porte inclus

7455.1389 € 28,-



Grids

> 7455.1395-1396

7455.2310 € 28,-



Grids

> 7455.1398

7455.1388 € 7,-



Set clips for grid 4x



Refrigeration

REFRIGERATOR WITH SLIDING GLASS DOORS



4x LED



7464.0045

€ 1.820,-



	1103 x 689 x 2000
	1028 x 508 x 1355
	230 V / 0,45 kW
	852 L
	+4/+10°C
	R 290
	159

KOELKAST SCHUIF GLASDEUREN

- LED verlichting
- Schuifdeuren
- Koeler met hulp ventilator
- Verstelbare roosters
- Zwart front, behuizing wit gepoedercoat
- Manuele thermostaat
- Voorzien van slot
- Met lichtbox

KÜHLSCHRANK MIT DOPPELTE SCHIEBEGLASTÜREN

- LED Beleuchtung
- Schiebetüre
- Kühlung mit Ventilator
- Einstellbare Gitter austauschbar
- Front schwarz, Gehäuse weiß pulverbeschichtet
- Manuelles Thermostat
- Abschließbar
- Weiße Frontplatte mit Beleuchtung

REFRIGERATOR WITH SLIDING GLASS DOORS

- LED Lighting
- Sliding doors
- Fan assisted cooler
- Adjustable shelves
- Black front, Housing white powder coated
- Manual thermostat
- Lock
- Incl. Lightbox

RÉFRIGÉRATEUR AVEC PORTES COULISSANTES EN VERRES

- Éclairage LED
- Portes coulissantes
- Réfrigérateur assisté par ventilateur
- Grilles ajustables
- Façade noire, Laqué blanc
- Thermostat manuel
- Fermeture à clé
- Incl. Bandeau lumineux

7464.0046 € 45,-



Grids

> 7464.0045

7464.0037 € 6,-



Set clips for grid 4x



REFRIGERATOR GLASS DOORS



Cooking range

Drop-in

Ovens

Kitchen equipment

Refrigeration

Dishwashers

Neutral

Faucets

Ventilation

Pizzeria

Bakery

7527.0100

€ 1.700,-



7527.0105

€ 1.920,-



7527.0110

€ 1.775,-



7527.0115

€ 1.990,-



- Schuifdeuren • Schiebetüren
- Sliding doors • Portes coulissantes

	1000 x 730 x 2072	1200 x 730 x 2072	1000 x 730 x 2072	1200 x 730 x 2072
	910 x 595 x 1535	1110 x 595 x 1535	910 x 595 x 1535	1110 x 595 x 1535
	230 V / 0,14 kW	230 V / 0,15 kW	230 V / 0,14 kW	230 V / 0,15 kW
	800 L	1000 L	800 L	1000 L
	+2/+10°C	+2/+10°C	+2/+10°C	+2/+10°C
	R 290	R 290	R 290	R 290
	164	199	164	199

KOELKAST GLASDEUR

- LED verlichting
- Geforceerde koeling
- Automatische ontdooiing
- Omgevingstemp. +38°C
- Verstelbare roosters
- Incl. 4 roosters per deur
- Behuizing gepoedercoat
- Voorzien van slot

KÜHLSCHRANK GLASTÜR

- LED Beleuchtung
- Umluft Kühlung
- Automatische Abtauung
- Umgebungstemp. +38°C
- Einstellbare Gitter austauschbar
- Einschließlich 4 Gitter par Tür
- Gehäuse pulverbeschichtet
- Abschließbar

REFRIGERATOR GLASS DOOR

- LED Lighting
- Ventilated cooler
- Automatic defrost
- Ambient temp. +38°C
- Adjustable shelves
- Incl. 4 grids per door
- Housing powder coated
- Lock

RÉFRIGÉRATEUR PORTE EN VERRE

- Éclairage LED
- Froid renforcé
- Dégivrage automatique
- Temp. ambiente +38°C
- Grilles ajustables
- 4 Grilles par porte inclus
- Revêtement en poudre
- Fermeture à clé

GRIDS

€ 25,-

		7527.9105	7527.9110
>		7527.0100-0110	7527.0105-0115

PRICE CARD HOLDER

€ 19,-

		7527.9115	7527.9120
>		7527.0100-0110	7527.0105-0115

7527.9100

€ 6,-

	Set clips for grid 4x
--	-----------------------



Refrigeration

FREEZER GLASS DOOR



LED 60mm



7464.0055

€ 1.695,-

7464.0060

€ 1.760,-

7464.0062

€ 1.695,-

7464.0064

€ 1.760,-

	640 x 670 x 2058	640 x 670 x 2058	640 x 670 x 1875	640 x 670 x 1875
	490 x 469 x 1570	490 x 469 x 1570	490 x 469 x 1570	490 x 469 x 1570
	230 V / 0,25 kW	230 V / 0,67kW	230 V / 0,67kW	230 V / 0,67kW
	382 L	382 L	382 L	382 L
	-18/-24°C	-24/-18°C	-24/-18°C	-24/-18°C
	R 290	R 290	R 290	R 290
	5x	5x	5x	5x
	100	106	96	96

VRIESKAST GLASDEUR

**TIEFKÜHLSCHRANK
GLASTÜR**

FREEZER GLASS DOOR

**CONGÉLATEUR PORTE
EN VERRE**

- LED verlichting
- Statische vriezer
- Vaste roosters
- Omgevingstemperatuur +32°C
- Isolatie 60mm
- Behuizing wit/zwart gepoedercoat
- Deur heeft ruitverwarming

- LED Beleuchtung
- Statische Tiefkühlung
- Feste Gitter
- Umgebungstemperatur +32°C
- Isolierschicht 60mm
- Gehäuse weiß/schwarz pulverbeschichtet
- Tür mit Fensterheizung

- LED Lighting
- Static freezer
- Fixed shelves
- Ambient temp. +32°C
- Insulation 60mm
- White/black powder coated
- Door has window heating

- Éclairage LED
- Congélateur statique
- Grilles fixes
- Temp. ambiante +32°C
- Isolation 60mm
- Laqué blanc/noir
- La porte est munie d'un vitrage chauffant



FREEZER GLASS DOOR



LED 60 mm



Cooking range

Drop-in

Ovens

Kitchen equipment

Refrigeration

Dishwashers

Neutral

Faucets

Ventilation

Pizzeria

Bakery

7464.0050

€ 1.695,-

7464.0052

€ 1.695,-

	494 x 521 x 1951	494 x 521 x 1951
	374 x 388 x 1441	374 x 388 x 1441
	230 V / 0,33kW	230 V / 0,33kW
	221 L	221 L
	-24/-18°C	-24/-18°C
	R 290	R 290
	5x	5x
	88	88

VRIESKAST GLASDEUR

- LED verlichting
- Isolatie 60 mm
- Omgevingstemp. +35°C
- Statische vriezer
- Automatische ontdooiing

TIEFKÜHLCHRANK GLASTÜR

- LED Beleuchtung
- Isolierschicht 60 mm
- Umgebungstemp. +35°C
- Statische Tiefkühlung
- Automatische Abtaugung

FREEZER GLASS DOOR

- LED lighting
- Insulation 60 mm
- Ambient temp. +35°C
- Static freezer
- Automatic defrost

CONGÉLATEUR PORTE EN VERRE

- Éclairage LED
- Isolation 60 mm
- Temp. ambiente +35°C
- Congélateur statique
- Dégivrage automatique



Refrigeration

REFRIGERATOR GLASS DOOR



7464.0088

7464.0093

7464.0085

7464.0090

€ 875,-

€ 895,-

€ 875,-

€ 895,-

- Linksdraaiende deur
- Scharnieren TÜR Linkerseite
- Left rotating door
- Ouverture porte gauche

- Rechtsdraaiende deur
- Scharnieren TÜR Rechterseite
- Right rotating door
- Ouverture porte droite

	595 x 650 x 2000	595 x 650 x 2000	595 x 650 x 2000	595 x 650 x 2000
	490 x 447 x 1570	490 x 447 x 1570	490 x 447 x 1570	490 x 447 x 1570
	230 V / 0.36 kW	230 V / 0.36 kW	230 V / 0.36 kW	230 V / 0.36 kW
	382 L	382 L	382 L	382 L
	+4/+10°C	+4/+10°C	+4/+10°C	+4/+10°C
	R 600 A	R 600 A	R 600 A	R 600 A
	80	80	80	80

KOELKAST GLASDEUR

- LED verlichting
- Statische koeler met hulp ventilator
- Verstelbare roosters
- 7464.0085-0088: Zwart front, behuizing wit gepoedercoat
- 7464.0090-0093: Zwart inside/out
- Manuele thermostaat
- Voorzien van slot

KÜHLSCHRANK GLASTÜR

- LED Beleuchtung
- Statische Kühlung mit Ventilator
- Einstellbare Gitter austauschbar
- 7464.0085-0088: Front schwarz, Gehäuse weiß pulverbeschichtet
- 7464.0090-0093: Innen und Außen schwarz
- Manuelles Thermostat
- Abschließbar

REFRIGERATOR GLASS DOOR

- LED Lighting
- Static cooler, fan assisted
- Adjustable shelves
- 7464.0085-0088: Black front, Housing white powder coated
- 7464.0090-0093: Black inside/outside
- Manual thermostat
- Lock

RÉFRIGÉRATEUR PORTE EN VERRE

- Éclairage LED
- Froid statique, assisté par ventilateur
- Grilles ajustables
- 7464.0085-0088: Façade noire, laqué blanc
- 7464.0090-0093: Intérieur/extérieur Noir
- Thermostat manuel
- Fermeture à clé

GRIDS

€ 25,-

		7464.0086	7464.0091
>		7464.0085-0088	7464.0090-0093

PRICE CARD HOLDER

€ 20,-

		7464.0100	7464.0102
>		7464.0085-0088	7464.0090-0093

7464.0037

€ 6,-

	Set clips for grid 4x
--	-----------------------



REFRIGERATOR GLASS DOOR



Cooking range

Drop-in

Ovens

Kitchen equipment

Refrigeration

Dishwashers

Neutral

Faucets

Ventilation

Pizzeria

Bakery

7464.0094

€ 895,-



7464.0095

€ 870,-



	595 x 650 x 1850	595 x 650 x 1850
	490 x 447 x 1570	490 x 447 x 1570
	230 V / 0.36 kW	230 V / 0.36 kW
	382 L	382 L
	0/+10°C	0/+10°C
	R 600 A	R 600 A
	80	80

KOELKAST GLASDEUR

- LED verlichting
- Statische koeler met hulp ventilator
- Verstelbare roosters
- 7464.0095: Zwart front, behuizing wit gepoedercoat
- 7464.0094: Zwart inside/out
- Manuele thermostaat
- Voorzien van slot

KÜHLSCHRANK GLASTÜR

- LED Beleuchtung
- Statische Kühlung mit Ventilator
- Einstellbare Gitter austauschbar
- 7464.0095: Front schwarz, Gehäuse weiß pulverbeschichtet
- 7464.0094: Innen und Außen schwarz
- Manuelles Thermostat
- Abschließbar

REFRIGERATOR GLASS DOOR

- LED Lighting
- Static cooler, fan assisted
- Adjustable shelves
- 7464.0095: Black front, Housing white powder coated
- 7464.0094: Black inside/outside
- Manual thermostat
- Lock

RÉFRIGÉRATEUR PORTE EN VERRE

- Éclairage LED
- Froid statique, assisté par ventilateur
- Grilles ajustables
- 7464.0095: Façade noire, laqué blanc
- 7464.0094: Interieur/exterieur Noir
- Thermostat manuel
- Fermeture à clé

GRIDS

€ 25,-

		7464.0086	7464.0091
>		7464.0095	7464.0094

PRICE CARD HOLDER

€ 20,-

		7464.0100	7464.0102
>		7464.0095	7464.0094

7464.0037

€ 6,-

	Set clips for grid 4x
--	-----------------------



Refrigeration

REFRIGERATOR / FREEZER



Coolers
Freezers

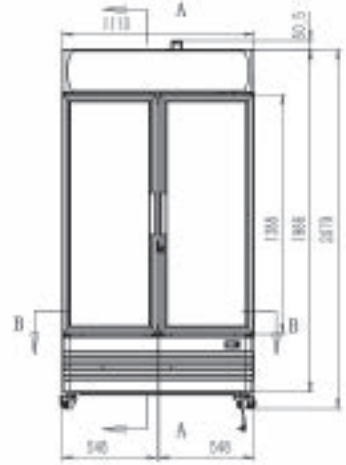

7455.2150

€ 2.690,-



	1110 x 690 x 2079
	1020 x 560 x 1572,5
	230 V / 0,91 kW
	2x 466 L
	0/+10°C, -18/-22°C
	R 290
	158

KOEL/VRIESKAST

- Isolatie 45 mm
- Omgevingstemp. +38°C
- Vast ingebouwde compressor
- Incl. 4 roosters 2/1GN en geleidersets per deur

KÜHL/ TIEFKÜHLSCHRANK

- Isolierschicht 45 mm
- Umgebungstemp. +38°C
- Fest installierte Kompressor
- Einschließlich 4 Gitter 2/1GN mit Führungsschiene

REFRIGERATOR/ FREEZER

- Insulation 45 mm
- Ambient temp. +38°C
- Permanently installed compressor
- Incl. 4 grids 2/1GN and set guides per door

RÉFRIGÉRATEUR/ CONGÉLATEUR

- Isolation 45 mm
- Temp. ambiente +38°C
- Compresseur fixé
- 4 Grilles 2/1GN et Glissières par porte inclus

7455.2151 € 23,-



Grids

7455.2462 € 48,-



Castors set (4x)

7455.2225 € 7,-



Set clips for grid 4x



REFRIGERATOR GLASS DOOR



Cooking range

Drop-in

Ovens

Kitchen equipment

Refrigeration

Dishwashers

Neutral

Faucets

Ventilation

Pizzeria

Bakery

	7455.2104	7455.2105	7455.2110	7455.2115
	€ 740,-	€ 1.395,-	€ 2.250,-	€ 2.290,-
	610 x 610 x 1973	1120 x 610 x 1973	1600 x 610 x 1973	1600 x 610 x 1973
	520 x 480 x 1497,5	1030 x 480 x 1497,5	1510 x 480 x 1497,5	1510 x 480 x 1497,5
	230 V / 0,285 kW	230 V / 0,40 kW	230 V / 0,555 kW	230 V / 0,555 kW
	360 L	670 L	1065 L	1065 L
	+1/+10°C	+1/+10°C	+1/+10°C	+1/+10°C
	R 290	R 290	R 290	R 290
	78	121	180	180

KOELKAST GLASDEUR

- Isolatie 45mm
- Omgevingstemp. +32°C
- Vast ingebouwde compressor
- Incl. 4 roosters 2/1GN en geleidersets per deur
- Cap. 43 geleiders per deur
- Ruimte tussen geleiders 90mm

KÜHLSCHRANK GLASTÜR

- Isolierschicht 45mm
- Umgebungstemp. +32°C
- Fest installierte Kompressor
- Einschließlich 4 Gitter 2/1GN mit Führungsschiene
- Für maximal 43 Führungsschienen
- Abstand zwischen Führungsschienen 90mm

REFRIGERATOR GLASS DOOR

- Insulation 45mm
- Ambient temp. +32°C
- Permanently installed compressor
- Incl. 4 grids 2/1GN and set guides per door
- Cap. 43 guides per door
- Space between guides 90mm

RÉFRIGÉRATEUR PORTE EN VERRE

- Isolation 45mm
- Temp. ambiente +32°C
- Compresseur fixé
- 4 Grilles 2/1GN et Glissières par porte inclus
- Cap. 43 Glissières par porte
- Espace entre les Glissières 90mm

7455.2112 € 60,-

Castors set (4x)

> 7455.2104-2105

7455.2114 € 80,-

Castors set (6x)

> 7455.2110-2115

7455.2225 € 7,-

Set clips for grid 4x

GRIDS							€ 23,-
	7455.2120	7455.2101	7455.2103	7455.2102	7455.2116	7455.2117	
			Grids middle	Grids left & right	Grids middle	Grids left & right	
	> 7455.2104	> 7455.2105	> 7455.2110		> 7455.2115		



Refrigeration

REFRIGERATOR GLASS DOOR



7455.2400

€ 2.150,-

7455.2410

€ 2.970,-

7455.2416 *

€ 4.250,-

NEW!

SIDE BY SIDE

	1253 x 710 x 2092	1880 x 710 x 2092	2580 x 710 x 2092
	1163 x 545 x 1569	1790 x 545 x 1569	2418 x 545 x 1569
	230 V / 0,77 kW	230 V / 0,96 kW	230 V / 1,58 kW
	1000 L	1530 L	2060 L
	0/+10°C	0/+10°C	0/+10°C
	R 290	R 290	R 290
	4x	6x	8x
	202	282	410

(*) EXPORT TRANSPORTKOSTEN OP AANVRAAG | TRANSPORTKOSTEN AUF ANFRAGE | TRANSPORT COSTS ON REQUEST | FRAIS DE TRANSPORT SUR DEMANDE

KOELKAST GLASDEUR

- Isolatie 45 mm
- Omgevingstemp. +38°C
- Vast ingebouwde compressor
- Motor bovenin
- Incl. 5 roosters met prijskaarthouder en geleidersets per deur

KÜHLSCHRANK GLASTÜR

- Isolierschicht 45 mm
- Umgebungstemp. +38°C
- Fest installierte Kompressor
- Motor oben
- Einschließlich 5 Gitter mit Preiskartenhalter und Führungsschiene par Tür

REFRIGERATOR GLASS DOOR

- Insulation 45 mm
- Ambient temp. +38°C
- Permanently installed compressor
- Top mounted cooler
- Incl. 5 grids with price card holders and set guides per door

RÉFRIGÉRATEUR PORTE EN VERRE

- Isolation 45 mm
- Temp. ambiente +38°C
- Compresseur fixé
- Moteur au-dessus
- 5 Grilles avec porte pricecard et Glissières par porte inclus

7455.2226 € 25,-



Grids left & right

7455.2227 € 30,-



Grids middle

> 7455.2410-2416

7455.2280 € 10,-

Shelf partitions L & R

7455.2281 € 10,-

Shelf partitions middle

> 7455.2410-2416

7455.2260 € 12,-

Price card holder L & R

7455.2261 € 15,-

Price card holder middle

> 7455.2410-2416

7455.2225 € 7,-



Set clips for grid 4x

7455.2462 € 48,-



Castors set (4x)

> 7455.2400

7455.2464 € 72,-



Castors set (6x)

> 7455.2410

7455.2466 € 96,-



Castors set (8x)

> 7455.2416



REFRIGERATOR GLASS DOOR



7455.2405

€ 2.150,-

7455.2415

€ 2.990,-

7455.2417 *

€ 4.290,-



SIDE BY SIDE

	1253 x 710 x 2092	1880 x 710 x 2092	2580 x 710 x 2092
	1163 x 545 x 1569	1790 x 545 x 1569	2418 x 545 x 1569
	230 V / 0,77 kW	230 V / 0,96 kW	230 V / 1,58 kW
	1000 L	1530 L	2060 L
	0/+10°C	0/+10°C	0/+10°C
	R 290	R 290	R 290
	4x	6x	8x
	202	282	410

(*) EXPORT TRANSPORTKOSTEN OP AANVRAAG | TRANSPORTKOSTEN AUF ANFRAGE | TRANSPORT COSTS ON REQUEST | FRAIS DE TRANSPORT SUR DEMANDE

KOELKAST GLASDEUR

- Isolatie 45 mm
- Omgevingstemp. +38°C
- Vast ingebouwde compressor
- Motor bovenin
- Incl. 5 roosters met prijskaart-thouder en geleidersets per deur

KÜHLSCHRANK GLASTÜR

- Isolierschicht 45 mm
- Umgebungstemp. +38°C
- Fest installierte Kompressor
- Motor oben
- Einschließlich 5 Gitter mit Preiskartenhalter und Führungsschiene par Tür

REFRIGERATOR GLASS DOOR

- Insulation 45 mm
- Ambient temp. +38°C
- Permanently installed compressor
- Top mounted cooler
- Incl. 5 grids with price card holders and set guides per door

RÉFRIGÉRATEUR PORTE EN VERRE

- Isolation 45 mm
- Temp. ambiente +38°C
- Compresseur fixé
- Moteur au-dessus
- 5 Grilles avec porte pricecard et Glissières par porte inclus

7455.2255 € 25,-

Grids left & right

7455.2256 € 30,-

Grids middle

> 7455.2415 - 2417

7455.2282 € 10,-

Shelf partitions L & R

7455.2283 € 11,-

Shelf partitions middle

> 7455.2415 - 2417

7455.2263 € 11,-

Price card holder L & R

7455.2264 € 13,-

Price card holder middle

> 7455.2415 - 2417

7455.2225 € 7,-

Set clips for grid 4x

7455.2462 € 48,-

Castors set (4x)

> 7455.2405

7455.2464 € 72,-

Castors set (6x)

> 7455.2415

7455.2466 € 96,-

Castors set (8x)

> 7455.2417



Refrigeration

FREEZER GLASS DOOR



Refrigerators & Freezer Cabinets

Refrigerated & Freezer Counters

Saladettes

Coldrooms

Chest Freezers

Display Refrigeration

Ice Machines

7455.2420

€ 3.690,-



7455.2430

€ 4.450,-



7455.2440 *

€ 6.100,-



SIDE BY SIDE

	1253 x 710 x 2092	1880 x 710 x 2092	2508 x 710 x 2092
	1133 x 530 x 1554	1760 x 530 x 1554	2388 x 530 x 1538
	230 V / 1,52 kW	230 V / 1,83 kW	230 V / 2,53 kW
	1000 L	1530 L	2060 L
	-18/-22°C	-18/-22°C	-18/-22°C
	R 290	R 290	R 290
	4x	6x	8x
	264	373	500

(*) EXPORT TRANSPORTKOSTEN OP AANVRAAG | TRANSPORTKOSTEN AUF ANFRAGE | TRANSPORT COSTS ON REQUEST | FRAIS DE TRANSPORT SUR DEMANDE

VRIESKAST GLASDEUR

- Isolatie 60mm
- Omgevingstemp. +32°C
- Vast ingebouwde compressor
- Motor bovenin
- Incl. 5 roosters met prijskaarthouder en geleidersets per deur

TIEFKÜHLSCHRANK GLASTÜR

- Isolierschicht 60mm
- Umgebungstemp. +32°C
- Fest installierte Kompressor
- Motor oben
- Einschließlich 5 Gitter mit Preiskartenhalter und Führungsschiene par Tür

FREEZER GLASS DOOR

- Insulation 60mm
- Ambient temp. +32°C
- Permanently installed compressor
- Top mounted freezer
- Incl. 5 grids with price card holders and set guides per door

CONGÉLATEUR PORTE EN VERRE

- Isolation 60mm
- Temp. ambiente +32°C
- Compresseur fixé
- Moteur au-dessus
- 5 Grilles avec porte pricecard et Glissières par porte inclus

7455.2228 € 25,-



Grids left & right

7455.2229 € 30,-



Grids middle

> 7455.2430-2440

7455.2260 € 12,-

Price card holder L & R

7455.2261 € 15,-

Price card holder middle

> 7455.2430-2440

7455.2225 € 7,-



Set clips for grid 4x

7455.2462 € 48,-



Castors set (4x)

> 7455.2420

7455.2464 € 72,-



Castors set (6x)

> 7455.2430

7455.2466 € 96,-



Castors set (8x)

> 7455.2440



FREEZER GLASS DOOR



7455.2425

€ 3.740,-

7455.2435

€ 4.490,-

7455.2445 *

€ 6.110,-



SIDE BY SIDE

	1253 x 710 x 2092	1880 x 710 x 2092	2508 x 710 x 2092
	1133 x 530 x 1554	1760 x 530 x 1554	2388 x 530 x 1538
	230 V / 1,52 kW	230 V / 1,83 kW	230 V / 2,53 kW
	1000 L	1530 L	2060 L
	-18/-22°C	-18/-22°C	-18/-22°C
	R 290	R 290	R 290
	4x	6x	8x
	264	373	500

(*) EXPORT TRANSPORTKOSTEN OP AANVRAAG | TRANSPORTKOSTEN AUF ANFRAGE | TRANSPORT COSTS ON REQUEST | FRAIS DE TRANSPORT SUR DEMANDE

VRIESKAST GLASDEUR

- Isolatie 60mm
- Omgevingstemp. +32°C
- Vast ingebouwde compressor
- Motor bovenin
- Incl. 5 roosters met prijskaarthouder en geleidersets per deur

TIEFKÜHLSCHRANK GLASTÜR

- Isolierschicht 60mm
- Umgebungstemp. +32°C
- Fest installierte Kompressor
- Motor oben
- Einschließlich 5 Gitter mit Preiskartenhalter und Führungsschiene par Tür

FREEZER GLASS DOOR

- Insulation 60mm
- Ambient temp. +32°C
- Permanently installed compressor
- Top mounted freezer
- Incl. 5 grids with price card holders and set guides per door

CONGÉLATEUR PORTE EN VERRE

- Isolation 60mm
- Temp. ambiente +32°C
- Compresseur fixé
- Moteur au-dessus
- 5 Grilles avec porte pricecard et Glissières par porte inclus

7455.2257 € 25,-

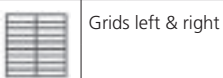

Grids left & right

7455.2258 € 30,-

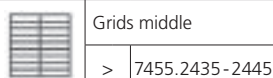

Grids middle

> 7455.2435-2445

7455.2263 € 11,-

Price card holder L & R

7455.2264 € 13,-

Price card holder middle

> 7455.2435-2445

7455.2225 € 7,-

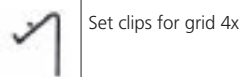

Set clips for grid 4x

7455.2462 € 48,-

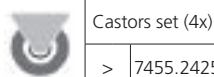

Castors set (4x)

> 7455.2425

7455.2464 € 72,-

Castors set (6x)

> 7455.2435

7455.2466 € 96,-

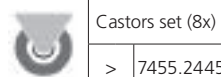

Castors set (8x)

> 7455.2445



Refrigeration

Refrigerators & Freezer Cabinets

Refrigerated & Freezer Counters

Saladettes

Coldrooms

Chest Freezers

Display/Refrigeration

Ice Machines

KOELKAST GLASDEUREN

- Isolatie 45 mm
- Omgevingstemp. +32°C
- Vast ingebouwde compressor
- Incl. 5 roosters en geleidersets per deur
- Cap. 55 geleiders per deur
- Ruimte tussen geleiders 90 mm

7455.2226		€ 25,-
	Grids L & R	
>	7455.2900-2905	

KÜHLSCHRANK GLASTÜREN

- Isolierschicht 45 mm
- Umgebungstemp. +32°C
- Fest installierte Kompressor
- Einschließlich 5 Gitter mit Führungsschiene
- Für maximal 55 Führungsschienen
- Abstand zwischen Führungsschienen 90 mm

7455.2227		€ 30,-
	Grids middle	
>	7455.2905	

REFRIGERATOR GLASS DOORS

- Insulation 45 mm
- Ambient temp. +32°C
- Permanently installed compressor
- Incl. 5 grids and set guides per door
- Cap. 55 guides per door
- Space between guides 90 mm

7455.2260		€ 12,-
	Price card holder L & R	
>	7455.2900-2905	

RÉFRIGÉRATEUR PORTES EN VERRE

- Isolation 45 mm
- Temp. ambiente +32°C
- Compresseur fixé
- 5 Grilles et Glissières par porte inclus
- Cap. 55 Glissières par porte
- Espace entre les Glissières 90 mm

7455.2261		€ 15,-
	Price card holder middle	
>	7455.2905	

7455.2280		€ 10,-
	Shelf partitions L & R	
>	7455.2900-2905	

7455.2281		€ 10,-
	Shelf partitions middle	
>	7455.2905	

7455.2266		€ 40,-
	Castors set (4x)	
>	7455.2900	

7455.2267		€ 80,-
	Castors set (8x)	
>	7455.2905	

7455.2225		€ 7,-
	Set clips for grid (4x)	

VRIESKAST GLASDEUR

- Isolatie 60 mm
- Omgevingstemp. +32°C
- Vast ingebouwde compressor
- Incl. 5 roosters en geleidersets per deur
- Cap. 55 geleiders per deur
- Ruimte tussen geleiders 90 mm

7455.2228		€ 25,-
	Grids L & R	
>	7455.2915-2920	

TIEFKÜHLSCHRANK GLASTÜR

- Isolierschicht 60 mm
- Umgebungstemp. +32°C
- Fest installierte Kompressor
- Einschließlich 5 Gitter mit Führungsschiene
- Für maximal 55 Führungsschienen
- Abstand zwischen Führungsschienen 90 mm

7455.2229		€ 30,-
	Grids middle	
>	7455.2920	

FREEZER GLASS DOOR

- Insulation 60 mm
- Ambient temp. +32°C
- Permanently installed compressor
- Incl. 5 grids and set guides per door
- Cap. 55 guides per door
- Space between guides 90 mm

7455.2260		€ 12,-
	Price card holder L & R	
>	7455.2915-2920	

CONGÉLATEUR PORTE EN VERRE

- Isolation 60 mm
- Temp. ambiente +32°C
- Compresseur fixé
- 5 Grilles et Glissières par porte inclus
- Cap. 55 Glissières par porte
- Espace entre les Glissières 90 mm

7455.2261		€ 15,-
	Price card holder middle	
>	7455.2920	

7455.2266		€ 40,-
	Castors set (4x)	
>	7455.2215	

7455.2267		€ 80,-
	Castors set (8x)	
>	7455.2920	

7455.2225		€ 7,-
	Set clips for grid (4x)	



REFRIGERATOR AND FREEZER WITH GLASS DOORS



7455.2900 | 7455.2915



7455.2905 | 7455.2920



7455.2900	7455.2905	7455.2915	7455.2920
€ 2.350,-	€ 3.360,-	€ 3.790,-	€ 4.790,-

SIDE BY SIDE

	REFRIGERATORS		FREEZERS	
	1253 x 710 x 1997	1880 x 710 x 1997	1253 x 710 x 1997	1880 x 710 x 1997
	1163 x 545 x 1569	1790 x 545 x 1569	1133 x 530 x 1554	1760 x 530 x 1554
	230 V / 0,38 kW	230 V / 0,65 kW	230 V / 1,08 kW	230 V / 1,43 kW
	1000 L	1530 L	1000 L	1450 L
	0/+10°C	0/+10°C	-18/-22°C	-18/-22°C
	R 290	R 290	R 290	R 290
	45	45	60	60
	4x	8x	4x	8x
	197	235	340	400

Cooking range

Drop-in

Ovens

Kitchen equipment

Refrigeration

Dishwashers

Neutral

Faucets

Ventilation

Pizzeria

Bakery



Refrigeration

Refrigerators & Freezer Cabinets

Refrigerated & Freezer Counters

Saladettes

Coldrooms

Chest Freezers

Display Refrigeration

Ice Machines

KOELKAST GLASDEUREN

- Isolatie 45mm
- Omgevingstemp. +32°C
- Vast ingebouwde compressor
- Incl. 5 roosters met prijskaart-houder en geleidersets per deur
- Cap. 55 geleiders per deur
- Ruimte tussen geleiders 90mm

7455.2284		€ 21,-
	Grids	
	>	7455.2212

7455.2288		€ 11,-
	Price card	
	>	7455.2212

7455.2292		€ 10,-
	Shelf partitions	
	>	7455.2212

7455.2266		€ 40,-
	Castors set (4x)	
	>	7455.2200-2212

KÜHLSCHRANK GLASTÜREN

- Isolierschicht 45mm
- Umgebungstemp. +32°C
- Fest installierte Kompressor
- Einschließlich 5 Gitter mit Preiskartenhalter und Führungsschiene par Tür
- Für max. 55 Führungsschienen
- Abstand zwischen Führungsschienen 90mm

7455.2226		€ 25,-
	Grids L & R	
	>	7455.2200-05-10

7455.2260		€ 12,-
	Price card holder L & R	
	>	7455.2200-05-10

7455.2280		€ 10,-
	Shelf partitions L & R	
	>	7455.2200-05-10

7455.2267		€ 80,-
	Castors set (8x)	
	>	7455.2205

REFRIGERATOR GLASS DOORS

- Insulation 45mm
- Ambient temp. +32°C
- Permanently installed compressor
- Incl. 5 grids with price card holders and set guides per door
- Cap. 55 guides per door
- Space between guides 90mm

7455.2227		€ 30,-
	Grids middle	
	>	7455.2205-2210

7455.2261		€ 15,-
	Price card holder middle	
	>	7455.2205-2210

7455.2281		€ 10,-
	Shelf partitions middle	
	>	7455.2205-2210

7455.2268		€ 100,-
	Castors set (10x)	
	>	7455.2210

RÉFRIGÉRATEUR PORTES EN VERRE

- Isolation 45mm
- Temp. ambiente +32°C
- Compresseur fixé
- 5 Grilles avec porte pricecard et Glissières par porte inclus
- Cap. 55 Glissières par porte
- Espace entre les Glissières 90mm

7455.2225		€ 7,-
	Set clips for grid (4x)	

VRIESKAST GLASDEUR

- Isolatie 60mm
- Omgevingstemp. +32°C
- Vast ingebouwde compressor
- Incl. 5 roosters met prijskaarthouder en geleidersets per deur
- Cap. 55 geleiders per deur
- Ruimte tussen geleiders 90mm

7455.2285		€ 21,-
	Grids	
	>	7455.2214

7455.2289		€ 11,-
	Price card	
	>	7455.2214

7455.2266		€ 40,-
	Castors set (4x)	
	>	7455.2214-2215

TIEFKÜHLSCHRANK GLASTÜR

- Isolierschicht 60mm
- Umgebungstemp. +32°C
- Fest installierte Kompressor
- Einschließlich 5 Gitter mit Preiskartenhalter und Führungsschiene par Tür
- Für max. 55 Führungsschienen
- Abstand zwischen Führungsschienen 90mm

7455.2228		€ 25,-
	Grids L & R	
	>	7455.2215-2220

7455.2260		€ 12,-
	Price card holder L & R	
	>	7455.2215-2220

7455.2267		€ 80,-
	Castors set (8x)	
	>	7455.2220

FREEZER GLASS DOOR

- Insulation 60mm
- Ambient temp. +32°C
- Permanently installed compressor
- Incl. 5 grids with price card holders and set guides per door
- Cap. 55 guides per door
- Space between guides 90mm

7455.2229		€ 30,-
	Grids middle	
	>	7455.2220

7455.2261		€ 15,-
	Price card holder middle	
	>	7455.2220

CONGÉLATEUR PORTE EN VERRE

- Isolation 60mm
- Temp. ambiente +32°C
- Compresseur fixé
- 5 Grilles avec porte pricecard et Glissières par porte inclus
- Cap. 55 Glissières par porte
- Espace entre les Glissières 90mm

7455.2225		€ 7,-
	Set clips for grid (4x)	



REFRIGERATOR AND FREEZER WITH GLASS DOORS



7455.2212

7455.2200

7455.2205

7455.2210



7455.2214

7455.2215

7455.2220



7455.2212	7455.2200	7455.2205	7455.2210*	7455.2214	7455.2215	7455.2220
€ 1.770,-	€ 2.590,-	€ 3.640,-	€ 5.200,-	€ 2.780,-	€ 4.390,-	€ 5.350,-

SIDE BY SIDE

	REFRIGERATORS				FREEZERS		
	750 x 710 x 1997	1253 x 710 x 1997	1880 x 710 x 1997	2508 x 710 x 1997	750 x 710 x 1997	1253 x 710 x 1997	1880 x 710 x 1997
	660 x 545 x 1569	1163 x 545 x 1569	1790 x 545 x 1569	2418 x 545 x 1569	630 x 580 x 1538	1133 x 530 x 1554	1760 x 530 x 1554
	230 V / 0,19 kW	230 V / 0,38 kW	230 V / 0,65 kW	230 V / 0,92 kW	230 V / 0,53 kW	230 V / 1,08 kW	230 V / 1,43 kW
	600 L	1000 L	1530 L	2025 L	600 L	1000 L	1450 L
	0/+10°C	0/+10°C	0/+10°C	0/+10°C	-18/-22°C	-18/-22°C	-18/-22°C
	R 290	R 290	R 290	R 290	R 290	R 290	R 290
	45	45	45	45	60	60	60
	4x	4x	8x	10x	4x	4x	8x
	142	197	235	400	159	340	400

(*) EXPORT TRANSPORTKOSTEN OP AANVRAAG | TRANSPORTKOSTEN AUF ANFRAGE | TRANSPORT COSTS ON REQUEST | FRAIS DE TRANSPORT SUR DEMANDE

Cooking range

Drop-in

Ovens

Kitchen equipment

Refrigeration

Dishwashers

Neutral

Faucets

Ventilation

Pizzeria

Bakery



Refrigeration

Refrigerators & Freezer Cabinets

Refrigerated & Freezer Counters

Saladettes

Coldrooms

Chest Freezers

Display Refrigeration

Ice Machines

KOELKAST GLASDEUREN

- Isolatie 45mm
- Omgevingstemp. +32°C
- Vast ingebouwde compressor
- Incl. 5 roosters met prijskaart-houder en geleidersets per deur
- Cap. 55 geleiders per deur
- Ruimte tussen geleiders 90mm

KÜHLSCHRANK GLASTÜREN

- Isolierschicht 45mm
- Umgebungstemp. +32°C
- Fest installierte Kompressor
- Einschließlich 5 Gitter mit Preiskartenhalter und Führungsschiene par Tür
- Für max. 55 Führungsschienen
- Abstand zwischen Führungsschienen 90mm

REFRIGERATOR GLASS DOORS

- Insulation 45mm
- Ambient temp. +32°C
- Permanently installed compressor
- Incl. 5 grids with price card holders and set guides per door
- Cap. 55 guides per door
- Space between guides 90mm

RÉFRIGÉRATEUR PORTES EN VERRE

- Isolation 45mm
- Temp. ambiente +32°C
- Compresseur fixé
- 5 Grilles avec porte pricecard et Glissières par porte inclus
- Cap. 55 Glissières par porte
- Espace entre les Glissières 90mm

7455.2286		€ 21,-
	Grids	
>	7455.2242	

7455.2255		€ 25,-
	Grids L & R	
>	7455.2230-35-40	

7455.2256		€ 30,-
	Grids middle	
>	7455.2235-2240	

7455.2225		€ 7,-
	Set clips for grid (4x)	

7455.2290		€ 11,-
	Price card	
>	7455.2242	

7455.2263		€ 11,-
	Price card holder L & R	
>	7455.2230-35-40	

7455.2264		€ 13,-
	Price card holder middle	
>	7455.2235-2240	

7455.2294		€ 10,-
	Shelf partitions	
>	7455.2242	

7455.2282		€ 10,-
	Shelf partitions L & R	
>	7455.2230-35-40	

7455.2283		€ 11,-
	Shelf partitions middle	
>	7455.2235-2240	

7455.2266		€ 40,-
	Castors set (4x)	
>	7455.2242-2230	

7455.2267		€ 80,-
	Castors set (8x)	
>	7455.2235	

7455.2268		€ 100,-
	Castors set (10x)	
>	7455.2240	

VRIESKAST GLASDEUR

- Isolatie 60mm
- Omgevingstemp. +32°C
- Vast ingebouwde compressor
- Incl. 5 roosters met prijskaarthouder en geleidersets per deur
- Cap. 55 geleiders per deur
- Ruimte tussen geleiders 90mm

TIEFKÜHLSCHRANK GLASTÜR

- Isolierschicht 60mm
- Umgebungstemp. +32°C
- Fest installierte Kompressor
- Einschließlich 5 Gitter mit Preiskartenhalter und Führungsschiene par Tür
- Für max. 55 Führungsschienen
- Abstand zwischen Führungsschienen 90mm

FREEZER GLASS DOOR

- Insulation 60mm
- Ambient temp. +32°C
- Permanently installed compressor
- Incl. 5 grids with price card holders and set guides per door
- Cap. 55 guides per door
- Space between guides 90mm

CONGÉLATEUR PORTE EN VERRE

- Isolation 60mm
- Temp. ambiente +32°C
- Compresseur fixé
- 5 Grilles avec porte pricecard et Glissières par porte inclus
- Cap. 55 Glissières par porte
- Espace entre les Glissières 90mm

7455.2287		€ 21,-
	Grids	
>	7455.2244	

7455.2257		€ 25,-
	Grids L & R	
>	7455.2245-2250	

7455.2258		€ 30,-
	Grids middle	
>	7455.2250	

7455.2225		€ 7,-
	Set clips for grid (4x)	

7455.2291		€ 11,-
	Price card	
>	7455.2244	

7455.2263		€ 11,-
	Price card holder L & R	
>	7455.2245-2250	

7455.2264		€ 13,-
	Price card holder middle	
>	7455.2250	

7455.2266		€ 40,-
	Castors set (4x)	
>	7455.2244-2245	

7455.2267		€ 80,-
	Castors set (8x)	
>	7455.2250	



REFRIGERATOR AND FREEZER WITH GLASS DOORS



LED



7455.2242



7455.2230



7455.2235



7455.2240



7455.2244



7455.2245



7455.2250



7455.2242	7455.2230	7455.2235	7455.2240*	7455.2244	7455.2245	7455.2250
€ 1.785,-	€ 2.600,-	€ 3.690,-	€ 5.250,-	€ 2.790,-	€ 4.415,-	€ 5.370,-

SIDE BY SIDE

	REFRIGERATORS				FREEZERS		
	750 x 710 x 1997	1253 x 710 x 1997	1880 x 710 x 1997	2508 x 710 x 1997	750 x 710 x 1997	1253 x 710 x 1997	1880 x 710 x 1997
	660 x 545 x 1569	1163 x 545 x 1569	1790 x 545 x 1569	2418 x 545 x 1569	630 x 580 x 1538	1133 x 530 x 1554	1760 x 530 x 1554
	230 V / 0,19 kW	230 V / 0,38 kW	230 V / 0,65 kW	230 V / 0,92 kW	230 V / 0,53 kW	230 V / 1,08 kW	230 V / 1,43 kW
	600 L	1000 L	1530 L	2025 L	600 L	1000 L	1450 L
	0/+10°C	0/+10°C	0/+10°C	0/+10°C	-18/-22°C	-18/-22°C	-18/-22°C
	R 290	R 290	R 290	R 290	R 290	R 290	R 290
	45	45	45	45	60	60	60
	4x	4x	8x	10x	4x	4x	8x
	142	197	235	400	159	340	400

(*) EXPORT TRANSPORTKOSTEN OP AANVRAAG | TRANSPORTKOSTEN AUF ANFRAGE | TRANSPORT COSTS ON REQUEST | FRAIS DE TRANSPORT SUR DEMANDE

Cooking range

Drop-in

Ovens

Kitchen equipment

Refrigeration

Dishwashers

Neutral

Faucets

Ventilation

Pizzeria

Bakery



Refrigeration

REFRIGERATOR GLASS DOOR



LED 48 mm

Refrigerators & Freezer Cabinets

Refrigerated & Freezer Counters

Saladettes

Coldrooms

Chest Freezers

Display Refrigeration

Ice Machines



	7526.0005	7526.0010	7526.0015	7526.0020 *
	€ 1.400,-	€ 2.250,-	€ 3.100,-	€ 4.250,-
	620 x 600 x 1980	1100 x 600 x 1980	1680 x 600 x 1980	2240 x 600 x 1980
	524 x 487 x 1459	1024 x 487 x 1459	1584 x 487 x 1459	2144 x 487 x 1459
	230 V / 0,375 kW	230 V / 0,475 kW	230 V / 0,58 kW	230 V / 0,65 kW
	387 L	758 L	1173 L	1608 L
	0/+10°C	0/+10°C	0/+10°C	0/+10°C
	R 290	R 290	R 290	R 290
	100	178	255	330

EXPORT TRANSPORTKOSTEN OP AANVRAAG | TRANSPORTKOSTEN AUF ANFRAGE | TRANSPORT COSTS ON REQUEST | FRAIS DE TRANSPORT SUR DEMANDE

KOELKAST GLASDEUR

- Isolatie 48 mm
- Omgevingstemp. +38°C
- Vast ingebouwde compressor
- Incl. 5 roosters met clips, prijskaarthouder en draadvederler per deur
- Behuizing zwart gepoedercoat

KÜHLSCHRANK GLASTÜR

- Isolierschicht 48 mm
- Umgebungstemp. +38°C
- Fest installierte Kompressor
- Einschließlich 5 Gitter mit clips, Führungsschiene und Drahtteile par Tür

REFRIGERATOR GLASS DOOR

- Insulation 48 mm
- Ambient temp. +38°C
- Permanently installed compressor
- Incl. 5 grids with clips, price card holder and shelf partition per door
- Housing black powder coated

RÉFRIGÉRATEUR PORTE EN VERRE

- Isolation 48 mm
- Temp. ambiente +38°C
- Compresseur fixé
- 5 Grilles, clips, porte pricecard et séparateur de bouteilles par porte inclus
- Revêtement en poudre noir

7526.9000 € 5,-

Set clips for grid 4x

> 7526.0005-0015-0020

7526.9030 € 35,-

Price card holder middle

> 7526.0005-0015-0020

7526.9035 € 35,-

Price card holder L/R

> 7526.0010-0015-0020

7526.9005 € 30,-

Grids middle

> 7526.0005-0015-0020

7526.9010 € 30,-

Grids L & R

> 7526.0010-0015-0020

7526.9020 € 20,-

Shelf partitions middle

> 7526.0010-0015-0020

7526.9025 € 20,-

Shelf partitions L & R

> 7526.0005-0015-0020



FREEZER GLASS DOOR



LED



7295.0070

€ 2.710,-



7295.0075

€ 3.880,-



MARIN

	520 x 740 x 1935	520 x 740 x 1935
	230 V / 0,7 kW	230V / 0,75 kW
	-18°C	-18°C
	R 290	R 290
	✓	X
	X	✓
	353 L	353 L
	7x + 1 bottom	5x + 1 bottom

VRIESKAST GLASDEUR

- LED verlichting
- Automatische ontdooing
- Omgevingstemperatuur +35°C
- 7295.0070: statische vriezer, vaste roosters
- 7295.0075: geventileerde vriezer, verstelbare roosters

TIEFKÜHLSCHRANK GLASTÜR

- LED Beleuchtung
- Automatische Abtauung
- Umgebungstemperatur +35°C
- 7295.0070: Statische Tiefkühlschrank, Feste Gitter
- 7295.0075: Umluft Kühlung, Einstellbare Gitter austauschbar

FREEZER GLASS DOOR

- LED lighting
- Automatic defrost
- Ambient temperature +35°C
- 7295.0070: static freezer, fixed shelves
- 7295.0075: fan cooled freezer, adjustable shelves

CONGÉLATEUR PORTE EN VERRE

- Éclairage LED
- Dégivrage automatique
- Temp. ambiente +35°C
- 7295.0070: congélateur statique, grilles fixes
- 7295.0075: congélateur ventilé, grilles ajustables

Cooking range

Drop-in

Ovens

Kitchen equipment

Refrigeration

Dishwashers

Neutral

Faucets

Ventilation

Pizzeria

Bakery



Refrigeration

Refrigerators & Freezer Cabinets

Refrigerated & Freezer Counters

Saladettes

Coldrooms

Chest Freezers

Display Refrigeration

Ice Machines

FREEZER GLASS DOOR



FREEZER GLASS DOOR



	7450.0156	7450.0157
	€ 2.550,-	€ 3.250,-
	680 x 720 x 1990	1370 x 720 x 1990
	560 x 580 x 1270	1250 x 580 x 1270
	230 V / 0,25 kW	230 V / 0,4 kW
	412 L	920 L
	-18/-24°C	-18/-24°C
	R 290	R 290
dB	50	55
	5x	10x
	138	227

	7450.0165	7450.0167
	€ 2.330,-	€ 3.250,-
	680 x 700 x 1990	1370 x 700 x 1990
	230 V / 0,35 kW	230 V / 0,53 kW
	578 L	1079 L
	-18/-24°C	-18/-24°C
	R 290	R 290
dB	50	55
	5x	10x
	138	227

VRIESKAST GLASDEUR

- LED verlichting
- 7450.0156-0157: Geforceerde koeling, verstelbare roosters
- 7450.0165-0167: Statische vriezer, vaste roosters
- Behuizing wit gepoedercoat
- Digitale thermostaat
- Voorzien van slot
- Draaideur
- Met lichtbox

TIEFKÜHLSCHRANK GLASTÜR

- LED Beleuchtung
- 7450.0156-0157: Umluft Kühlung, Einstellbare Gitter austauschbar
- 7450.0165-0167: Statische Tiefkühlschrank, Feste Gitter
- Gehäuse weiß pulverbeschichtet
- Digitales Thermostat
- Abschließbar
- Drehtür
- Weiße Frontplatte mit Beleuchtung

FREEZER GLASS DOOR

- LED Lighting
- 7450.0156-0157: Ventilated cooling, adjustable shelves
- 7450.0165-0167: Static freezer, fixed shelves
- Housing white powder coated
- Digital thermostat
- Lock
- Hinged door
- Incl. Lightbox

CONGÉLATEUR PORTE EN VERRE

- Éclairage LED
- 7450.0156-0157: Froid ventilé, grilles ajustables
- 7450.0165-0167: Congélateur statique, grilles fixes
- Revêtement en poudre noire
- Thermostat digital
- Fermeture à clé
- Porte battante
- Incl. Bandeau lumineux

7451.0220		€ 21,-
	Grids middle	
>	7450.0156	

7451.0250		€ 21,-
	Grids	
>	7450.0157	

7451.0226		€ 21,-
	Set clips for grid (4x)	
>	7450.0156-0157	

7451.0221		€ 5,-
	Price card holder	
>	7450.0156-0157	



REFRIGERATOR GLASS DOOR



LED



FREEZER GLASS DOOR



LED



7450.0130

€ 1.670,-

7450.0140

€ 2.500,-

SIDE BY SIDE

	680 x 700 x 1990	1370 x 700 x 1990
	230 V	230 V / 0,17 kW
	460 L	1079 L
	+2/+8°C	+2/+8°C
	R 290	R 290
dB	50	55
	4x	8x
	100	150

7450.0135

€ 2.550,-

7450.0145

€ 3.700,-

SIDE BY SIDE

	680 x 700 x 1990	1370 x 700 x 1990
	230 V / 0,36 kW	230 V / 0,5 kW
	460 L	1079 L
	-18/-24°C	-18/-24°C
	R 290	R 290
dB	50	55
	4x	8x
	110	160

KOEL / VRIESKAST GLASDEUR

- LED verlichting
- Digitale display
- Voorzien van slot
- Verstelbare roosters
- Omgevingstemperatuur +32°C
- Isolatie 45mm
- Verrijdbaar
- Draaideur
- Met lichtbox

KÜHL / TIEFKÜHL-SCHRANK GLASTÜR

- LED Beleuchtung
- Digitalanzeige
- Abschließbar
- Einstellbare Gitter austauschbar
- Umgebungstemperatur +32°C
- Isolierschicht 45mm
- Auf Räder
- Drehtür
- Weiße Frontplatte mit Beleuchtung

REFRIGERATOR / FREEZER GLASS DOOR

- LED Lighting
- Digital display
- Lock
- Adjustable shelves
- Ambient temperature +32°C
- Isolation 45mm
- Mobile
- Hinged door
- Incl. Lightbox

RÉFRIGÉRATEUR / CONGÉ-LATEUR PORTE EN VERRE

- Éclairage LED
- Affichage numérique
- Fermeture à clé
- Tablettes réglables
- Température ambiante + 32°C
- Isolation 45mm
- Mobile
- Porte battante
- Incl. Bandeau lumineux

7451.0460 € 20,-

	Grids
>	7450.0130-0135

7451.0465 € 20,-

	Grids
>	7450.0140-0145

7451.0226 € 21,-

	Set clips for grid (4x)
--	-------------------------

7451.0470 € 5,-

	Price card holder
--	-------------------



Refrigeration

COLD DISPLAY



Refrigerators & Freezer Cabinets

Refrigerated & Freezer Counters

Saladettes

Coldrooms

Chest Freezers

Display Refrigeration

Ice Machines

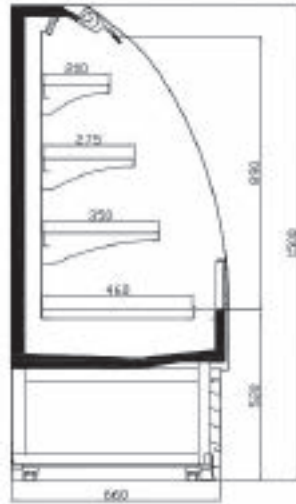

	7080.0005	7080.0010	7080.0015
	€ 3.185,-	€ 3.545,-	€ 3.835,-
	1000x660x1500	1300x660x1500	1500x660x1500
	230 V / 1,2 kW	230 V / 1,29 kW	230V / 1,52 kW
	290 L	380 L	440 L
	-2/+8°C	-2/+8°C	-2/+8°C
	R 290	R 290	R 290
	3x	3x	3x
	120	130	150

KOELVITRINE

- LED verlichting onder elk schap en aan de bovenkant
- Zelfbediening middels open voorzijde
- Met nachtabdekking
- Geventileerd koelsysteem
- Digitale thermostaat
- Automatische ontdooiing
- Omgevingstemperatuur +25°C

KÜHLVITRINE

- LED-Beleuchtung unter jedem Regal und oben
- Selbstbedienung durch offene Front
- Mit Nachtabdeckung
- Umluft Kühlung
- Digitales Thermostat
- Automatische Abtauung
- Umgebungstemperatur +25°C

COLD DISPLAY

- LED lighting under each shelf and top
- Self-service through open front
- With night cover
- Fan cooling system
- Digital thermostat
- Automatic defrost
- Ambient temperature +25°C

VITRINE RÉFRIGÉRÉE

- Éclairage LED sous chaque étagère et dessus
- Libre-service grâce à la façade ouverte
- Avec couverture de nuit
- Système de refroidissement par ventilateur
- Thermostat digital
- Dégivrage automatique
- Temp. ambiente +25°C



WALL MOUNTED UNIT

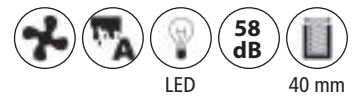

Cooking range

Drop-in

Ovens

Kitchen equipment

Refrigeration

Dishwashers

Neutral

Faucets

Ventilation

Pizzeria

Bakery

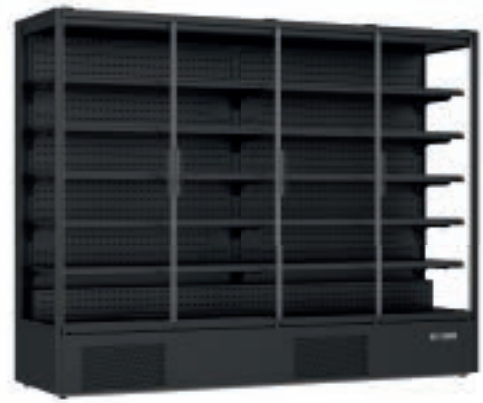

7455.3100

€ 4.195,-



7455.3105

€ 5.900,-



7455.3110

€ 6.995,-



MARCO

	1310x740x2010	1935x740x2010	2560x740x2010
	230 V / 0,55 kW	230 V / 0,98 kW	230V / 1,06 kW
	-1/+5°C	-1/+5°C	-1/+5°C
	R 290	R 290	R 290
	300	420	500

WANDKOELING

- LED verlichting onder elk schap
- 5 levels
- Isolatie 40 mm
- Omgevingstemp. +25°C
- Geforceerde koeling
- Automatische ontdooiing

WANDKÜHLUNG

- LED verlichting onder elk schap
- 5 Etagen
- Isolierschicht 40 mm
- Umgebungstemp. +25°C
- Umluft Kühlung
- Automatische Abtauung

WALL MOUNTED UNIT

- LED verlichting onder elk schap
- 5 levels
- Insulation 40 mm
- Ambient temp. +25°C
- Ventilated cooling
- Automatic defrost

CHAMBRE FROIDE MURALE

- LED verlichting onder elk schap
- 5 niveaux
- Isolation 40 mm
- Temp. ambiente +25°C
- Froid renforcé
- Dégivrage automatique



Refrigeration

COLD DISPLAY



LED



7350.0005 | 7350.0010 | 7350.0015



7350.0020 | 7350.0025 | 7350.0030

7350.0005	7350.0010	7350.0015	7350.0020	7350.0025	7350.0030
€ 5.300,-	€ 5.605,-	€ 6.495,-	€ 5.965,-	€ 6.285,-	€ 6.835,-

NOAH

	MET SCHUIFDEUREN MIT SCHIEBETÜREN WITH SLIDING DOORS AVEC PORTES COULISSANTES					
	1310 x 665 x 1500	1510 x 665 x 1500	1935 x 665 x 1500	1310 x 665 x 1500	1510 x 665 x 1500	1935 x 665 x 1500
	230 V / 1,8 kW	230 V / 1,8 kW	230 V / 2 kW	230 V / 1,8 kW	230 V / 1,8 kW	230 V / 2 kW
	2/4°C	2/4°C	2/4°C	2/4°C	2/4°C	2/4°C
	R 452 A	R 452 A	R 452 A	R 290	R 290	R 290
	210	270	340	210	270	340

KOELVITRINE

- LED verlichting
- Geventileerd koelsysteem
- 3 levels
- Automatische ontdooiing
- Omgevingstemperatuur +25°C

7350.0005-0010-0015:

- Zelfbediening middels open voorzijde
- Met nachtabdekking

KÜHLVITRINE

- LED Beleuchtung
- Umluft Kühlung
- 3 Etagen
- Automatische Abtauung
- Umgebungstemperatur +25°C

7350.0005-0010-0015:

- Selbstbedienung Vorderseite
- Mit Nachtabdeckung

COLD DISPLAY

- LED Lighting
- Fan cooling system
- 3 levels
- Automatic defrost
- Ambient temperature +25°C

7350.0005-0010-0015:

- Self-service through open front
- With night cover

VITRINE RÉFRIGÉRÉE

- Éclairage LED
- Système de refroidissement par ventilateur
- 3 niveaux
- Dégivrage automatique
- Temp. ambiente +25°C

7350.0005-0010-0015:

- En libre-service grâce à la façade ouverte
- Avec couverture de nuit

7350.9000 € 210,-

	Castors set
>	7350.0005-0010 7350.0020-0025

7350.9005 € 275,-

	Castors set
>	7350.0015-0030



WALL MOUNTED UNIT



LED



7350.0035 | 7350.0040 | 7350.0045



7350.0050 | 7350.0055 | 7350.0060

7350.0035	7350.0040	7350.0045	7350.0050	7350.0055	7350.0060
€ 5.485,-	€ 5.700,-	€ 6.515,-	€ 4.980,-	€ 5.230,-	€ 6.875,-

JAMIE

	2 DEUREN 2 TÜREN 2 DOORS 2 PORTES			3 DEUREN 3 TÜREN 3 DOORS 3 DES PORTES		
	1310 x 665 x 1920	1510 x 665 x 1920	1935 x 665 x 1920	1310 x 665 x 1920	1510 x 665 x 1920	1935 x 665 x 1920
	230 V / 1,52 kW	230 V / 1,52 kW	230 V / 2,3 kW	230 V / 1,52 kW	230 V / 1,52 kW	230 V / 2,3 kW
	2/4°C	2/4°C	2/4°C	2/4°C	2/4°C	2/4°C
	R 452 A	R 452 A	R 452 A	R 452 A	R 452 A	R 452 A
	280	305	380	280	305	380

WANDKOELING

- LED verlichting
- Geventileerd koelsysteem
- 4 levels
- Automatische ontdooiing
- Omgevingstemperatuur +25°C

7350.0035-0040-0045:

- Zelfbediening middels open voorzijde
- Met nachtafdekking

WANDKÜHLUNG

- LED Beleuchtung
- Umluft Kühlung
- 4 Etagen
- Automatische Abtauung
- Umgebungstemperatur +25°C

7350.0035-0040-0045:

- Selbstbedienung Vorderseite
- Mit Nachtabdeckung

WALL MOUNTED UNIT

- LED Lighting
- Fan cooling system
- 4 levels
- Automatic defrost
- Ambient temperature +25°C

7350.0035-0040-0045:

- Self-service through open front
- With night cover

CHAMBRE FROIDE MURALE

- Éclairage LED
- Système de refroidissement par ventilateur
- 4 niveaux
- Dégivrage automatique
- Temp. ambiente +25°C

7350.0035-0040-0045:

- En libre-service grâce à la façade ouverte
- Avec couverture de nuit

Cooking range

Drop-in

Ovens

Kitchen equipment

Refrigeration

Dishwashers

Neutral

Faucets

Ventilation

Pizzeria

Bakery



Refrigeration

WALL MOUNTED UNIT



LED



7350.0065

€ 7.545,-



7350.0070

€ 9.850,-



7350.0075 (*)

€ 12.375,-



7350.0080 (*)

€ 25.535,-



MIKE

	1350 x 865 x 2000	1935 x 865 x 2000	2560 x 865 x 2000	3810 x 865 x 2000
	230 V / 0,37 kW	230 V / 0,44 kW	230 V / 0,71 kW	230 V / 0,74 kW
	-1/5°C	-1/5°C	-1/5°C	-1/5°C
	R 290	R 290	R 290	R 290
	370	490	630	960

(*) EXPORT TRANSPORTKOSTEN OP AANVRAAG | TRANSPORTKOSTEN AUF ANFRAGE | TRANSPORT COSTS ON REQUEST | FRAIS DE TRANSPORT SUR DEMANDE

WANDKOELING

- LED verlichting onder elk schap en aan de bovenkant
- Zelfbediening middels open voorzijde
- Met nachtafdekking
- Geventileerd koelsysteem
- Digitale thermostaat
- Automatische ontdooiing
- Omgevingstemperatuur +25°C

WANDKÜHLUNG

- LED Beleuchtung unten jede Regal und an der Oberseite
- Selbstbedienung Vorderseite
- Mit Nachtabdeckung
- Umluft Kühlung
- Digitales Thermostat
- Automatische Abtauung
- Umgebungstemperatur +25°C

WALL MOUNTED UNIT

- LED lighting under each shelf and top
- Self-service through open front
- With night cover
- Fan cooling system
- Digital thermostat
- Automatic defrost
- Ambient temperature +25°C

CHAMBRE FROIDE MURALE

- Éclairage LED sous chaque étagère et vers le haut
- En libre-service grâce à la façade ouverte
- Avec couverture de nuit
- Système de refroidissement par ventilateur
- Thermostat digital
- Dégivrage automatique
- Temp. ambiente +25°C



WALL MOUNTED UNIT - REMOTE



LED

Cooking range

Drop-in

Ovens

Kitchen equipment

Refrigeration

Dishwashers

Neutral

Faucets

Ventilation

Pizzeria

Bakery

7350.0085

€ 7.615,-



7350.0090 (*)

€ 8.765,-



7350.0095(*)

€ 12.725,-



JAX

	2035 x 850 x 2050	2660 x 850 x 2050	3910 x 850 x 2050
	230 V / 0,11 kW	230 V / 0,13 kW	230 V / 0,185 kW
	2/4°C	2/4°C	2/4°C
	345	455	685

(*) EXPORT TRANSPORTKOSTEN OP AANVRAAG | TRANSPORTKOSTEN AUF ANFRAGE | TRANSPORT COSTS ON REQUEST | FRAIS DE TRANSPORT SUR DEMANDE



7492.0210

€ 4.600,-



7492.0215

€ 4.290,-



7492.0220

€ 4.590,-



KOELMOTOR | KONDENSATOR EINHEIT | CONDENSING UNIT | L'UNITÉ DE CONDENSATION

>	7350.0085	7350.0090	7350.0095
	1097 x 440 x 542	1097 x 440 x 542	1097 x 440 x 542
	230 V / 0,86 kW	230 V / 1,08 kW	230 V / 1,94 kW
	-5/-10°C	-5/-10°C	-5/-10°C
	R 452 A	R 452 A	R 452 A
	75	85	86

WANDKOELING - REMOTE

- LED verlichting onder elk schap en aan de bovenkant
- Zelfbediening middels open voorzijde
- Met nachtabdekking
- Geventileerd koelsysteem
- Digitale thermostaat
- Automatische ontdooing
- Omgevingstemperatuur +25°C

WANDKÜHLUNG - REMOTE

- LED Beleuchtung unten jede Regal und an der Oberseite
- Selbstbedienung Vorderseite
- Mit Nachtabdeckung
- Umluft Kühlung
- Digitales Thermostat
- Automatische Abtauung
- Umgebungstemperatur +25°C

WALL MOUNTED UNIT - REMOTE

- LED lighting under each shelf and top
- Self-service through open front
- With night cover
- Fan cooling system
- Digital thermostat
- Automatic defrost
- Ambient temperature +25°C

CHAMBRE FROIDE MURALE - REMOTE

- Éclairage LED sous chaque étagère et vers le haut
- En libre-service grâce à la façade ouverte
- Avec couverture de nuit
- Système de refroidissement par ventilateur
- Thermostat digital
- Dégivrage automatique
- Temp. ambiente +25°C



Refrigeration

Refrigerators & Freezer Cabinets

Refrigerated & Freezer Counters

Saladettes

Coldrooms

Chest Freezers

Display Refrigeration

Ice Machines

WINE COOLER

WIJNKOELKAST

WEINKÜHLSCHRANKE

WINE COOLER

RAFRAÎCHISSEURS À VIN



LED



7525.0005



7525.0010



7525.0015



7525.0020



7525.0025



7525.0030



7525.0035



7525.0040

7525.0005	7525.0010	7525.0015	7525.0020	7525.0025	7525.0030	7525.0035	7525.0040
€ 1.092,-	€ 1.194,-	€ 691,-	€ 850,-	€ 799,-	€ 1.245,-	€ 2.390,-	€ 2.202,-
SINGLE ZONE	DUAL ZONE	SINGLE ZONE	SINGLE ZONE BUILT-IN	SINGLE ZONE	DUAL ZONE	DUAL ZONE	SINGLE ZONE

	595x570x820	595x570x820	295x570x820	592x555x455	485x600x820	595x570x820	595x710x1720	595x570x1780
	230 V 0,16 kW	230 V 0,16 kW	230 V 0,08kW	230 V 0,08 kW	230 V 0,11 kW	230 V 0,18 kW	230 V 0,18 kW	230 V 0,18 kW
	127 L	119 L	50 L	51 L	118 L	100 L	379 L	325 L
	+5/+20°C	+5/+20°C	+5/+20°C	+5/+20°C	+5/+20°C	+5/+20°C	+5/+20°C	+5/+20°C
	R 600 A	R 600 A	R 600 A	R 600 A	R 600 A	R 600 A	R 600 A	R 600 A
	5x	4x	5x	3x	5x	2x 5	13x	14x
	46x	39x	20x	24x	49x	40x	154x	115x
dB	39	40	40	42	40	40x	43	40
	40 mm	40 mm	40 mm	40 mm	40 mm	40 mm	55 mm	55 mm
	45	47	29	27	40	47	99	91



WINE COOLER



Cooking range

Drop-in

Ovens

Kitchen equipment

Refrigeration

Dishwashers

Neutral

Faucets

Ventilation

Pizzeria

Bakery

7455.1900

€ 1.085,-



DUAL ZONE

7455.1905

€ 1.220,-



DUAL ZONE

7455.1910

€ 1.805,-



DUAL ZONE

	655 x 380 x 860	655 x 595 x 860	735 x 595 x 1411
	230 V 0,4 kW	230 V 0,41 kW	230 V 0,45 kW
	88 L	165 L	330 L
	+4/+20°C	+4/+20°C	+4/+20°C
	R 600 A	R 600 A	R 600 A
	5x	5x	11x
	22/27x	43/44x	111x
	40	60	90

WIJNKOELKAST

- Isolatie 50mm
- Omgevingstemp. +43°C
- Vast ingebouwde compressor
- Houten roosters
- Dual zone
- De max. capaciteit wijnflessen is gebaseerd op standaard 750ml Bordeauxflessen

WEINKÜHLSCHRÄNKE

- Isolierschicht 50mm
- Umgebungstemp. +43°C
- Fest installierte Kompressor
- Holzern roste
- Dual mode
- Die Maximale Kapazität von Weinflaschen ist berechnet mit Standard 750ML Bordeaux Flaschen.

WINE COOLER

- Insulation 50mm
- Ambient temp. +43°C
- Permanently installed compressor
- Wooden shelves
- Dual mode
- The max. capacity of wine bottles is based on standard 750ml Bordeaux bottles.

RAFRAÎCHISSEURS À VIN

- Isolation 50mm
- Temp. ambiente +43°C
- Compresseur fixé
- Grilles a bois
- Dual mode
- La capacité maximale des bouteilles de vin est basée sur la capacité des bouteilles bordelaises standard de 750ml.



Refrigeration

PASS-THROUGH WINE COOLER



Refrigerators & Freezer Cabinets

Refrigerated & Freezer Counters

Saladettes

Coldrooms

Chest Freezers

Display Refrigeration

Ice Machines

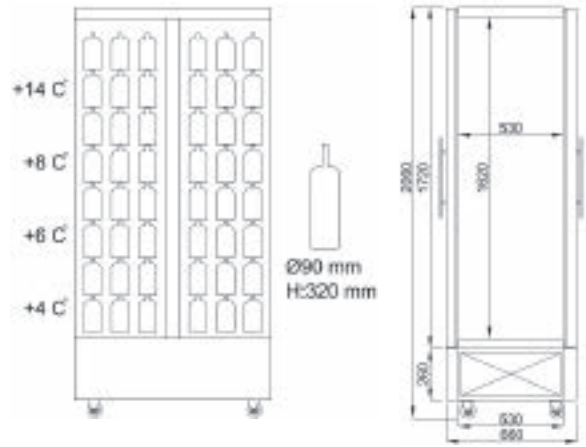
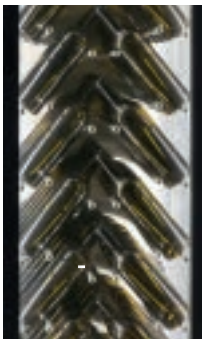

7489.5415

€ 8.385,-



	1000 x 660 x 2060
	230 V / 0,6 kW
	112 L
	+4/+14°C
	R 290
	112
	195

DOORGEEF WIJNKOELKAST

- Isolatie 40 mm
- Omgevingstemp. +30°C
- Vast ingebouwde compressor
- 4 deuren

WEINKÜHLCHRÄNKE DURCHREICHE

- Isolierschicht 40 mm
- Umgebungstemp. +30°C
- Fest installierte Kompressor
- 4 Türen

PASS-THROUGH WINE COOLER

- Insulation 40 mm
- Ambient temp. +30°C
- Permanently installed compressor
- 4 doors

RAFRAÎCHISSEURS À VIN DOUBLE FACADE

- Isolation 40 mm
- Temp. ambiente +30°C
- Compresseur fixé
- 4 portes



WINE COOLER

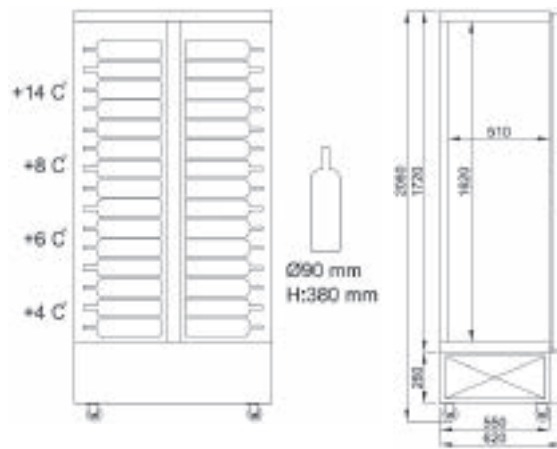

Cooking range

Drop-in

Ovens

Kitchen equipment

Refrigeration

Dishwashers

Neutral

Faucets

Ventilation

Pizzeria

Bakery

7489.5420

€ 7.385,-



	1000 x 660 x 2060
	230 V / 0,6 kW
	120 L
	+4/+14°C
	R 290
	120
	190

WIJNKOELKAST

- Isolatie 40 mm
- Omgevingstemp. +30°C
- Vast ingebouwde compressor

WEINKÜLSCHRÄNKE

- Isolierschicht 40 mm
- Umgebungstemp. +30°C
- Fest installierte Kompressor

WINE COOLER

- Insulation 40 mm
- Ambient temp. +30°C
- Permanently installed compressor

RAFRAÎCHISSEURS À VIN

- Isolation 40 mm
- Temp. ambiente +30°C
- Compresseur fixé



Refrigeration

BACKBAR COOLER



LED 45 mm



Refrigerators & Freezer Cabinets

Refrigerated & Freezer Counters

Saladettes

Coldrooms

Chest Freezers

Display Refrigeration

Ice Machines

	7526.0300	7526.0305	7455.1360
	€ 1.195,-	€ 1.595,-	€ 1.925,-
	600 x 515 x 1820	900 x 515 x 1820	900 x 515 x 1820
	230 V / 0,28 kW	230 V / 0,38 kW	230 V / 0,38 kW
	293 L	458 L	458 L
	+2/+10°C	+2/+10°C	+2/+10°C
	R 600 A	R 600 A	R 600 A
	75	100	105

BARKOELER

- Isolatie 45 mm
- Vast ingebouwde compressor
- Incl. 5 roosters en geleidersets per deur
- Cap. 42 geleiders per deur
- Ruimte tussen geleiders 20 mm

BARKÜHLER

- Isolierschicht 45 mm
- Fest installierte Kompressor
- Einschließlich 5 Gitter mit Führungsschiene hinter jeden Tür
- Für maximal 42 Führungsschienen
- Abstand zwischen Führungsschienen 20 mm

BACKBAR COOLER

- Insulation 45 mm
- Permanently installed compressor
- Incl. 5 grids and set guides per door
- Cap. 42 guides per door
- Space between guides 20 mm

RÉFRIGÉRATEUR DE BAR

- Isolation 45 mm
- Compresseur fixé
- 5 Grilles et Glissières par porte inclus
- Cap. 42 Glissières par porte
- Espace entre les Glissières 20 mm

7526.9300		€ 19,-
	Grids	
>	7526.0300	

7526.9305		€ 19,-
	Grids left	
>	7526.0305	

7526.9310		€ 19,-
	Grids right	
>	7526.0305	

7526.9000		€ 5,-
	Set clips for grid (4x)	
>	7526.0300-0305	

7455.1351		€ 31,-
	Grids left	
>	7455.1360	

7455.1354		€ 23,-
	Grids right	
>	7455.1360	

7455.1352		€ 8,-
	Set clips for grid (4x)	
>	7455.1360	



BACKBAR COOLER FULL GLASS DOORS



Cooking range

Drop-in

Ovens

Kitchen equipment

Refrigeration

Dishwashers

Neutral

Faucets

Ventilation

Pizzeria

Bakery

7455.1347

€ 1.395,-



7455.1353

€ 1.895,-



	600 x 515 x 1820	900 x 515 x 1820
	230 V / 0,28 kW	230 V / 0,38 kW
	293 L	458 L
	+2/+10°C	+2/+10°C
	R 600 A	R 600 A
	75	100

BARKOELER VOLLEDIGE GLASDEUREN

- Isolatie 45 mm
- Vast ingebouwde compressor
- Incl. 5 roosters en geleidersets per deur
- Cap. 42 geleiders per deur
- Ruimte tussen geleiders 20 mm

BARKÜHLER KOMPLETTE GLASTÜREN

- Isolierschicht 45 mm
- Fest installierte Kompressor
- Einschließlich 5 Gitter mit Führungsschiene hinter jeden Tür
- Für maximal 42 Führungsschienen
- Abstand zwischen Führungsschienen 20 mm

BACKBAR COOLER FULL GLASS DOORS

- Insulation 45 mm
- Permanently installed compressor
- Incl. 5 grids and set guides per door
- Cap. 42 guides per door
- Space between guides 20 mm

RÉFRIGÉRATEUR DE BAR AVEC PORTES VITRÉE

- Isolation 45 mm
- Compresseur fixé
- 5 Grilles et Glissières par porte inclus
- Cap. 42 Glissières par porte
- Espace entre les Glissières 20 mm

7455.1346 € 23,-

	Grids
>	7455.1347

7455.1351 € 31,-

	Grids left
>	7455.1353

7455.1354 € 23,-

	Grids right
>	7455.1353

7455.1352 € 8,-

	Set clips for grid (4x)
--	-------------------------



Refrigeration

BACKBAR COOLER BLACK



Refrigerators & Freezer Cabinets

Refrigerated & Freezer Counters

Saladettes

Coldrooms

Chest Freezers

Display Refrigeration

Ice Machines



	7455.1315	7455.1320	7455.1300	7455.1305	7455.1310
	€ 890,-	€ 1.140,-	€ 615,-	€ 820,-	€ 1.050,-
	SLIDING DOORS	SLIDING DOORS			
	900 x 500 x 900	1335 x 500 x 900	500 x 500 x 900	900 x 500 x 900	1335 x 500 x 900
	230 V / 0,24 kW	230 V / 0,3 kW	230 V / 0,18 kW	230 V / 0,24 kW	230 V / 0,3 kW
	198 L	298 L	98 L	198 L	298 L
	0/+10°C	0/+10°C	+2/+10°C	+2/+10°C	+2/+10°C
	R 600 A	R 600 A	R 600 A	R 600 A	R 600 A
	X	X	✓	✓	✓
	55	80	35	55	80

BARKOELER ZWART

- Isolatie 45 mm
- Vast ingebouwde compressor
- Incl. 2 roosters en geleidersets per deur
- Cap. 17 geleiders per deur
- Ruimte tussen geleiders 20 mm

BARKÜHLER SCHWARZ

- Isolierschicht 45 mm
- Fest installierte Kompressor
- Einschließlich 2 Gitter mit Führungsschiene
- Für maximal 17 Führungsschienen
- Abstand zwischen Führungsschienen 20 mm

BACKBAR COOLER BLACK

- Insulation 45 mm
- Permanently installed compressor
- Incl. 2 grids and set guides per door
- Cap. 17 guides per door
- Space between guides 20 mm

ARRIÈRE BAR RÉFRIGÉRÉE NOIR

- Isolation 45 mm
- Compresseur fixé
- 2 Grilles et Glissières par porte inclus
- Cap. 17 Glissières par porte
- Espace entre les Glissières 20 mm

7455.1302		€ 20,-
	Grids	
>	7455.1300 7455.1305 7455.1310	

7455.1304		€ 25,-
	Grids L/R	
>	7455.1315-1320	

7455.1303		€ 20,-
	Grids Middle	
>	7455.1320	

7455.1306		€ 6,-
	Set clips for grid (4x)	



BACKBAR COOLER BLACK FULL GLASS DOORS

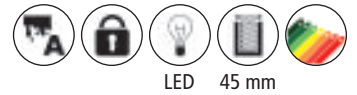

LED 45 mm



7455.1301

7455.1307

€ 715,-

€ 1.125,-

	500 x 500 x 840	900 x 500 x 840
	230 V / 0,18 kW	230 V / 0,24 kW
	98 L	198 L
	+2/+10°C	+2/+10°C
	R 600 A	R 600 A
	35	55

BARKOELER ZWART VOLLEDIGE GLASDEUREN

- Isolatie 45 mm
- Vast ingebouwde compressor
- Incl. 2 roosters en geleidersets per deur
- Cap. 17 geleiders per deur
- Ruimte tussen geleiders 20 mm

BARKÜHLER SCHWARZ KOMPLETTE GLASTÜREN

- Isolierschicht 45 mm
- Fest installierte Kompressor
- Einschließlich 2 Gitter mit Führungsschiene
- Für maximal 17 Führungsschienen
- Abstand zwischen Führungsschienen 20 mm

BACKBAR COOLER BLACK FULL GLASS DOORS

- Insulation 45 mm
- Permanently installed compressor
- Incl. 2 grids and set guides per door
- Cap. 17 guides per door
- Space between guides 20 mm

ARRIÈRE BAR RÉFRIGÉRÉE NOIR AVEC PORTES VITRÉE

- Isolation 45 mm
- Compresseur fixé
- 2 Grilles et Glissières par porte inclus
- Cap. 17 Glissières par porte
- Espace entre les Glissières 20 mm

7455.1302 € 20,-



Grids

7455.1306 € 6,-



Set clips for grid (4x)



Refrigeration

BACKBAR COOLER BLACK



LED 40 mm



	7527.0020	7527.0025	7527.0005	7527.0010	7527.0015
	€ 865,-	€ 1.080,-	€ 660,-	€ 830,-	€ 1.020,-
	SLIDING DOORS	SLIDING DOORS			
	900 x 520 x 900	1350 x 520 x 900	600 x 520 x 900	900 x 520 x 900	1350 x 520 x 900
	820 x 385 x 750	1260 x 385 x 750	520 x 385 x 750	820 x 385 x 750	1260 x 385 x 750
	230 V / 0,23 kW	230 V / 0,265 kW	230 V / 0,18 kW	230 V / 0,23 kW	230 V / 0,265 kW
	208 L	330 L	138 L	208 L	330 L
	0/+10°C	0/+10°C	0/+10°C	0/+10°C	0/+10°C
	R 600 A	R 600 A	R 600 A	R 600 A	R 600 A
	X	X	✓	✓	✓
	72	90	58	72	90

BARKOELER ZWART

- Isolatie 40mm
- Omgevingstemp. +38°C
- Vast ingebouwde compressor
- Incl. 2 roosters en geleidersets per deur
- Behuizing zwart gepoedercoat

BARKÜHLER SCHWARZ

- Isolierschicht 40mm
- Umgebungstemp. +38°C
- Fest installierte Kompressor
- Einschließlich 2 Gitter mit Führungsschiene
- Gehäuse Schwarz pulverbeschichtet

BACKBAR COOLER BLACK

- Insulation 40mm
- Ambient temp. +38°C
- Permanently installed compressor
- Incl. 2 grids and set guides per door
- Housing black powdercoated

ARRIÈRE BAR RÉFRIGÉRÉE NOIR

- Isolation 40mm
- Temp. ambiente +38°C
- Compresseur fixé
- 2 Grilles et Glissières par porte inclus
- Revêtement en poudre noir



BACKBAR COOLER BLACK



LED 40 mm



HEIGHT
850

	7527.0045	7527.0050	7527.0030	7527.0035	7527.0040
	€ 820,-	€ 1.020,-	€ 615,-	€ 785,-	€ 960,-
	SLIDING DOORS	SLIDING DOORS			
	900 x 520 x 850	1350 x 520 x 850	600 x 520 x 850	900 x 520 x 850	1350 x 520 x 850
	820 x 385 x 700	1260 x 385 x 700	520 x 385 x 700	820 x 385 x 700	1260 x 385 x 700
	230 V / 0,23 kW	230 V / 0,265 kW	230 V / 0,18 kW	230 V / 0,23 kW	230 V / 0,265 kW
	198 L	320 L	128 L	198 L	320 L
	0/+10°C	0/+10°C	0/+10°C	0/+10°C	0/+10°C
	R 600 A	R 600 A	R 600 A	R 600 A	R 600 A
	X	X	✓	✓	✓
	72	90	58	72	90

BARKOELER ZWART

- Isolatie 40 mm
- Omgevingstemp. +38°C
- Vast ingebouwde compressor
- Incl. 2 roosters en geleidersets per deur
- Behuizing zwart gepoedercoat

BARKÜHLER SCHWARZ

- Isolierschicht 40 mm
- Umgebungstemp. +38°C
- Fest installierte Kompressor
- Einschließlich 2 Gitter mit Führungsschiene
- Gehäuse Schwarz pulverbeschichtet

BACKBAR COOLER BLACK

- Insulation 40 mm
- Ambient temp. +38°C
- Permanently installed compressor
- Incl. 2 grids and set guides per door
- Housing black powdercoated

ARRIÈRE BAR RÉFRIGÉRÉE NOIR

- Isolation 40 mm
- Temp. ambiente +38°C
- Compresseur fixé
- 2 Grilles et Glissières par porte inclus
- Revêtement en poudre noir

Cooking range

Drop-in

Ovens

Kitchen equipment

Refrigeration

Dishwashers

Neutral

Faucets

Ventilation

Pizzeria

Bakery



Refrigeration

BEER COUNTER



Refrigerators & Freezer Cabinets

Refrigerated & Freezer Counters

Saladettes

Coldrooms

Chest Freezers

Display Refrigeration

Ice Machines

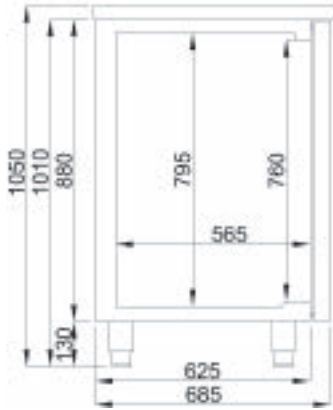

	7489.5310	7489.5315	7489.5320	7489.5325
	€ 3.455,-	€ 3.455,-	€ 3.920,-	€ 3.920,-
	2 DOORS	2 DOORS	2 DOORS	2 DOORS
	1550 x 700 x 950	1550 x 700 x 950	1950 x 700 x 950	1950 x 700 x 950
	1x 300 x 500	1x 300 x 500	2x 300 x 500	2x 300 x 500
	230 V / 0,36 kW	230 V / 0,36 kW	230 V / 0,36 kW	230 V / 0,36 kW
	+2 / +8°C	+2 / +8°C	+2 / +8°C	+2 / +8°C
	R 290	R 290	R 290	R 290
	2x	2x	2x	2x
	200	200	225	225

BIERKOELER

- Afm. roosters 540x405mm
- Ruimte voor 1 biervat per deur als je de roosters eruit haalt
- Omgevingstemperatuur 43°C
- Inclusief lekblad
- Afmeting spoelbak 300x500mm
- Digitale thermostaat
- Tapkraan op aanvraag

BIERTHEKE

- Abmessungen Gitter 540x405mm
- Bietet ausreichend Platz für 1 Bierfass pro Tür, wenn Sie die Gitter herausnehmen
- Umgebungstemperatur 43°C
- Inkl. Tropfschale
- Abmessung Waschbecken 300x500mm
- Digitales Thermostat
- Bier Zapfen auf Anfrage

BEER COUNTER

- Dimensions shelves 540x405mm
- Space for 1 beer keg per door when you take out the shelves
- Ambient temperature 43°C
- Including drip tray
- Dimensions sink 300x500mm
- Digital thermostat
- Beer Tower on request

REFROIDISSEUR DE BIÈRE

- Dimensions étagère 540x405mm
- Espace pour 1 fût de bière par porte si vous retirez les grilles
- Température ambiante 43°C
- Egouttoir compris
- Dimensions évier 300x500mm
- Thermostat numérique
- Robinetterie sur demande

7489.0560 € 40,-



Grids

7489.0555 € 455,-



Drawers



BEER COUNTER

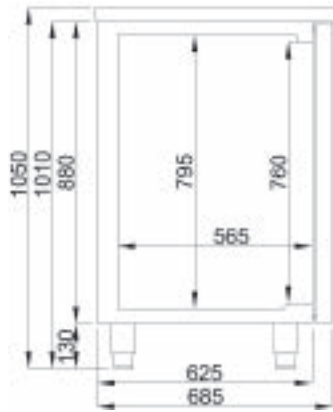

Cooking range

Drop-in

Ovens

Kitchen equipment

Refrigeration

Dishwashers

Neutral

Faucets

Ventilation

Pizzeria

Bakery

	7489.5330	7489.5335	7489.5340	7489.5345
	€ 3.635,-	€ 3.635,-	€ 4.425,-	€ 4.425,-
	3 DOORS	3 DOORS	3 DOORS	3 DOORS
	2100 x 700 x 950	2100 x 700 x 950	2500 x 700 x 950	2500 x 700 x 950
	1x 300 x 500	1x 300 x 500	2x 300 x 500	2x 300 x 500
	230 V / 0,36 kW	230 V / 0,36 kW	230 V / 0,36 kW	230 V / 0,36 kW
	+2 / +8°C	+2 / +8°C	+2 / +8°C	+2 / +8°C
	R 290	R 290	R 290	R 290
	3x	3x	3x	3x
	251	251	287	287

BIERKOELER

- Afm. roosters 540x405mm
- Ruimte voor 1 biervat per deur als je de roosters eruit haalt
- Omgevingstemperatuur 43°C
- Inclusief lekblad
- Afmeting spoelbak 300x500mm
- Digitale thermostaat
- Tapkraan op aanvraag

BIERTHEKE

- Abmessungen Gitter 540x405mm
- Bietet ausreichend Platz für 1 Bierfass pro Tür, wenn Sie die Gitter herausnehmen
- Umgebungstemperatur 43°C
- Inkl. Tropfschale
- Abmessung Waschbecken 300x500mm
- Digitales Thermostat
- Bier Zapfen auf Anfrage

BEER COUNTER

- Dimensions shelves 540x405mm
- Space for 1 beer keg per door when you take out the shelves
- Ambient temperature 43°C
- Including drip tray
- Dimensions sink 300x500mm
- Digital thermostat
- Beer Tower on request

REFROIDISSEUR DE BIÈRE

- Dimensions étagère 540x405mm
- Espace pour 1 fût de bière par porte si vous retirez les grilles
- Température ambiante 43°C
- Egouttoir compris
- Dimensions évier 300x500mm
- Thermostat numérique
- Robinetterie sur demande



Refrigeration

STANDARD LINE

BACKBAR COOLER



50 dB



LED 40 mm

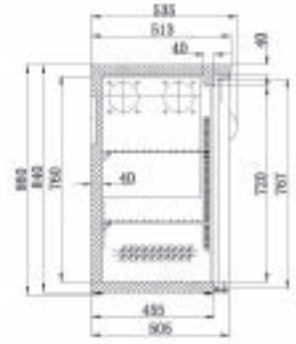

7450.0315

7450.0320

7450.0325 *

€ 1.735,-

€ 1.950,-

€ 2.485,-

	1462 x 513 x 860	2002 x 513 x 860	2542 x 513 x 860
	1082 x 415 x 760	1618 x 415 x 760	2162 x 415 x 760
	230 V / 0,28 kW	230 V / 0,28 kW	230 V / 0,44 kW
	350 L	537 L	698 L
	0/+10°C	0/+10°C	0/+10°C
	R 600 A	R 600 A	R 600 A
	100	125	150

(*) EXPORT FRAIS DE TRANSPORT SUR DEMANDE

BARCOOLER ZWART

- Isolatie 40 mm
- Omgevingstemp. +32°C
- Vast ingebouwde compressor
- Incl. 2 roosters 1/1GN en geleidersets per deur
- Cap. 22 geleiders per deur
- Ruimte tussen geleiders 25 mm

BARKÜHLER SCHWARZ

- Isolierschicht 40 mm
- Umgebungstemp. +32°C
- Fest installierte Kompressor
- Einschließlich 2 Gitter 1/1GN mit Führungsschiene
- Für maximal 22 Führungsschienen
- Abstand zwischen Führungsschienen 25 mm

BARCOOLER BLACK

- Insulation 40 mm
- Ambient temp. +32°C
- Permanently installed compressor
- Incl. 2 grids 1/1GN and set guides per door
- Cap. 22 guides per door
- Space between guides 25 mm

ARRIÈRE BAR RÉFRIGÉRÉE NOIR

- Isolation 40 mm
- Temp. ambiente +32°C
- Compresseur fixé
- 2 Grilles 1/1GN et Glissières par porte inclus
- Cap. 22 Glissières par porte
- Espace entre les Glissières 25 mm

7450.0330 € 650,-



Drawers



BARCOOLER BLACK



Cooking range

Drop-in

Ovens

Kitchen equipment

	7489.5270	7489.5275	7489.5280 *
	€ 2.455,-	€ 2.830,-	€ 3.205,-
	1380 x 550 x 950	1940 x 550 x 950	2490 x 550 x 950
	230 V / 0,36 kW	230 V / 0,46 kW	230 V / 0,56 kW
	320 L	500 L	680 L
	-2/+8°C	-2/+8°C	-2/+8°C
	R 290	R 290	R 290
	150	160	180

Refrigeration

Dishwashers

Neutral

(*) EXPORT FRAIS DE TRANSPORT SUR DEMANDE

BARKOELER ZWART

- Isolatie 60 mm
- Omgevingstemp. +32°C
- Vast ingebouwde compressor
- Incl. 2 roosters 1/1GN en geleidersets per deur

BARKÜHLER SCHWARZ

- Isolierschicht 60 mm
- Umgebungstemp. +32°C
- Fest installierte Kompressor
- Einschließlich 2 Gitter 1/1GN mit Führungsschiene

BACKBAR COOLER BLACK

- Insulation 60 mm
- Ambient temp. +32°C
- Permanently installed compressor
- Incl. 2 grids 1/1GN and set guides per door

ARRIÈRE BAR RÉFRIGÉRÉE NOIR

- Isolation 60 mm
- Temp. ambiente +32°C
- Compresseur fixé
- 2 Grilles 1/1GN et Glissières par porte inclus

Faucets

Ventilation

Pizzeria

7489.0544 € 100,-

Grids

7489.0910 € 100,-

Castors set (6x)

> 7489.5280

ON REQUEST

60Hz ON REQUEST

Bakery



BARCOOLER BLACK GLASS DOORS



LED 40 mm

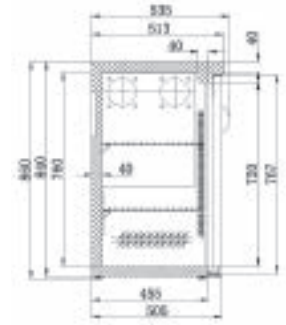

7450.0335

€ 1.835,-

7450.0340

€ 2.125,-

7450.0345 *

€ 2.635,-

	1462 x 535 x 860	2002 x 535 x 860	2542 x 535 x 860
	1082 x 415 x 760	1618 x 415 x 760	2162 x 415 x 760
	230 V / 0,28 kW	230 V / 0,28kW W	230 V / 0,44 kW
	350 L	537 L	698 L
	+2/+8°C	+2/+8°C	+2/+8°C
	R 290	R 290	R 290
	121	154	171

(*) EXPORT FRAIS DE TRANSPORT SUR DEMANDE

BARKOELER ZWART GLASDEUREN

- Isolatie 40 mm
- Omgevingstemp. +32°C
- Vast ingebouwde compressor
- Incl. 2 roosters 1/1GN en geleidersets per deur
- Cap. 22 geleiders per deur
- Ruimte tussen geleiders 25 mm

BARKÜHLER SCHWARZ GLASTÜREN

- Isolierschicht 40 mm
- Umgebungstemp. +32°C
- Fest installierte Kompressor
- Einschließlich 2 Gitter 1/1GN mit Führungsschiene
- Für maximal 22 Führungsschienen
- Abstand zwischen Führungsschienen 25 mm

BARCOOLER BLACK GLASS DOORS

- Insulation 40 mm
- Ambient temp. +32°C
- Permanently installed compressor
- Incl. 2 grids 1/1GN and set guides per door
- Cap. 22 guides per door
- Space between guides 25 mm

ARRIÈRE BAR RÉFRIGÉRÉE NOIR PORTES EN VERRE

- Isolation 40 mm
- Temp. ambiente +32°C
- Compresseur fixé
- 2 Grilles 1/1GN et Glissières par porte inclus
- Cap. 22 Glissières par porte
- Espace entre les Glissières 25 mm



BARCOOLER BLACK GLASS DOORS



60 mm



Cooking range

Drop-in

Ovens

Kitchen equipment

	7489.5285	7489.5290	7489.5295 *
	€ 2.640,-	€ 3.125,-	€ 3.625,-
	1380 x 550 x 950	1940 x 550 x 950	2490 x 550 x 950
	230 V / 0,36 kW	230 V / 0,46 kW	230 V / 0,56 kW
	320 L	500 L	680 L
	-2/+8°C	-2/+8°C	-2/+8°C
	R 290	R 290	R 290
	150	160	180

(*) EXPORT FRAIS DE TRANSPORT SUR DEMANDE

Refrigeration

Dishwashers

Neutral

BARKOELER ZWART GLASDEUREN

- Isolatie 60 mm
- Omgevingstemp. +32°C
- Vast ingebouwde compressor
- Incl. 2 roosters 1/1GN en geleidersets per deur

BARKÜHLER SCHWARZ GLASTÜREN

- Isolierschicht 60 mm
- Umgebungstemp. +32°C
- Fest installierte Kompressor
- Einschließlich 2 Gitter 1/1GN mit Führungsschiene

BARCOOLER BLACK GLASS DOORS

- Insulation 60 mm
- Ambient temp. +32°C
- Permanently installed compressor
- Incl. 2 grids 1/1GN and set guides per door

ARRIÈRE BAR RÉFRIGÉRÉE NOIR PORTES EN VERRE

- Isolation 60 mm
- Temp. ambiente +32°C
- Compresseur fixé
- 2 Grilles 1/1GN et Glissières par porte inclus

Faucets

Ventilation

Pizzeria

7489.0544 € 100,-

Grids

7489.0910 € 100,-

Castors set (6x)

> 7489.5280

ON REQUEST

60Hz ON REQUEST

Bakery



Refrigeration

STANDARD LINE

REFRIGERATED COUNTER

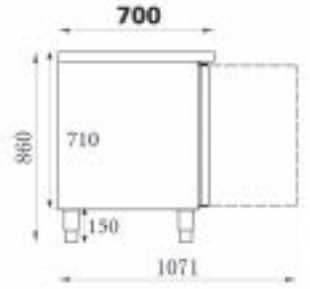

Refrigerators & Freezer Cabinets

Refrigerated & Freezer Counters

Saladettes

Coldrooms

Chest Freezers

Display Refrigeration

Ice Machines



	7950.0080	7950.0082	7950.0084
	€ 1.435,-	€ 1.700,-	€ 2.045,-
	1360 x 700 x 850	1795 x 700 x 850	2230 x 700 x 850
	795 x 580 x 560	1230 x 580 x 560	1665 x 580 x 560
	230 V / 0,34 kW	230 V / 0,34 kW	230 V / 0,34 kW
	282 L	417 L	553 L
	+2/+8°C	+2/+8°C	+2/+8°C
	R 600 A	R 600 A	R 600 A
	115	160	190

KOELWERKBANK

- Isolatie 60mm
- Omgevingstemp. +38°C
- Vast ingebouwde compressor
- Incl. 1 rooster 1/GN en geleiderset per deur
- Cap. 12 geleiders per deur
- Ruimte tussen geleiders 40mm

KÜHLTISCH

- Isolierschicht 60mm
- Umgebungstemp. +38°C
- Fest installierte Kompressor
- Einschließlich 1 Gitter 1/1GN mit Führungsschiene hinter jeden Tür
- Für maximal 12 Führungsschienen
- Abstand zwischen Führungsschienen 40mm

REFRIGERATED COUNTER

- Insulation 60mm
- Ambient temp. +38°C
- Permanently installed compressor
- Incl. 1 grids 1/1GN and set guides per door
- Cap. 12 guides per door
- Space between guides 40mm

TABLE RÉFRIGÉRÉE

- Isolation 60mm
- Temp. ambiente +38°C
- Compresseur fixé
- 1 Grilles 1/1GN et Glissières par porte inclus
- Cap. 12 Glissières par porte
- Espace entre les Glissières 40mm

7450.0505 **€ 27,-**

	Grids PE COATED
GN	1/1 GN

7020.1200 **€ 30,-**

	Grids SS
GN	1/1 GN

7451.0010 **€ 83,-**

	Castors set (4x)
--	------------------

7451.0009 **€ 121,-**

	Castors set (6x)
--	------------------

7451.0005 **€ 690,-**

	Drawers
--	---------

7950.5048 **€ 45,-**

	Set guides
--	------------



REFRIGERATED COUNTER

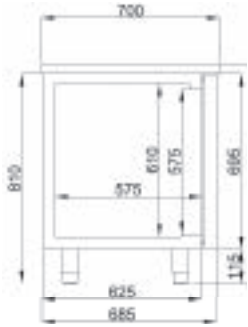
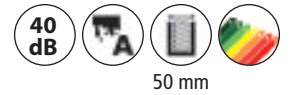

Cooking range

Drop-in

Ovens

Kitchen equipment

Refrigeration

Dishwashers

Neutral

Faucets

Ventilation

Pizzeria

Bakery

	7489.5500	7489.5505	7489.5510
	€ 2.185,-	€ 2.420,-	€ 3.160,-
	1400 x 700 x 850	1865 x 700 x 850	2330 x 700 x 850
	230 V / 0,04 kW	230 V / 0,05 kW	230 V / 0,05 kW
	281 L	474 L	632 L
	-2/+8°C	-2/+8°C	-2/+8°C
	R 290	R 290	R 290
	136	175	205

KOELWERKBANK

- Isolatie 50 mm
- Omgevingstemp. +43°C
- Incl. 1 rooster 1/1GN en geleiderset per deur
- Cap. 8 geleiders per deur
- Variabel, 40/80/10 mm

KÜHLTISCH

- Isolierschicht 50 mm
- Umgebungstemp. +43°C
- Einschließlich 1 Gitter 1/1GN mit Führungsschiene hinter jeden Tür
- Für maximal 8 Führungsschienen
- Variable, 40/80/10 mm

REFRIGERATED COUNTER

- Insulation 50 mm
- Ambient temp. +43°C
- Incl. 1 grids 1/1GN and set guides per door
- Cap. 8 guides per door
- Variable, 40/80/10 mm

TABLE RÉFRIGÉRÉE

- Isolation 50 mm
- Temp. ambiente +43°C
- 1 Grilles 1/1GN et Glissières par porte inclus
- Cap. 8 Glissières par porte
- Variable, 40/80/10 mm

7489.0506 € 65,-

Grids

7489.0905 € 90,-

Castors set (5x)

> 7489.5500 - 5505

7489.0910 € 100,-

Castors set (6x)

> 7489.5510

60Hz ON REQUEST

ON REQUEST





REFRIGERATED COUNTER

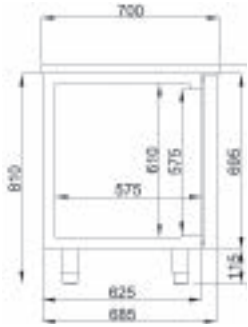
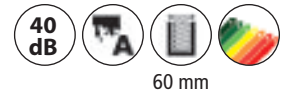

Cooking range

Drop-in

Ovens

Kitchen equipment

Refrigeration

Dishwashers

Neutral

Faucets

Ventilation

Pizzeria

Bakery

	7489.5100	7489.5105	7489.5110
	€ 2.410,-	€ 2.760,-	€ 3.325,-
	1300 x 700 x 850	1785 x 700 x 850	2270 x 700 x 850
	230 V / 0,12 kW	230 V / 0,20 kW	230 V / 0,40 kW
	281 L	474 L	632 L
	-2/+8°C	-2/+8°C	-2/+8°C
	R 290	R 290	R 290
	136	170	205

KOELWERKBANK

Monoblock

- Isolatie 60mm
- Omgevingstemp. +43°C
- Incl. 1 rooster 1/1GN en geleiderset per deur
- Cap. 8 geleiders per deur
- Variabel, 40/80/10mm

KÜHLTISCH

Monoblock

- Isolierschicht 60mm
- Umgebungstemp. +43°C
- Einschließlich 1 Gitter 1/1GN mit Führungsschiene hinter jeden Tür
- Für maximal 8 Führungsschienen
- Variable, 40/80/10mm

REFRIGERATED COUNTER

Monoblock

- Insulation 60mm
- Ambient temp. +43°C
- Incl. 1 grids 1/1GN and set guides per door
- Cap. 8 guides per door
- Variable, 40/80/10mm

TABLE RÉFRIGÉRÉE

Monoblock

- Isolation 60mm
- Temp. ambiente +43°C
- 1 Grilles 1/1GN et Glissières par porte inclus
- Cap. 8 Glissières par porte
- Variable, 40/80/10mm

7489.0506 € 65,-

Grids

7489.0905 € 90,-

Castors set (5x)

> 7489.5100-5105

7489.0910 € 100,-

Castors set (6x)

> 7489.5110

7489.0522 € 540,-

Drawers

7489.0524 € 535,-

Drawers

7489.0523 € 680,-

Drawers

60Hz ON REQUEST

ON REQUEST



Refrigeration

STANDARD LINE

REFRIGERATED COUNTER

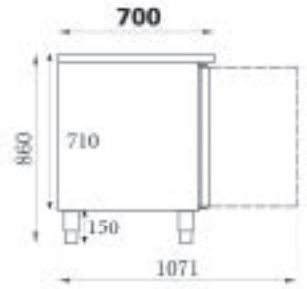

	7950.0200	7950.0205	7950.0210
	€ 1.740,-	€ 2.000,-	€ 2.350,-
	1360 x 700 x 850	1795 x 700 x 850	2230 x 700 x 850
	795 x 580 x 560	1230 x 580 x 560	1665 x 580 x 560
	230 V / 0,34 kW	230 V / 0,34 kW	230 V / 0,34 kW
	282 L	417 L	553 L
	+2/+8°C	+2/+8°C	+2/+8°C
	R 600 A	R 600 A	R 600 A
	115	160	190

KOELWERKBANK

- Isolatie 60mm
- Omgevingstemp. +38°C
- Vast ingebouwde compressor
- Incl. 1 rooster 1/GN en geleiderset per deur
- Cap. 12 geleiders per deur
- Ruimte tussen geleiders 40mm

KÜHLTISCH

- Isolierschicht 60mm
- Umgebungstemp. +38°C
- Fest installierte Kompressor
- Einschließlich 1 Gitter 1/1GN mit Führungsschiene hinter jeden Tür
- Für maximal 12 Führungsschienen
- Abstand zwischen Führungsschienen 40mm

REFRIGERATED COUNTER

- Insulation 60mm
- Ambient temp. +38°C
- Permanently installed compressor
- Incl. 1 grids 1/1GN and set guides per door
- Cap. 12 guides per door
- Space between guides 40mm

TABLE RÉFRIGÉRÉE

- Isolation 60mm
- Temp. ambiente +38°C
- Compresseur fixé
- 1 Grilles 1/1GN et Glissières par porte inclus
- Cap. 12 Glissières par porte
- Espace entre les Glissières 40mm

7950.5048 **€ 45,-**

Set guides

7450.0505 **€ 27,-**

Grids PE COATED
GN 1/1 GN

7020.1200 **€ 30,-**

Grids SS
GN 1/1 GN

7451.0010 **€ 83,-**

Castors set (4x)

7451.0009 **€ 121,-**

Castors set (6x)



REFRIGERATED COUNTER

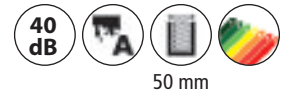

Cooking range

Drop-in

Ovens

Kitchen equipment

Refrigeration

Dishwashers

Neutral

Faucets

Ventilation

Pizzeria

Bakery

	7489.5515	7489.5520	7489.5525
	€ 2.685,-	€ 2.920,-	€ 3.660,-
	1400 x 700 x 850	1865 x 700 x 850	2330 x 700 x 850
	230 V / 0,05 kW	230 V / 0,05 kW	230 V / 0,06 kW
	281 L	474 L	632 L
	-2/+8°C	-2/+8°C	-2/+8°C
	R 290	R 290	R 290
	136	175	205

KOELWERKBANK

- Isolatie 50 mm
- Omgevingstemp. +43°C
- Incl. 1 rooster 1/1GN en geleiderset per deur
- Cap. 8 geleiders per deur
- Variabel, 40/80/10 mm

KÜHLTISCH

- Isolierschicht 50 mm
- Umgebungstemp. +43°C
- Einschließlich 1 Gitter 1/1GN mit Führungsschiene hinter jeden Tür
- Für maximal 8 Führungsschienen
- Variabel, 40/80/10 mm

REFRIGERATED COUNTER

- Insulation 50 mm
- Ambient temp. +43°C
- Incl. 1 grids 1/1GN and set guides per door
- Cap. 8 guides per door
- Variable, 40/80/10 mm

TABLE RÉFRIGÉRÉE

- Isolation 50 mm
- Temp. ambiante +43°C
- 1 Grilles 1/1GN et Glissières par porte inclus
- Cap. 8 Glissières par porte
- Variable, 40/80/10 mm

60Hz ON REQUEST

ON REQUEST

7489.0506 € 65,-

Grids

7489.0900 € 90,-

Castors set (4x)

> 7489.5515

7489.0905 € 90,-

Castors set (5x)

> 7489.5520

7489.0910 € 100,-

Castors set (6x)

> 7489.5525

REFRIGERATED COUNTER

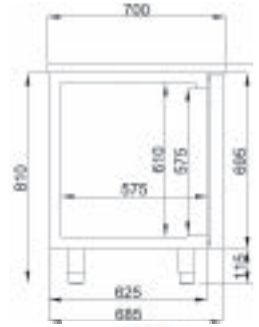

	7489.5350	7489.5355	7489.5360
	€ 2.515,-	€ 3.180,-	€ 3.770,-
	1300 x 700 x 850	1785 x 700 x 850	2270 x 700 x 850
	230 V / 0,12 kW	230 V / 0,20 kW	230 V / 0,40 kW
	281 L	474 L	632 L
	-2/+8°C	-2/+8°C	-2/+8°C
	R 290	R 290	R 290
	136	170	205

KOELWERKBANK

Monoblock

- Isolatie 60mm
- Omgevingstemp. +43°C
- Incl. 1 rooster 1/1GN en geleiderset per deur
- Cap. 8 geleiders per deur
- Variabel, 40/80/10mm

KÜHLTISCH

Monoblock

- Isolierschicht 60mm
- Umgebungstemp. +43°C
- Einschließlich 1 Gitter 1/1GN mit Führungsschiene hinter jeden Tür
- Für maximal 8 Führungsschienen
- Variable, 40/80/10mm

REFRIGERATED COUNTER

Monoblock

- Insulation 60mm
- Ambient temp. +43°C
- Incl. 1 grids 1/1GN and set guides per door
- Cap. 8 guides per door
- Variable, 40/80/10mm

TABLE RÉFRIGÉRÉE

Monoblock

- Isolation 60mm
- Temp. ambiente +43°C
- 1 Grilles 1/1GN et Glissières par porte inclus
- Cap. 8 Glissières par porte
- Variable, 40/80/10mm

60Hz ON REQUEST

ON REQUEST

7489.0506 **€ 65,-**

Grids

7489.0900 **€ 90,-**

Castors set (4x)

> 7489.5330

7489.0905 **€ 90,-**

Castors set (5x)

> 7489.5355

7489.0910 **€ 100,-**

Castors set (6x)

> 7489.5360



REFRIGERATED COUNTER

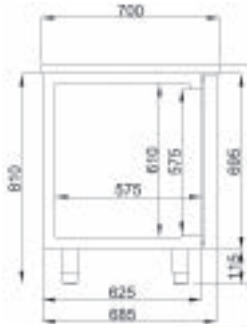
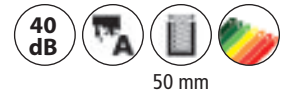

Cooking range

Drop-in

Ovens

Kitchen equipment

Refrigeration

Dishwashers

Neutral

Faucets

Ventilation

Pizzeria

Bakery

	7489.5555	7489.5560	7489.5565	7489.5570
	€ 3.200,-	€ 3.785,-	€ 3.665,-	€ 4.455,-
	1865 x 700 x 850	2330 x 700 x 850	1865 x 700 x 850	2330 x 700 x 850
	230 V / 0,05kW	230 V / 0,06 kW	230 V / 0,05 kW	230 V / 0,07 kW
	474 L	632 L	474 L	632 L
	-2/+8°C	-2/+8°C	-2/+8°C	-2/+8°C
	R 290	R 290	R 290	R 290
	175	205	175	205

KOELWERKBANK

- Isolatie 50mm
- Omgevingstemp. +43°C
- Incl. 1 rooster 1/1GN en geleiderset per deur
- Cap. 8 geleiders per deur
- Variabel, 40/80/10mm

KÜHLTISCH

- Isolierschicht 50mm
- Umgebungstemp. +43°C
- Einschließlich 1 Gitter 1/1GN mit Führungsschiene hinter jeden Tür
- Für maximal 8 Führungsschienen
- Variable, 40/80/10mm

REFRIGERATED COUNTER

- Insulation 50mm
- Ambient temp. +43°C
- Incl. 1 grids 1/1GN and set guides per door
- Cap. 8 guides per door
- Variable, 40/80/10mm

TABLE RÉFRIGÉRÉE

- Isolation 50mm
- Temp. ambiente +43°C
- 1 Grilles 1/1GN et Glissières par porte inclus
- Cap. 8 Glissières par porte
- Variable, 40/80/10mm

7489.0506 € 65,-

Grids

7489.0905 € 90,-

Castors set (5x)

> 7489.5555 - 5565

7489.0910 € 100,-

Castors set (6x)

> 7489.5560 - 5570

60Hz ON REQUEST

ON REQUEST



Refrigeration

STANDARD LINE

REFRIGERATED COUNTER

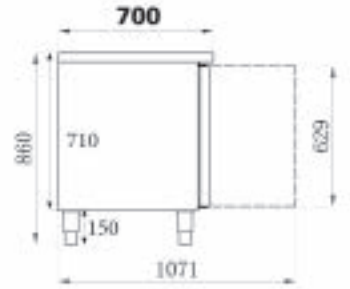

	7950.0215	7950.0220	7950.0225	7950.0230
	€ 2.295,-	€ 2.645,-	€ 2.035,-	€ 2.600,-
	1795 x 700 x 850	2230 x 700 x 850	1360 x 700 x 850	1795 x 700 x 850
	1230 x 580 x 560	1665 x 580 x 560	795 x 580 x 560	1230 x 580 x 560
	230 V / 0,34 kW	230 V / 0,34 kW	230 V / 0,34 kW	230 V / 0,34 kW
	417 L	553 L	282 L	417 L
	+2/+8°C	+2/+8°C	+2/+8°C	+2/+8°C
	R 600 A	R 600 A	R 600 A	R 600 A
	160	190	115	160

KOELWERKBANK

- Isolatie 60mm
- Omgevingstemp. +38°C
- Vast ingebouwde compressor
- Incl. 1 rooster 1/GN en geleiderset per deur
- Cap. 12 geleiders per deur
- Ruimte tussen geleiders 40mm

KÜHLTISCH

- Isolierschicht 60mm
- Umgebungstemp. +38°C
- Fest installierte Kompressor
- Einschließlich 1 Gitter 1/1GN mit Führungsschiene hinter jeden Tür
- Für maximal 12 Führungsschienen
- Abstand zwischen Führungsschienen 40mm

REFRIGERATED COUNTER

- Insulation 60mm
- Ambient temp. +38°C
- Permanently installed compressor
- Incl. 1 grids 1/1GN and set guides per door
- Cap. 12 guides per door
- Space between guides 40mm

TABLE RÉFRIGÉRÉE

- Isolation 60mm
- Temp. ambiente +38°C
- Compresseur fixé
- 1 Grilles 1/1GN et Glissières par porte inclus
- Cap. 12 Glissières par porte
- Espace entre les Glissières 40mm

7950.5048 **€ 45,-**

Set guides

7450.0505 **€ 27,-**

Grids PE COATED
GN 1/1 GN

7020.1200 **€ 30,-**

Grids SS
GN 1/1 GN

7451.0010 **€ 83,-**

Castors set (4x)

7451.0009 **€ 121,-**

Castors set (6x)



REFRIGERATED COUNTER

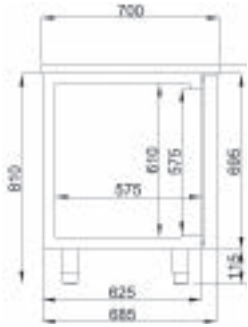
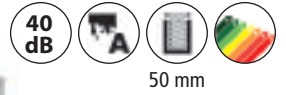

7489.5530



7489.5535



7489.5540



7489.5545



7489.5550

	7489.5530	7489.5535	7489.5540	7489.5545	7489.5550
	€ 3.420,-	€ 3.515,-	€ 3.200,-	€ 3.920,-	€ 4.995,-
	1585 x 700 x 850	2330 x 700 x 850	1400 x 700 x 850	1865 x 700 x 850	2330 x 700 x 850
	230 V / 0,05 kW	230 V / 0,06 kW	230 V / 0,05 kW	230 V / 0,05 kW	230 V / 0,07 kW
	474 L	632 L	281 L	474 L	632 L
	-2/+8°C	-2/+8°C	-2/+8°C	-2/+8°C	-2/+8°C
	R 290	R 290	R 290	R 290	R 290
	175	205	136	175	205

KOELWERKBANK

- Isolatie 50mm
- Omgevingstemp. +43°C
- Incl. 1 rooster 1/1GN en geleiderset per deur
- Cap. 8 geleiders per deur
- Variabel, 40/80/10mm

KÜHLTISCH

- Isolierschicht 50mm
- Umgebungstemp. +43°C
- Einschließlich 1 Gitter 1/1GN mit Führungsschiene hinter jeden Tür
- Für maximal 8 Führungsschienen
- Variabel, 40/80/10mm

REFRIGERATED COUNTER

- Insulation 50mm
- Ambient temp. +43°C
- Incl. 1 grids 1/1GN and set guides per door
- Cap. 8 guides per door
- Variable, 40/80/10mm

TABLE RÉFRIGÉRÉE

- Isolation 50mm
- Temp. ambiante +43°C
- 1 Grilles 1/1GN et Glissières par porte inclus
- Cap. 8 Glissières par porte
- Variable, 40/80/10mm

60Hz ON REQUEST

ON REQUEST

7489.0506 **€ 65,-**

Grids

7489.0900 **€ 90,-**

Castors set (4x)

> 7489.5540

7489.0905 **€ 90,-**

Castors set (5x)

> 7489.5530-5545

7489.0910 **€ 100,-**

Castors set (6x)

> 7489.5535-5550

REFRIGERATED COUNTER



	7489.5365	7489.5370	7489.5375	7489.5380
	€ 3.700,-	€ 4.295,-	€ 3.330,-	€ 4.230,-
	1785 x 700 x 850	2270 x 700 x 850	1300 x 700 x 850	1785 x 700 x 850
	230 V / 0,2 kW	230 V / 0,4 kW	230 V / 0,12 kW	230 V / 0,2 kW
	474 L	632 L	281 L	474 L
	-2/+8°C	-2/+8°C	-2/+8°C	-2/+8°C
	R 290	R 290	R 290	R 290
	170	205	136	170

KOELWERKBANK

Monoblock

- Isolatie 60mm
- Omgevingstemp. +43°C
- Incl. 1 rooster 1/1GN en geleiderset per deur
- Cap. 8 geleiders per deur
- Variabel, 40/80/10mm

KÜHLTISCH

Monoblock

- Isolierschicht 60mm
- Umgebungstemp. +43°C
- Einschließlich 1 Gitter 1/1GN mit Führungsschiene hinter jeden Tür
- Für maximal 8 Führungsschienen
- Variabel, 40/80/10mm

REFRIGERATED COUNTER

Monoblock

- Insulation 60mm
- Ambient temp. +43°C
- Incl. 1 grids 1/1GN and set guides per door
- Cap. 8 guides per door
- Variable, 40/80/10mm

TABLE RÉFRIGÉRÉE

Monoblock

- Isolation 60mm
- Temp. ambiente +43°C
- 1 Grilles 1/1GN et Glissières par porte inclus
- Cap. 8 Glissières par porte
- Variable, 40/80/10mm

60Hz ON REQUEST

ON REQUEST

7489.0506 **€ 65,-**

Grids

7489.0900 **€ 90,-**

Castors set (4x)

> 7489.5375

7489.0905 **€ 90,-**

Castors set (5x)

> 7489.5365-5380

7489.0910 **€ 100,-**

Castors set (6x)

> 7489.5370



REFRIGERATED COUNTER

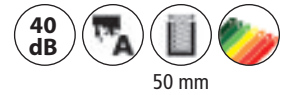

Cooking range

Drop-in

Ovens

Kitchen equipment

Refrigeration

Dishwashers

Neutral

Faucets

Ventilation

Pizzeria

Bakery

	7489.5575	7489.5580	7489.5585
	€ 3.435,-	€ 4.495,-	€ 5.660,-
	1400 x 700 x 850	1865 x 700 x 850	2330 x 700 x 850
	230 V / 0,05 kW	230 V / 0,06 kW	230 V / 0,08 kW
	281 L	474 L	632 L
	-2/+8°C	-2/+8°C	-2/+8°C
	R 290	R 290	R 290
	136	175	205

KOELWERKBANK

- Isolatie 50 mm
- Omgevingstemp. +43°C
- Incl. 1 rooster 1/1GN en geleiderset per deur
- Cap. 8 geleiders per deur
- Variabel, 40/80/10 mm

KÜHLTISCH

- Isolierschicht 50 mm
- Umgebungstemp. +43°C
- Einschließlich 1 Gitter 1/1GN mit Führungsschiene hinter jeden Tür
- Für maximal 8 Führungsschienen
- Variable, 40/80/10 mm

REFRIGERATED COUNTER

- Insulation 50 mm
- Ambient temp. +43°C
- Incl. 1 grids 1/1GN and set guides per door
- Cap. 8 guides per door
- Variable, 40/80/10 mm

TABLE RÉFRIGÉRÉE

- Isolation 50 mm
- Temp. ambiante +43°C
- 1 Grilles 1/1GN et Glissières par porte inclus
- Cap. 8 Glissières par porte
- Variable, 40/80/10 mm

60Hz ON REQUEST

ON REQUEST

7489.0506 € 65,-

Grids

7489.0900 € 90,-

Castors set (4x)

> 7489.5575

7489.0905 € 90,-

Castors set (5x)

> 7489.5580

7489.0910 € 100,-

Castors set (6x)

> 7489.5585



Refrigeration

STANDARD LINE

REFRIGERATED COUNTER



42 dB



60 mm

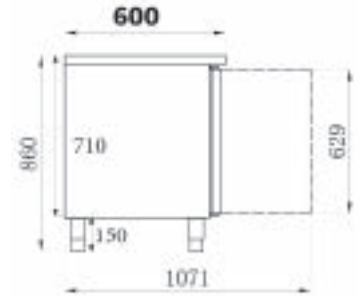

7450.0118

€ 1.320,-

7450.0116

€ 1.560,-

7450.0114

€ 1.890,-



1360 x 600 x 850

1795 x 600 x 850

2230 x 600 x 850



795 x 480 x 560

1230 x 480 x 560

1665 x 480 x 560



230 V / 0,34 kW

230 V / 0,34 kW

230 V / 0,34 kW



260 L

386 L

511 L



+2/+8°C

+2/+8°C

+2/+8°C



R 600 A

R 600 A

R 600 A



103

145

163

KOELWERKBANK

- Isolatie 60 mm
- Omgevingstemp. +38°C
- Vast ingebouwde compressor
- Incl. 1 rooster en geleiderset per deur

KÜHLTISCH

- Isolierschicht 60 mm
- Umgebungstemp. +38°C
- Fest installierte Kompressor
- Einschließlich 1 Gitter mit Führungsschiene hinter jeden Tür

REFRIGERATED COUNTER

- Insulation 60 mm
- Ambient temp. +38°C
- Permanently installed compressor
- Incl. 1 grids and set guides per door

TABLE RÉFRIGÉRÉE

- Isolation 60 mm
- Temp. ambiente +38°C
- Compresseur fixé
- 1 Grilles et Glissières par porte inclus

7451.0150

€ 25,-



Grids

328x430

7451.0010

€ 83,-



Castors set (4x)

7451.0009

€ 121,-



Castors set (6x)

7451.0155

€ 33,-



Set guides

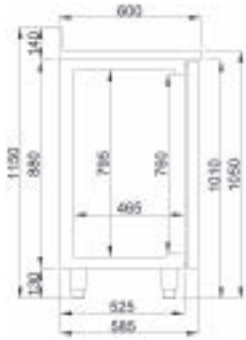

REFRIGERATED COUNTER UPSTAND

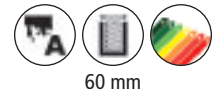

Cooking range

Drop-in

Ovens

Kitchen equipment

Refrigeration

Dishwashers

Neutral

Faucets

Ventilation

Pizzeria

Bakery



	7489.5260	7489.5265
	€ 3.000,-	€ 3.600,-
	1580 x 600 x 1050	2135 x 600 x 1050
	230 V / 0,3 kW	230 V / 0,36 kW
	550 L	632 L
	-2/+8°C	-2/+8°C
	R 290	R 290
GN	2x 1/1 GN	3x 1/1 GN
	2x	3x
	170	200

**KOELWERKBANK
OPSTAANDE RAND**

- Isolatie 60mm
- Omgevingstemp. +43°C
- Vast ingebouwde compressor
- Incl. 1 rooster 1/1GN per deur
- Incl. afkloplade voor koffie

**KÜHLTISCH
AUFKANTUNG**

- Isolierschicht 60mm
- Umgebungstemp. +43°C
- Fest installierte Kompressor
- Einschließlich 1 Gitter 1/1GN hinter jeden Tür
- Mit Schublade für Kaffee

**REFRIGERATED COUNTER
UPSTAND**

- Insulation 60mm
- Ambient temp. +43°C
- Permanently installed compressor
- Incl. 1 grids 1/1GN per door
- With disposal drawer for coffee

**TABLE RÉFRIGÉRÉE
BORD RELEVÉ**

- Isolation 60mm
- Temp. ambiente +43°C
- Compresseur fixé
- 1 Grilles 1/1GN par porte inclus
- Avec tiroir pour café

7489.0905 € 90,-

Castors set (5x)

7489.0545 € 480,-

Drawers

60Hz ON REQUEST

ON REQUEST



Refrigeration

STANDARD LINE

REFRIGERATED COUNTER UPSTAND



42 dB



60 mm

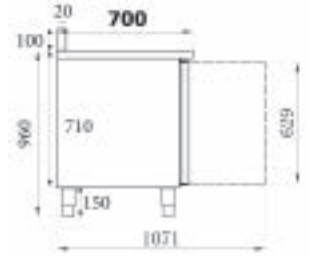

7450.0780

€ 1.555,-

7450.0782

€ 1.845,-

7450.0784

€ 2.230,-



1360 x 700 x 850

1795 x 700 x 850

2230 x 700 x 850



795 x 580 x 560

1230 x 580 x 560

1665 x 580 x 560



230 V / 0,34 kW

230 V / 0,34 kW

230 V / 0,34 kW



314 L

465 L

616 L



+2/+8°C

+2/+8°C

+2/+8°C



R 600 A

R 600 A

R 600 A



115

160

190



KOELWERKBANK OPSTAANDE RAND

- Isolatie 60mm
- Omgevingstemp. +43°C
- Vast ingebouwde compressor
- Incl. 1 rooster 1/GN en geleiderset per deur



KÜHLTISCH AUFKANTUNG

- Isolierschicht 60mm
- Umgebungstemp. +43°C
- Fest installierte Kompressor
- Einschließlich 1 Gitter 1/1GN mit Führungsschiene hinter jeden Tür



REFRIGERATED COUNTER UPSTAND

- Insulation 60mm
- Ambient temp. +43°C
- Permanently installed compressor
- Incl. 1 grids 1/1GN and set guides per door



TABLE RÉFRIGÉRÉE BORD RELEVÉ

- Isolation 60mm
- Temp. ambiente +43°C
- Compresseur fixé
- 1 Grilles 1/1GN et Glissières par porte inclus

7450.0505

€ 27,-



Grids PE COATED

GN 1/1 GN

7020.1200

€ 30,-



Grids SS

GN 1/1 GN

7451.0010

€ 83,-



Castors set (4x)

7451.0009

€ 121,-



Castors set (6x)

7451.0005

€ 690,-



Drawers

7950.5048

€ 45,-



Set guides

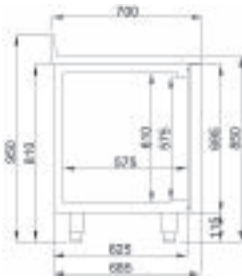

REFRIGERATED COUNTER UPSTAND

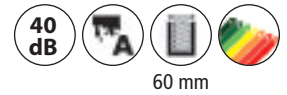

Cooking range

Drop-in

Ovens

Kitchen equipment

Refrigeration

Dishwashers

Neutral

Faucets

Ventilation

Pizzeria

Bakery



	7489.5400	7489.5405	7489.5410
	€ 2.355,-	€ 2.750,-	€ 3.355,-
	1300 x 700 x 860	1785 x 700 x 860	2270 x 700 x 860
	230 V / 0,12 kW	230 V / 0,20 kW	230 V / 0,40 kW
	281 L	474 L	632 L
	-2/+8°C	-2/+8°C	-2/+8°C
	R 290	R 290	R 290
	136	170	205

KOELWERKBANK OPSTAANDE RAND

Monoblock

- Isolatie 60mm
- Omgevingstemp. +43°C
- Incl. 1 rooster 1/1GN en geleiderset per deur
- Cap. 8 geleiders per deur
- Variabel, 40/80/10mm

KÜHLTISCH AUFKANTUNG

Monoblock

- Isolierschicht 60mm
- Umgebungstemp. +43°C
- Einschließlich 1 Gitter 1/1GN mit Führungsschiene hinter jeden Tür
- Für maximal 8 Führungsschienen
- Variable, 40/80/10mm

REFRIGERATED COUNTER UPSTAND

Monoblock

- Insulation 60mm
- Ambient temp. +43°C
- Incl. 1 grids 1/1GN and set guides per door
- Cap. 8 guides per door
- Variable, 40/80/10mm

TABLE RÉFRIGÉRÉE BORD RELEVÉ

Monoblock

- Isolation 60mm
- Temp. ambiente +43°C
- 1 Grilles 1/1GN et Glissières par porte inclus
- Cap. 8 Glissières par porte
- Variable, 40/80/10mm

7489.0544 € 100,-

Grids

7489.0522 € 540,-

Drawers

7489.0524 € 535,-

Drawers

7489.0523 € 680,-

Drawers

7489.0900 € 90,-

Castors set (4x)

> 7489.5400

7489.0905 € 90,-

Castors set (5x)

> 7489.5405

7489.0910 € 100,-

Castors set (6x)

> 7489.5410

60Hz ON REQUEST

ON REQUEST



Refrigeration

STANDARD LINE

REFRIGERATED COUNTER

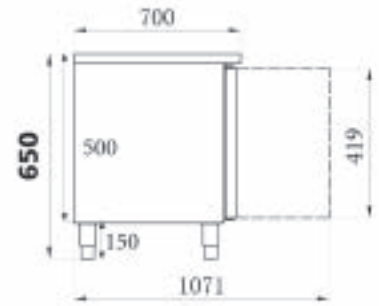

	7450.0755	7450.0760	7450.0765
	€ 1.600,-	€ 1.825,-	€ 1.990,-
	1360 x 700 x 650	1795 x 700 x 650	2230 x 700 x 650
	795 x 580 x 340	1230 x 580 x 340	1665 x 580 x 340
	230 V / 0,34 kW	230 V / 0,34 kW	230 V / 0,34 kW
	214 L	317 L	420 L
	+2/+8°C	+2/+8°C	+2/+8°C
	R 600 A	R 600 A	R 600 A
	85	130	160

KOELWERKBANK

- Isolatie 60mm
- Omgevingstemp. +43°C
- Vast ingebouwde compressor
- Incl. 1 rooster 1/1GN en geleiderset per deur

KÜHLTISCH

- Isolierschicht 60mm
- Umgebungstemp. +43°C
- Fest installierte Kompressor
- Einschließlich 1 Gitter 1/1GN mit Führungsschiene hinter jeden Tür

REFRIGERATED COUNTER

- Insulation 60mm
- Ambient temp. +43°C
- Permanently installed compressor
- Incl. 1 grids 1/1GN and set guides per door

TABLE RÉFRIGÉRÉE

- Isolation 60mm
- Temp. ambiente +43°C
- Compresseur fixé
- 1 Grilles 1/1GN et Glissières par porte inclus

7450.0505 **€ 27,-**

	Grids PE COATED
GN	1/1 GN

7020.1200 **€ 30,-**

	Grids SS
GN	1/1 GN

7450.0500 **€ 35,-**

	Set guides
--	------------

7451.0010 **€ 83,-**

	Castors set (4x)
--	------------------

7451.0009 **€ 121,-**

	Castors set (6x)
--	------------------

7451.0195 **€ 650,-**

	Drawers
--	---------

7451.0190 **€ 540,-**

	Drawer
--	--------



REFRIGERATED COUNTER

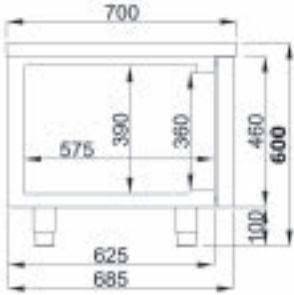
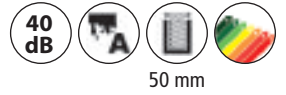

Cooking range

Drop-in

Ovens

Kitchen equipment

Refrigeration

Dishwashers

Neutral

Faucets

Ventilation

Pizzeria

Bakery

	7489.5075	7489.5080	7489.5082
	€ 2.420,-	€ 2.765,-	€ 3.410,-
	1200 x 700 x 600	1600 x 700 x 600	2130 x 700 x 600
	230 V / 0,17 kW	230 V / 0,23 kW	230 V / 0,35 kW
	180 L	280 L	360 L
	-2/+8°C	-2/+8°C	-2/+8°C
	R 290	R 290	R 290
	112	145	165

KOELWERKBANK

- Isolatie 50mm
- Omgevingstemp. +43°C
- Vast ingebouwde compressor
- Incl. 1 rooster 1/1GN en geleiderset per deur

KÜHLTISCH

- Isolierschicht 50mm
- Umgebungstemp. +43°C
- Fest installierte Kompressor
- Einschließlich 1 Gitter 1/1GN mit Führungsschiene hinter jeden Tür

REFRIGERATED COUNTER

- Insulation 50mm
- Ambient temp. +43°C
- Permanently installed compressor
- Incl. 1 grids 1/1GN and set guides per door

TABLE RÉFRIGÉRÉE

- Isolation 50mm
- Temp. ambiente +43°C
- Compresseur fixé
- 1 Grilles 1/1GN et Glissières par porte inclus

7489.0506 € 65,-

Grids

60Hz ON REQUEST

ON REQUEST

7489.0905 € 90,-

Castors set (5x)

> 7489.5075 - 5080

7489.0910 € 100,-

Castors set (6x)

> 7489.5082

7489.0521 € 440,-

Drawers

7489.0520 € 280,-

Drawers

REFRIGERATED COUNTER WITH DRAWERS

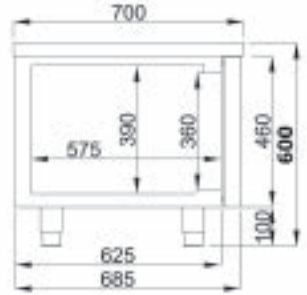

	7489.5475	7489.5480	7489.5482
	€ 2.900,-	€ 3.560,-	€ 4.470,-
	1200 x 700 x 600	1600 x 700 x 600	2130 x 700 x 600
	230 V / 0,17 kW	230 V / 0,23 kW	230 V / 0,35 kW
	180 L	280 L	360 L
	-2/+8°C	-2/+8°C	-2/+8°C
	R 290	R 290	R 290
	112	145	165



KOELWERKBANK MET LADEN

- Isolatie 50mm
- Omgevingstemp. +43°C
- Vast ingebouwde compressor

KÜHLTISCH MIT SCHUBLADEN

- Isolierschicht 50mm
- Umgebungstemp. +43°C
- Fest installierte Kompressor

REFRIGERATED COUNTER WITH DRAWERS

- Insulation 50mm
- Ambient temp. +43°C
- Permanently installed compressor

TABLE RÉFRIGÉRÉE AVEC TIROIRS

- Isolation 50mm
- Temp. ambiente +43°C
- Compresseur fixé

7489.0905 € 90,-

Castors set (5x)

> 7489.5475-5480

7489.0910 € 100,-

Castors set (6x)

> 7489.5482

60Hz ON REQUEST

ON REQUEST



REFRIGERATED/FREEZER COUNTER WITH DRAWERS



50 mm



	7450.0230	7450.0235	7450.0240	7450.0245
	€ 1.895,-	€ 2.410,-	€ 2.750,-	€ 3.440,-
	905 x 700 x 575	1230 x 700 x 575	905 x 700 x 840	1230 x 700 x 840
	675 x 565 x 205	1000 x 565 x 205	675 x 565 x 470	1000 x 565 x 470
	230 V / 0,24 kW	230 V / 0,27 kW	230 V / 0,46 kW	230 V / 0,5 kW
	78 L	116 L	179 L	265 L
	+1/+4 / -18/-21°C	+1/+4 / -18/-21°C	+1/+4 / -18/-21°C	+1/+4 / -18/-21°C
	R 290	R 290	R 290	R 290
GN	2x 1/1GN	3x 1/1GN	4x 1/1GN	6x 1/1GN
	82	105	125	154

**KOEL-/VRIESWERKBANK
MET LADEN**

- Door schakelaar te wisselen tussen koeler en vriezer
- Isolatie 50 mm
- Omgevingstemp. +43°C
- Vast ingebouwde compressor
- Geforceerde koeling
- Automatische ontdooiing
- Lade 1/1GN, max. hoogte 150 mm

**KÜHL-/TIEFKÜHLTISCH
MIT SCHUBLADEN**

- Per Schalter zwischen Kühl- und Gefrierschrank umschaltbar
- Isolierschicht 50 mm
- Umgebungstemp. +43°C
- Fest installierte Kompressor
- Umluft Kühlung
- Automatische Abtauung
- Schublade 1/1 GN, max. Höhe 150 mm

**REFRIGERATED/FREEZER
COUNTER WITH
DRAWERS**

- Interchangeable between cooler and freezer
- Insulation 50 mm
- Ambient temp. +43°C
- Permanently installed compressor
- Ventilated cooling
- Automatic defrost
- Drawer 1/1 GN, Max. height 150 mm

**TABLE RÉFRIGÉRÉE/
CONGÉLATEUR AVEC
TIROIRSE**

- Interchangeable entre réfrigérateur et congélateur par interrupteur
- Isolation 50 mm
- Temp. ambiente +43°C
- Compresseur fixé
- Froid renforcé
- Dégivrage automatique
- Tiroir 1/1 GN, hauteur max. 150 mm

Cooking range

Drop-in

Ovens

Kitchen equipment

Refrigeration

Dishwashers

Neutral

Faucets

Ventilation

Pizzeria

Bakery

REFRIGERATED COUNTER

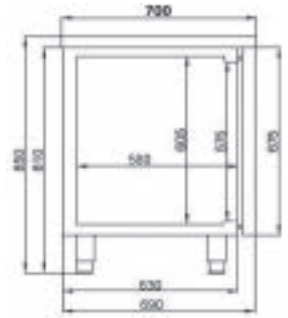

	7489.5085	7489.5090	7489.5095
	€ 2.680,-	€ 3.095,-	€ 3.880,-
	1125 x 700 x 850	1600 x 700 x 850	2060 x 700 x 850
	230 V / 0,13 kW	230 V / 0,24 kW	230 V / 0,23 kW
	281 L	474 L	632 L
	+2/+8°C	+2/+8°C	+2/+8°C
	85	115	145

KOELWERKBANK

- Isolatie 50 mm
- Omgevingstemp. +32°C
- Incl. 1 rooster 1/1GN en geleiderset per deur

Excl. motor, op aanvraag

KÜHLTISCH

- solierschicht 50 mm
- Umgebungstemp. +32°C
- Einschließlich 1 Gitter 1/1GN mit Führungsschiene hinter jeden Tür

Exklusiv Motor, auf Anfrage

REFRIGERATED COUNTER

- Insulation 50 mm
- Ambient temp. +32°C
- Incl. 1 grids 1/1GN and set guides per door

Excl. Motor, on request

TABLE RÉFRIGÉRÉE

- Isolation 50 mm
- Temp. ambiente +32°C
- 1 Grilles 1/1GN et Glissières par porte inclus

Excl. Le moteur, sur demande

7489.0905 **€ 90,-**

Castors set (5x)

> 7489.5085-5090

7489.0910 **€ 100,-**

Castors set (6x)

> 7489.5095

60Hz **ON REQUEST**

ON REQUEST

7489.0506 **€ 65,-**

Grids

7489.0525 **€ 515,-**

Drawers

7489.0527 **€ 505,-**

Drawer

7489.0526 **€ 540,-**

Drawer



REFRIGERATED COUNTER

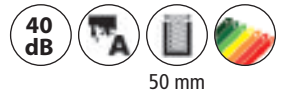

50 mm



Cooking range

Drop-in

Ovens

Kitchen equipment

Refrigeration

Dishwashers

Neutral

Faucets

Ventilation

Pizzeria

Bakery

	7489.5160	7489.5165	7489.5167
	€ 2.490,-	€ 2.955,-	€ 3.580,-
	1400 x 700 x 850	1865 x 700 x 850	2330 x 700 x 850
	230 V / 0,25 kW	230 V / 0,35 kW	230 V / 0,45 kW
	281 L	474 L	632 L
	-2/+8°C	-2/+8°C	-2/+8°C
	R 290	R 290	R 290
	145	170	195

KOELWERKBANK

- Isolatie 50 mm
- Omgevingstemp. +43°C
- Vast ingebouwde compressor
- Incl. 1 rooster 1/1GN en geleiderset per deur
- Gekoelde lade boven motor

KÜHLTISCH

- Isolierschicht 50 mm
- Umgebungstemp. +43°C
- Fest installierte Kompressor
- Einschließlich 1 Gitter 1/1GN mit Führungsschiene hinter jeden Tür
- Gekühltes Schubfach über dem Motor

REFRIGERATED COUNTER

- Insulation 50 mm
- Ambient temp. +43°C
- Permanently installed compressor
- Incl. 1 grids 1/1GN and set guides per door
- Cold drawer above motor

TABLE RÉFRIGÉRÉE

- Isolation 50 mm
- Temp. ambiente +43°C
- Compresseur fixé
- 1 Grilles 1/1GN et Glissières par porte inclus
- tiroir réfrigéré au-dessus de moteur

7489.0905 **€ 90,-**

Castors set (5x)

> 7489.5160-5165

7489.0910 **€ 100,-**

Castors set (6x)

> 7489.5167

60Hz **ON REQUEST**

ON REQUEST

7489.0506 **€ 65,-**

Grids

7489.0525 **€ 515,-**

Drawers

7489.0527 **€ 505,-**

Drawer

7489.0526 **€ 540,-**

Drawer



Refrigeration

STANDARD LINE

REFRIGERATED NEGATIVE COUNTER

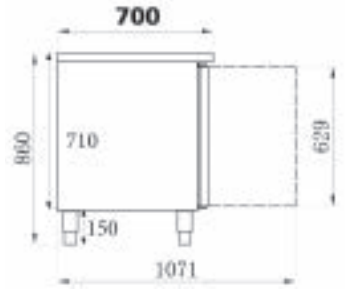
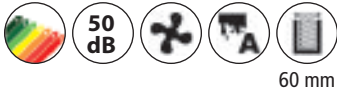

Refrigerators & Freezer Cabinets

Refrigerated & Freezer Counters

Saladettes

Coldrooms

Chest Freezers

Display Refrigeration

Ice Machines



	7450.0081	7450.0083
	€ 1.750,-	€ 2.010,-
	1360 x 700 x 860	1795 x 700 x 860
	795 x 580 x 560	1280 x 580 x 560
	230 V / 0,34 kW	230 V / 0,34 kW
	272 L	402 L
	-10/-20°C	-10/-20°C
	R 290	R 290
	103	145

VRIESWERKBANK

- Isolatie 60mm
- Omgevingstemp. +43°C
- Vast ingebouwde compressor
- Incl. 1 rooster 1/1GN en geleiderset per deur

TIEFKÜHLTISCH

- Isolierschicht 60mm
- Umgebungstemp. +43°C
- Fest installierte Kompressor
- Einschließlich 1 Gitter 1/1GN mit Führungsschiene hinter jeden Türhine hinter jeden Tür

REFRIGERATED NEGATIVE COUNTER

- Insulation 60mm
- Ambient temp. +43°C
- Permanently installed compressor
- Incl. 1 grids 1/1GN and set guides per door

TABLE CONGÉLATEUR

- Isolation 60mm
- Temp. ambiente +43°C
- Compresseur fixé
- 1 Grilles 1/1GN et Glissières par porte inclus

7950.5048 € 45,-

Set guides

7450.0505 € 27,-

Grids PE COATED
GN 1/1 GN

7020.1200 € 30,-

Grids SS
GN 1/1 GN

7451.0010 € 83,-

Castors set (4x)
> 7450.0081

7451.0009 € 121,-

Castors set (6x)
> 7450.0083



REFRIGERATED NEGATIVE COUNTER

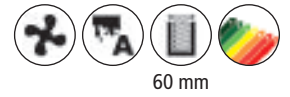

60 mm



Cooking range

Drop-in

Ovens

Kitchen equipment

	7489.5130	7489.5135
	€ 4.055,-	€ 4.170,-
	1300 x 700 x 850	1785 x 700 x 850
	1400 x 800 x 1050	1880 x 800 x 1050
	230 V / 0,17 kW	230 V / 0,18 kW
	281 L	474 L
	-10/-22°C	-10/-22°C
	R 290	R 290
	160	170

Refrigeration

Dishwashers

Neutral

VRIESWERKBANK

Monoblock

- Isolatie 60mm
- Omgevingtemp. +43°C
- Vast ingebouwde compressor
- Incl. 1 rooster 1/1GN en geleiderset per deur

TIEFKÜHLTISCH

Monoblock

- Isolierschicht 60mm
- Umgebungtemp. +43°C
- Fest installierte Kompressor
- Einschließlich 1 Gitter 1/1GN mit Führungsschiene hinter jeden Tür

REFRIGERATED NEGATIVE COUNTER

Monoblock

- Insulation 60mm
- Ambient temp. +43°C
- Permanently installed compressor
- Incl. 1 grids 1/1GN and set guides per door

TABLE CONGÉLATEUR

Monoblock

- Isolation 60mm
- Temp. ambiente +43°C
- Compresseur fixé
- 1 Grilles 1/1GN et Glissières par porte inclus

Faucets

Ventilation

Pizzeria

7489.0506 € 65,-

Grids

7489.0905 € 90,-

Castors set (5x)

60Hz ON REQUEST

ON REQUEST

Bakery



REFRIGERATED COUNTER SINK

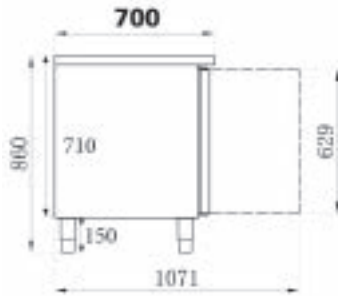
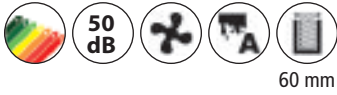

Refrigerators & Freezer Cabinets

Refrigerated & Freezer Counters

Saladettes

Coldrooms

Chest Freezers

Display Refrigeration

Ice Machines

	7450.0210	7450.0215
	€ 2.180,-	€ 2.465,-
	1510 x 700 x 860	2020 x 700 x 860
	795 x 580 x 560	1230 x 580 x 560
	400 x 400 x 200	400 x 400 x 200
	230 V / 0,35 kW	230 V / 0,35 kW
	-2/+8°C	-2/+8°C
	R 600 A	R 600 A
	2x 1/1GN	3x 1/1GN
	115	160

KOELWERKBANK SPOELBAK

- Isolatie 60mm
- Omgevingstemp. +38°C
- Digitale thermostaat
- Verstelbare roosters
- Rilsan roosters
- Incl. 1 rooster 1/1GN en 1 geleiderset per deur
- Cap. 12 geleiders per deur
- Ruimte tussen geleiders 40mm

KÜHLTISCH SPÜLBECKE

- Isolierschicht 60mm
- Umgebungstemperatur +38°C
- Digitales Thermostat
- Einstellbare Gitter austauschbar
- Rilsan Gitter
- Inkl. 1 Gitter 1/1GN und 1 Paar Führungsschienen pro Tür
- Kapazität 12 Paar Führungsschienen pro Tür
- Abstand zwischen Führungsschienen 40mm

REFRIGERATED COUNTER SINK

- Insulation 60mm
- Ambient temp. +38°C
- Digital thermostat
- Adjustable shelves
- Rilsan shelves
- Incl. 1 shelves 1/1 GN and 1 set guides per door
- Capacity 12 guides per door
- Space between guides 40mm

TABLE RÉFRIGÉRÉE PLONGER

- Isolation 60mm
- Temp. Ambiante + 38°C
- Thermostat numérique
- Tablettes réglables
- Étagères Rilsan
- Incl. 1 étagère 1/1 GN et 1 jeu de guide par porte
- Capacité 12 guides par porte
- Espace entre les guides 40mm

7450.0500 **€ 35,-**



Set guides

7450.0505 **€ 27,-**



Grids PE COATED

GN 1/1 GN

7020.1200 **€ 30,-**



Grids SS

GN 1/1 GN

7451.0010 **€ 83,-**



Castors set (4x)

> 7450.0210

7451.0009 **€ 121,-**



Castors set (6x)

> 7450.0215



REFRIGERATED COUNTER WITH GLASS COVER



Cooking range

Drop-in

Ovens

7950.0420	7950.0422	7950.0425
€ 3.495,-	€ 2.990,-	€ 3.530,-
4x 1/1GN PAN	3x 1/1 GN PAN + 3x1/6GN PAN	5x 1/1GN PAN

Kitchen equipment

	1510 x 800 x 1365	1360 x 700 x 1365	1795 x 700 x 1365
	945 x 680 x 560	795 x 580 x 560	1230 x 580 x 560
	230 V / 0,1 kW	230 V / 0,20 kW	230 V / 0,2 kW
	428 L	314 L	456 L
	+2/+8°C	+2/+8°C	+2/+8°C
	R 290	R 290	R 290
	2x 600x400	2x 1/1GN	3x 1/1GN
	130	120	142

Refrigeration

Dishwashers

Neutral

KOELWERKBANK GLASOPSTAND

- Isolatie 60mm
- Omgevingstemp. +32°C
- Vast ingebouwde compressor
- Incl. 1 rooster en geleidersets per deur
- Cap. 10 geleiders per deur
- Ruimte tussen geleiders 55mm
- Rechte glasopzet
- Incl. schuifruitjes aan de bedieningskant

KÜHLTISCH MIT GLAS

- Isolierschicht 60mm
- Umgebungstemp. +32°C
- Fest installierte Kompressor
- Einschließlich 1 Gitter mit Führungsschiene hinter jeden Tür
- Für maximal 10 Führungsschienen
- Abstand zwischen Führungsschienen 55mm
- Gerade Glasaufsatz
- Inkl. schiebe glastüren an der bedienung seite

REFRIGERATED COUNTER WITH GLASS COVER

- Insulation 60mm
- Ambient temp. +32°C
- Permanently installed compressor
- Incl. 1 grid and set guides per door
- Cap. 10 guides per door
- Space between guides 55mm
- Straight glass cover
- Incl. sliding glass doors on the operating side

TABLE RÉFRIGÉRÉE AVEC VERRE

- Isolation 60mm
- Temp. ambiente +32°C
- Compresseur fixé
- Straight glass cover
- Cap. 10 Glissières par porte
- Espace entre les Glissières 55mm
- Structure en verre droite
- Incl. portes coulissantes du côté commande

Faucets

Ventilation

7450.0505 € 27,-

Grids PE COATED

GN 1/1 GN

7020.1200 € 30,-

Grids SS

GN 1/1 GN

7020.1210 € 35,-

Grids

600x400

Pizzeria

7451.0010 € 83,-

Castors set (4x)

> 7950.0420-0422

7451.0009 € 121,-

Castors set (6x)

> 7950.0425

7450.0500 € 35,-

Set guides

> 7950.0422-0425

7451.0255 € 30,-

Set guides

> 7950.0420

Bakery



Refrigeration

STANDARD LINE

REFRIGERATED COUNTER WITH GLASS COVER

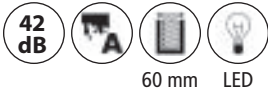

Refrigerators & Freezer Cabinets

Refrigerated & Freezer Counters

Saladettes

Coldrooms

Chest Freezers

Display Refrigeration

Ice Machines

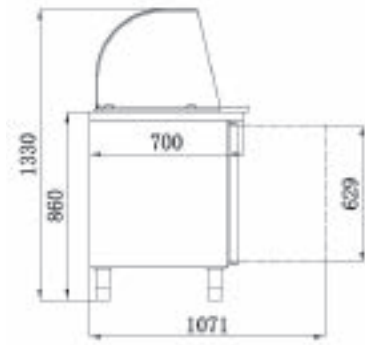

	7950.0410	7950.0415
	€ 2.215,-	€ 2.405,-
	1360 x 700 x 1365	1795 x 700 x 1365
	230 V / 0,34 kW	230 V / 0,34 kW
	314 L	465 L
	+2/+8°C	+2/+8°C
	R 600 A	R 600 A
	115	160

KOELWERKBANK GLASOPSTAND

- Isolatie 60mm
- Omgevingstemp. +32°C
- Vast ingebouwde compressor
- Incl. 1 rooster 1/GN en geleiderset per deur
- Gebogen glasopzet
- 2 of 3x 1/1GN inzet

KÜHLTISCH MIT GLAS

- Isolierschicht 60mm
- Umgebungstemp. +32°C
- Fest installierte Kompressor
- Einschließlich 1 Gitter 1/1GN mit Führungsschiene hinter jeden Tür
- Gebogen Glasaufsatz
- 2 oder 3x 1/1GN einsetz

REFRIGERATED COUNTER WITH GLASS COVER

- Insulation 60mm
- Ambient temp. +32°C
- Permanently installed compressor
- Incl. 1 grids 1/1GN and set guides per door
- Curved glass cover
- 2 or 3x 1/1 GN insert

TABLE RÉFRIGÉRÉE AVEC VERRE

- Isolation 60mm
- Temp. ambiente +32°C
- Compresseur fixé
- 1 Grilles 1/1GN et Glissières par porte inclus
- Structure en verre curbé
- 2 ou 3x 1/1 GN insert

7450.0500 € 35,-

Set guides

7450.0505 € 27,-

Grids PE COATED
GN 1/1 GN

7020.1200 € 30,-

Grids SS
GN 1/1 GN

7451.0010 € 83,-

Castors set (4x)
> 7950.0410

7451.0009 € 121,-

Castors set (6x)
> 7950.0415



REFRIGERATED COUNTER WITH GLASS COVER

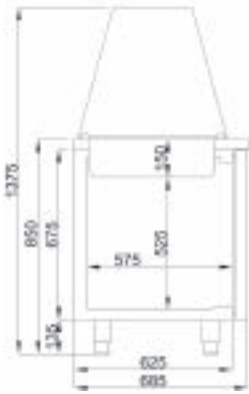

Cooking range

Drop-in

Ovens

Kitchen equipment

	7489.5150	7489.5155
	€ 3.160,-	€ 3.975,-
	1400 x 700 x 850	1865 x 700 x 850
	230 V / 0,30 kW	230 V / 0,40 kW
	-2/+8°C	-2/+8°C
	R 290	R 290
	150	180

Refrigeration

Dishwashers

Neutral

KOELWERKBANK GLASOPSTAND

- Isolatie 50mm
- Omgevingstemp. +43°C
- Vast ingebouwde compressor
- Incl. 1 rooster 1/1GN en geleiderset per deur
- Rechte glasopzet
- 3 of 4x 1/1GN inzet

KÜHLTISCH MIT GLAS

- Isolierschicht 50mm
- Umgebungstemp. +43°C
- Fest installierte Kompressor
- Einschließlich 1 Gitter 1/1GN mit Führungsschiene hinter jeden Tür
- Gerade Glasaufsatz
- 3 oder 4x 1/1GN einsatz

REFRIGERATED COUNTER WITH GLASS COVER

- Insulation 50mm
- Ambient temp. +43°C
- Permanently installed compressor
- Incl. 1 grids 1/1GN and set guides per door
- Straight glass cover
- 3 or 4x 1/1 GN insert

TABLE RÉFRIGÉRÉE AVEC VERRE

- Isolation 50mm
- Temp. ambiente +43°C
- Compresseur fixé
- 1 Grilles 1/1GN et Glissières par porte inclus
- Structure en verre droite
- 3 ou 4x 1/1 GN insert

Faucets

Ventilation

Pizzeria

7489.0506 € 65,-

Grids

7489.0905 € 90,-

Castors set (5x)

60Hz ON REQUEST

ON REQUEST

Bakery



Refrigeration

COMPACT LINE

REFRIGERATED COUNTER

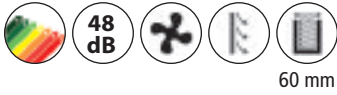

	7950.0106	7950.0108	7950.0110	7950.0112	7950.0113
	€ 885,-	€ 1.190,-	€ 1.495,-	€ 1.260,-	€ 2.180,-
	900 x 700 x 875	900 x 700 x 875	900 x 700 x 875	1365 x 700 x 875	1365 x 700 x 875
	830 x 595 x 456v	830 x 595 x 456	830 x 595 x 456	1295 x 595 x 456	1295 x 595 x 456
	230 V / 0,34 kW	230 V / 0,34 kW	230 V / 0,34 kW	230 V / 0,34 kW	230 V / 0,34 kW
	257 L	257 L	257 L	400 L	400 L
	+2/+8°C	+2/+8°C	+2/+8°C	+2/+8°C	+2/+8°C
	R 600 A	R 600 A	R 600 A	R 600 A	R 600 A
GN	2x 1/1GN	1x 1/1GN	X	3x 1/1GN	X
	82	91	99	125	150

KOELWERKBANK

- RVS uitgevoerd
- Isolatie 60mm
- Omgevingstemp. +38°C
- Statische koeler met hulp ventilator
- Digitale thermostaat
- Verstelbare roosters
- 7950.0106-0108-0112: Incl. 1 rooster 1/1GN en 1 geleiderset per deur
- 7950.0108-0110-0113: Lade 1/1GN, max. hoogte 150mm

KÜHLTISCH

- Edelstahl Ausführung
- Isolierschicht 60mm
- Umgebungstemp. +38°C
- Statische Kühlung mit Ventilator
- Digitales Thermostat
- Einstellbare Gitter austauschbar
- 7950.0106-0108-0112: Incl. 1 Gitter 1/1GN und 1 Par Führungsschienen pro Tür
- 7950.0108-0110-0113: Schublade 1/1 GN, max. Höhe 150mm

REFRIGERATED COUNTER

- Stainless steel cabinet
- Insulation 60mm
- Ambient temp. +38°C
- Static cooler, fan assisted
- Digital thermostat
- Adjustable shelves
- 7950.0106-0108-0112: Incl. 1 grid 1/1GN and 1 set of guides per door
- 7950.0108-0110-0113: Drawer 1/1 GN, Max. height 150mm

TABLE RÉFRIGÉRÉE

- Acier inoxydable
- Isolatie 60mm
- Temp. ambiente +38°C
- Froid statique, assisté par ventilateur
- Affichage numérique
- Tablettés réglables
- 7950.0106-0108-0112: Incl. 1 grille 1/1 GN et jeux de guides par porte
- 7950.0108-0110-0113: Tiroir 1/1 GN, hauteur max. 150mm

7950.5048 € 45,-

Set guides

7950.5088 € 550,-

Drawers

7450.0505 € 27,-

Grids PE COATED

GN 1/1 GN

7020.1200 € 30,-

Grids SS

GN 1/1 GN

7003.0510 € 235,-

Support

905 x 638 x 103

7003.0515 € 245,-

Support

1370 x 638 x 103



REFRIGERATED COUNTER



REFRIGERATED NEGATIVE COUNTER



	7450.0730	7450.0735
	€ 900,-	€ 1.350,-
	435 x 700 x 875	435 x 700 x 875
	365 x 595 x 456	365 x 595 x 456
	230 V / 0,12 kW	230 V / 0,12 kW
	109 L	109 L
	+2/+8°C	+2/+8°C
	R 600 A	R 600 A
	1x 1/1 GN	X
	38	46

	7450.0079
	€ 1.635,-
	943 x 700 x 855
	830 x 595 x 411
	230 V / 0,34 kW
	-10/-20°C
	R 290
GN	2x 1/1GN
	96

KOELWERKBANK

- Digitale display
- 7450.0730-0735: Statische koeler met hulp ventilator
- 7450.0079: Statische vriezer
- 7450.0730 - 7450.0079: Verstelbare roosters 1/1GN, 1x per deur
- 7450.0735: Laden capaciteit 1/1GN
- Volledig RVS
- Automatische ontdooiing
- Ronde afwerking hoeken voor makkelijk schoonmaken

KÜHLTISCH

- Digitalanzeige
- 7450.0730-0735: Statische Kühlung mit Ventilator
- 7450.0079: Statische Tiefkühlschrank
- 7450.0730 - 7450.0079: Einstellbare Gitter 1/1 GN, 1 pro Tür
- 7450.0735: Schubladen Kapazität 1/1GN
- Komplett Edelstahl
- Automatische Abtauung
- Runde Endbearbeitung Ecken für einfach sauber machen

REFRIGERATED COUNTER

- Digital display
- 7450.0730-0735: Static cooler, fan assisted
- 7450.0079: Static freezer
- 7450.0730 - 7450.0079: Adjustable shelves 1/1GN, 1 per door
- 7450.0735: Drawer capacity 1/1GN
- Completely Stainless Steel
- Automatic defrost
- Internal round edges for easy cleaning

TABLE RÉFRIGÉRÉE

- Affichage numérique
- 7450.0730-0735: Froid statique, assisté par ventilateur
- 7450.0079: Congélateur statique
- 7450.0730 - 7450.0079: Grilles Ajustables 1/1GN, 1 par porte
- 7450.0735: Capacité du tiroir 1/1GN
- Entièrement en acier inoxydable
- Dégivrage automatique
- Bords ronds internes pour un nettoyage facile

7450.0500		€ 35,-
	Set guides	
>	7450.0730	

7450.0512		€ 20,-
	Set guides	
>	7450.0079	

7450.0505		€ 27,-
	Grids PE COATED	
>	7450.0730	
GN	1/1 GN	

7020.1200		€ 30,-
	Grids SS	
>	7450.0730	
GN	1/1 GN	

7450.0507		€ 24,-
	Grids PE COATED	
>	7450.00079	
	325x570	

7003.0510		€ 235,-
	Support	
	905 x 638 x 103	

Cooking range

Drop-in

Ovens

Kitchen equipment

Refrigeration

Dishwashers

Neutral

Faucets

Ventilation

Pizzeria

Bakery



Refrigeration

STANDARD LINE

SALADETTE

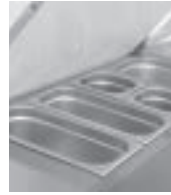
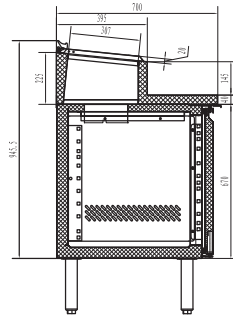

Refrigerators & Freezer Cabinets

Refrigerated & Freezer Counters

Saladettes

Coldrooms

Chest Freezers

Display Refrigeration

Ice Machines

7450.0102

€ 1.605,-



7450.0104

€ 1.835,-



	1360 x 700 x 1085	1795 x 700 x 1085
	795 x 580 x 560	1230 x 580 x 560
	230 V / 0,34 kW	230 V / 0,34 kW
	396 L	576 L
	+2/+8°C	+2/+8°C
	R 600 A	R 600 A
	145	180

SALADETTE

- Isolatie 60 mm
- Omgevingstemp. +38°C
- Vast ingebouwde compressor
- Incl. 1 rooster 1/1GN en geleiderset per deur
- RVS deksel
- 6 of 8x 1/3GN-150 inzet

SALADETTE

- Isolierschicht 60 mm
- Umgebungstemp. +38°C
- Fest installierte Kompressor
- Einschließlich 1 Gitter 1/1GN mit Führungsschiene hinter jeden Tür
- Edelstahldeckel
- 6 oder 8x 1/3GN-150 mm einatz

SALADETTE

- Insulation 60 mm
- Ambient temp. +38°C
- Permanently installed compressor
- Incl. 1 grids 1/1GN and set guides per door
- SS cover
- 6 or 8x 1/3GN-150 insert

SALADETTE

- Isolation 60 mm
- Temp. ambiente +38°C
- Compresseur fixé
- 1 Grilles 1/1GN et Glissières par porte inclus
- Couverture en acier inox
- 6 ou 8x 1/3GN-150 insert

7450.0500 € 35,-



Set guides

7450.0505 € 27,-



Grids PE COATED

GN 1/1 GN

7020.1200 € 30,-



Grids SS

GN 1/1 GN

7451.0010 € 83,-



Castors set (4x)

7451.0009 € 121,-



Castors set (6x)



SALADETTE

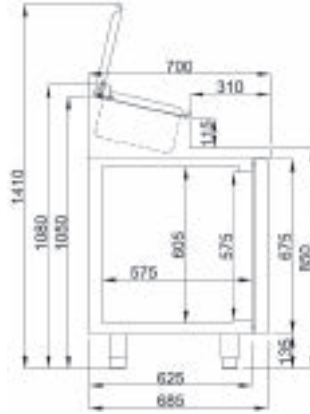

Cooking range

Drop-in

Ovens

Kitchen equipment

Refrigeration

Dishwashers

Neutral

Faucets

Ventilation

Pizzeria

Bakery

7489.5140

€ 3.065,-



7489.5145

€ 3.690,-



	1400 x 700 x 1090	1865 x 700 x 1090
	230 V / 0,30 kW	230 V / 0,35 kW
	-2/+8°C	-2/+8°C
	R 290	R 290
	155	185

SALADETTE

- Isolatie 50mm
- Omgevingstemp. +43°C
- Vast ingebouwde compressor
- Incl. 1 rooster 1/1GN en geleiderset per deur
- RVS deksel
- 7 of 10x 1/3GN-150 inzet

SALADETTE

- Isolierschicht 50mm
- Umgebungstemp. +43°C
- Fest installierte Kompressor
- Einschließlich 1 Gitter 1/1GN mit Führungsschiene hinter jeden Tür
- Edelstahldeckel
- 7 oder 10x 1/3GN-150mm einsetz

SALADETTE

- Insulation 50mm
- Ambient temp. +43°C
- Permanently installed compressor
- Incl. 1 grids 1/1GN and set guides per door
- SS cover
- 7 or 10x 1/3GN-150 insert

SALADETTE

- Isolation 50mm
- Temp. ambiente +43°C
- Compresseur fixé
- 1 Grilles 1/1GN et Glissières par porte inclus
- Couvercle en acier inox
- 7 ou 10x 1/3GN-150 insert

7489.0905 € 90,-



Castors set (5x)

60Hz ON REQUEST

ON REQUEST

7489.0506 € 65,-



Grids

7489.0525 € 515,-



Drawers

7489.0527 € 505,-



Drawer

7489.0526 € 540,-



Drawer



REFRIGERATED SALADETTE

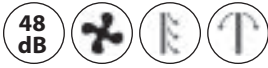

7450.0725

€ 850,-



7950.0400

€ 1.235,-



7950.0405

€ 1.420,-



WITH GLASS COVER

	435 x 700 x 875
	365 x 595 x 456
	230 V / 0,17 kW
	109 L
	+2/+8°C
	R 600 A
	1x 1/1 GN
	36

	900 x 700 x 850	1365 x 700 x 850
	230 V / 0,34 kW	230 V / 0,34 kW
	+2/+8°C	+2/+8°C
	R 600 A	R 600 A
	2x 1/1 GN 3x 1/6 GN	3x 1/1 GN 4x 1/6 GN
	90	125

GEKOELDE SALADETTE

- Digitale display
- Statische koeler met hulp ventilator
- Verstelbare roosters 1/1GN, 1x per deur
- 7450.0725: Vzv RVS deksel, in 2 delen inklapbaar
- Kunststof werkgedeelte aan voorzijde
- Volledig RVS
- Automatische ontdooing
- Excl. GN bakken en deksels

GEKÜHLTE SALADETTE

- Digitalanzeige
- Statische Kühlung mit Ventilator
- Einstellbare Gitter 1/1GN, 1 pro Tür
- 7450.0725: Edelstahl Deckel, in 2 Teilen
- Vorderseite Kunststoff Arbeitsplatte
- Komplett Edelstahl
- Automatische Abtauung
- Ohne Behälter und Deckel

REFRIGERATED SALADETTE

- Digital display
- Static cooler, fan assisted
- Adjustable shelves 1/1GN, 1 per door
- 7450.0725: With stainless steel lid, in 2 parts
- Plastic work area at the front
- Completely Stainless Steel
- Automatic defrost
- Excl. GN containers and lids

SALADETTE RÉFRIGÉRÉE

- Affichage numérique
- Froid statique, assisté par ventilateur
- Grilles Ajustables 1/1GN, 1 par porte
- 7450.0725: Avec couvercle en acier inoxydable, en 2 parties
- Zone de travail en plastique à l'avant
- Entièrement en acier inoxydable
- Dégivrage automatique
- Excl. Conteneurs et couvercles GN

7003.0510 € 235,-

	Support
	905 x 638 x 103

7003.0515 € 245,-

	Support
	1370 x 638 x 103

7450.0512 € 20,-

	Set guides
>	7450.0725

7950.5049 € 45,-

	Set guides
>	7950.0400-0405

7450.0505 € 27,-

	Grids PE COATED
>	7450.0725
	1/1 GN

7020.1200 € 30,-

	Grids SS
>	7450.0725
	1/1 GN

7450.0507 € 24,-

	Grids PE COATED
>	7950.0400 - 0405
	325x570



REFRIGERATED SALADETTE



Cooking range

Drop-in

Ovens

Kitchen equipment

Refrigeration

Dishwashers

Neutral

Faucets

Ventilation

Pizzeria

Bakery



	7950.0105	7950.0094	7950.0095	7950.0100
	€ 865,-	€ 1.220,-	€ 1.075,-	€ 1.550,-
	900 x 700 x 870	1370 x 700 x 870	903 x 700 x 1006	1368 x 700 x 1006
	830 x 590 x 456	1295 x 595 x 456	830 x 590 x 456	1295 x 595 x 456
	230 V / 0,34 kW	230V / 0,34kW	230V / 0,34kW	230V / 0,34kW
	+2/+8°C	+2/+8°C	+2/+8°C	+2/+8°C
	R 600 A	R 600 A	R 600 A	R 600 A
GN	2x 1/1 GN 2,5x 1/1 GN pan	3x 1/1 GN 4x 1/1 GN pan	2x1/1 GN 5x 1/6 GN pan	3x 1/1 GN 8x 1/6 GN pan
	90	125	72	140

GEKOELDE SALADETTE

- Digitale display
- Statische koeler met hulp ventilator
- Verstelbare roosters 1/1GN, 1x per deur
- RVS deksel
- 7950.0094-0105: Kunststof werkgedeelte aan voorzijde
- 7950.0095-0100: GN inzet opzet 5x 1/6GN of 8x 1/6GN
- Volledig RVS
- Automatische ontdooiing
- Excl. GN bakken en deksels

GEKÜHLTE SALADETTE

- Digitalanzeige
- Statische Kühlung mit Ventilator
- Einstellbare Gitter 1/1GN, 1 pro Tür
- Edelstahl Deckel
- 7950.0094-0105: Vorderseite Kunststoff Arbeitsplatte
- 7950.0095-0100: GN Setup 5x 1/6GN oder 8x 1/6GN
- Komplett Edelstahl
- Automatische Abtauung
- Ohne Behälter und Deckel

REFRIGERATED SALADETTE

- Digital display
- Static cooler, fan assisted
- Adjustable shelves 1/1GN, 1 per door
- Stainless steel lid
- 7950.0094-0105: Plastic work area at the front
- 7950.0095-0100: GN top setup 5x 1/6GN or 8x 1/6GN
- Completely Stainless Steel
- Automatic defrost
- Excl. GN containers and lids

SALADETTE RÉFRIGÉRÉE

- Affichage numérique
- Froid statique, assisté par ventilateur
- Grilles Ajustables 1/1GN, 1 par porte
- Couvercle en acier inoxydable
- 7950.0094-0105: Zone de travail en plastique à l'avant
- 7950.0095-0100: Configuration d'insertion GN 5x 1/6GN ou 8x 1/6GN
- Entièrement en acier inoxydable
- Dégivrage automatique
- Excl. Conteneurs et couvercles GN

7003.0510 € 235,-

Support

905 x 638 x 103

7003.0515 € 245,-

Support

1370 x 638 x 103

7950.5048 € 45,-

Set guides

> 7950.0095-0100

7950.5049 € 45,-

Set guides

> 7950.0094-0105

7450.0507 € 24,-

Grids PE COATED

> 7950.0105 - 0094

325x570

7020.1200 € 30,-

Grids SS

> 7950.0095 - 0100

GN 1/1 GN

7450.0505 € 27,-

Grids PE COATED

> 7950.0095 - 0100

GN 1/1 GN

COLD AND FREEZER ROOM

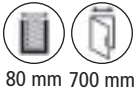

HEIGHT
2200

EXPORT
TRANSPORTKOSTEN OP AANVRAAG | TRANSPORTKOSTEN AUF ANFRAGE
TRANSPORT COSTS ON REQUEST | FRAIS DE TRANSPORT SUR DEMANDE

7489.1010	1500x1500x2200	1340x1340x2040	3,7	288	€ 3.135,-
7489.1015	1500x1800x2200	1340x1640x2040	4,5	306	€ 3.275,-
7489.1020	1500x2100x2200	1340x1940x2040	5,3	342	€ 3.535,-
7489.1035	1800x1800x2200	1640x1640x2040	5,5	336	€ 3.560,-
7489.1040	1800x2100x2200	1640x1940x2040	6,5	378	€ 3.865,-
7489.1045	1800x2400x2200	1640x2240x2040	7,5	422	€ 4.095,-
7489.1065	2100x2100x2200	1940x1940x2040	7,7	336	€ 4.180,-

7489.1070	2100x2400x2200	1940x2240x2040	8,9	378	€ 4.620,-
7489.1075	2100x2700x2200	1940x2540x2040	10,1	422	€ 4.920,-
7489.1080	2100x3000x2200	1940x2840x2040	11,2	492	€ 5.155,-
7489.1090	2400x2100x2200	2240x1940x2040	8,9	480	€ 4.630,-
7489.1095	2400x2400x2200	2240x2240x2040	10,2	547	€ 4.910,-
7489.1100	2400x2700x2200	2240x2540x2040	11,6	740	€ 5.485,-
7489.1105	2400x3000x2200	2240x2840x2040	13	750	€ 6.030,-
7489.1110	2700x1500x2200	2540x1340x2040	6,9	822	€ 4.380,-
7489.1115	2700x2100x2200	2540x1940x2040	10,1	856	€ 5.015,-
7489.1120	2700x2400x2200	2540x2240x2040	11,6	948	€ 5.565,-
7489.1125	2700x3000x2200	2540x2840x2040	14,7	1043	€ 6.410,-

KOEL/VRIESCEL

- Haaksysteem
- Excl. Motor
- RVS vloer 1mm, AISI 430
- Vriesmodel voorzien van drukklep en deurverwarming
- Deur omkeerbaar

KÜHL UND FRIERZELL

- Hakensystem
- Exklusiv Motor
- Boden aus 1mm Edelstahl AISI 430
- Tiefkühlmodell ausgestattet mit Druckventil und Türheizung
- Tür umkehrbar

COLD AND FREEZER ROOM

- Winding lock system
- Excl. motor
- SS floor 1mm, AISI 430
- Freezer model with pressure valve and door heating
- Door reversible

CHAMBRE FROIDE POSITIVE / NEGATIVE

- Système de crochet
- Exc. Moteur
- Plancher en acier inoxydable, AISI 430
- Modèle de congélation muni d'une soupape de décharge de pression et de chauffage de porte
- Porte reversible



SHELVING SYSTEM



	>			
7013.3210	7489.1010	1235/1195 x 450 x 1700	30	€ 850,-
7013.3215	7489.1015	1235/1495 x 450 x 1700	35	€ 890,-
7013.3220	7489.1020	1235/1795 x 450 x 1700	40	€ 962,-
7013.3235	7489.1035	1535/1495 x 450 x 1700	40	€ 954,-
7013.3240	7489.1040	1535/1795 x 450 x 1700	45	€ 1.026,-
7013.3245	7489.1045	1535/2095 x 450 x 1700	50	€ 1.106,-
7013.3265	7489.1065	1835/1795 x 450 x 1700	35	€ 1.098,-
7013.3270	7489.1070	1835/2095 x 450 x 1700	55	€ 1.178,-
7013.3275	7489.1075	1835/2395 x 450 x 1700	60	€ 1.242,-
7013.3280	7489.1080	1835/2690 x 450 x 1700	65	€ 1.422,-
7013.3290	7489.1090	2095/1835 x 450 x 1700	55	€ 1.178,-
7013.3295	7489.1095	2130/2095 x 450 x 1700	60	€ 1.358,-
7013.3500	7489.1100	2130/2395 x 450 x 1700	65	€ 1.422,-
7013.3305	7489.1105	2130/2690 x 450 x 1700	70	€ 1.602,-
7013.3310	7489.1110	2395/1235 x 450 x 1700	50	€ 1.106,-
7013.3315	7489.1115	2395/1235 x 450 x 1700	60	€ 1.242,-
7013.3320	7489.1120	2395/2130 x 450 x 1700	65	€ 1.422,-
7013.3325	7489.1125	2395/2280 x 450 x 1700	75	€ 1.462,-

CURTAINS FOR COLD AND FREEZER

7059.0005

€ 240,-

- Strokgordijn tbv cel
- Vorhang für Kühl-Frierzell
- Curtains for cold and freezer room
- Pour chambre froide positive / negative

	>1050 x >2000
	45

VENTING BEAMS FOR FREEZER ROOM

7469.1645

€ 80,-

- Ontluchtungs balken tbv vriescel
- Bodenunterlüftungs balken für Frierzell
- Venting beams for freezer room
- Barres de ventilation pour chambre froide negative

	8x 2000 x 42 x 42 mm		X
--	----------------------	--	---

Cooking range

Drop-in

Ovens

Kitchen equipment

Refrigeration

Dishwashers

Neutral

Faucets

Ventilation

Pizzeria

Bakery

COLD AND FREEZER ROOM

 KOEL/VRIESCEL











 KÜHL UND FRIERZELL

 COLD AND FREEZER ROOM

 CHAMBRE FROIDE POSITIVE/NEGATIVE









HEIGHT
2010

						
7489.0005	1200x1500x2010	1040x1340x1850	2,6	580	180	€ 2.330,- 
7489.0015	1500x1800 x2010	1340 x1640x1850	4	700	190	€ 2.945,- 
7489.0025	1500x2400 x2010	1340x2240x1850	5,5	700	250	€ 3.425,- 
7489.0035	1800x1800x2010	1640x1640x1850	5	700	260	€ 3.205,- 
7489.0040	1800x2100x2010	1640x1940x1850	5,9	700	280	€ 3.480,- 

EXPORT

TRANSPORTKOSTEN OP AANVRAAG | TRANSPORTKOSTEN AUF ANFRAGE
TRANSPORT COSTS ON REQUEST | FRAIS DE TRANSPORT SUR DEMANDE

						
7489.0060	1800x3000x2010	1640x2840x1850	8,5	700	320	€ 4.370,- 
7489.0070	2100x2100x2010	1940x1940x1850	6,9	700	280	€ 3.765,- 



SHELVING SYSTEM



	>			
7013.3005	7489.0005	935/1195 x 450 x 1700	25	€ 778,-
7013.3015	7489.0015	1235/1495 x 450 x 1700	35	€ 890,-
7013.3025	7489.0025	1235/2095 x 450 x 1700	45	€ 1.042,-
7013.3035	7489.0035	1535/1495 x 450 x 1700	40	€ 954,-
7013.3040	7489.0040	1535/1795 x 450 x 1700	45	€ 1.026,-
7013.3060	7489.0060	1535/2690 x 450 x 1700	60	€ 1.350,-
7013.3070	7489.0070	1835/1795 x 450 x 1700	50	€ 1.098,-

CURTAINS FOR COLD AND FREEZER

7059.0005

€ 240,-

- Strokgordijn tbv cel
- Vorhang für Kühl-Frierzell
- Curtains for cold and freezer room
- Pour chambre froide positive / negative

		>1050 x >2000
		45

VENTING BEAMS FOR FREEZER ROOM

7469.1645

€ 80,-

- Ontluchttingsbalken tbv vriescel
- Bodenunterlüftungs balken für Frierzell
- Venting beams for freezer room
- Barres de ventilation pour chambre froide negative

	8x 2000 x 42 x 42 mm		X
--	----------------------	--	---

Cooking range

Drop-in

Ovens

Kitchen equipment

Refrigeration

Dishwashers

Neutral

Faucets

Ventilation

Pizzeria

Bakery

COLD AND FREEZER ROOM

KOEL/VRIESCEL

KÜHL UND FRIERZELL

COLD AND FREEZER ROOM

CHAMBRE FROIDE POSITIVE/NEGATIVE

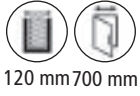

120 mm 700 mm



Refrigerators & Freezer Cabinets

Refrigerated & Freezer Counters

Saladettes

Coldrooms

Chest Freezers

Display Refrigeration

Ice Machines

HEIGHT
2200

7489.2010	1500x1500x2200	1260x1260x1960	3,1	320	€ 3.650,-
7489.2015	1500x1800x2200	1260x1560x1960	3,9	350	€ 3.810,-

EXPORT

TRANSPORTKOSTEN OP AANVRAAG | TRANSPORTKOSTEN AUF ANFRAGE
TRANSPORT COSTS ON REQUEST | FRAIS DE TRANSPORT SUR DEMANDE

7489.2020	1500x2100x2200	1260x1860x1960	4,6	380	€ 4.105,-
7489.2035	1800x1800x2200	1560x1560x1960	4,8	380	€ 4.415,-
7489.2040	1800x2100x2200	1560x1860x1960	5,7	400	€ 4.620,-
7489.2045	1800x2400x2200	1560x2160x1960	6,6	420	€ 4.895,-
7489.2065	2100x2100x2200	1860x1860x1960	6,8	420	€ 4.885,-
7489.2070	2100x2400x2200	1860x2160x1960	7,9	450	€ 5.495,-
7489.2075	2100x2700x2200	1860x2460x1960	9	505	€ 5.845,-
7489.2080	2100x3000x2200	1860x2760x1960	10,1	525	€ 6.130,-
7489.2090	2400x2100x2200	2160x1860x1960	7,9	450	€ 5.520,-
7489.2095	2400x2400x2200	2160x2160x1960	9,7	505	€ 5.835,-
7489.2100	2400x2700x2200	2160x2460x1960	10,4	525	€ 6.510,-
7489.2105	2400x3000x2200	2160x2760x1960	11,7	545	€ 6.995,-
7489.2115	2700x1500x2200	2460x1260x1960	6,1	420	€ 5.220,-
7489.2120	2700x2100x2200	2460x1860x1960	9	505	€ 5.965,-
7489.2125	2700x2400x2200	2460x2160x1960	10,4	525	€ 6.605,-
7489.2130	2700x3000x2200	2460x2760x1960	13,3	570	€ 7.445,-



SHELVING SYSTEM

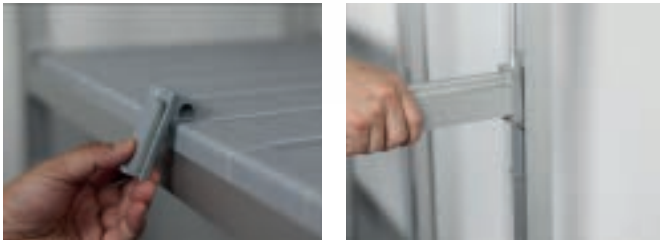

Cooking range

Drop-in

Ovens

Kitchen equipment

Refrigeration

Dishwashers

Neutral

Faucets

Ventilation

Pizzeria

Bakery

	>			
7013.3710	7489.2010	1235/1195 x 450 x 1700	30	€ 850,-
7013.3715	7489.2015	1235/1495 x 450 x 1700	35	€ 890,-
7013.3720	7489.2020	1235/1795 x 450 x 1700	40	€ 962,-
7013.3735	7489.2035	1535/1495 x 450 x 1700	40	€ 954,-
7013.3740	7489.2040	1535/1795 x 450 x 1700	45	€ 1.026,-
7013.3745	7489.2045	1535/2095 x 450 x 1700	50	€ 1.106,-
7013.3765	7489.2065	1835/1795 x 450 x 1700	35	€ 1.098,-
7013.3770	7489.2070	1835/2095 x 450 x 1700	55	€ 1.178,-
7013.3775	7489.2075	1835/2395 x 450 x 1700	60	€ 1.242,-
7013.3780	7489.2080	1835/2540 x 450 x 1700	65	€ 1.390,-
7013.3790	7489.2090	2130/1795 x 450 x 1700	55	€ 1.286,-
7013.3795	7489.2095	2130/2095 x 450 x 1700	60	€ 1.366,-
7013.3800	7489.2100	2130/2395 x 450 x 1700	65	€ 1.430,-
7013.3805	7489.2105	2130/2540 x 450 x 1700	70	€ 1.026,-
7013.3815	7489.2115	2395/1235 x 450 x 1700	50	€ 1.106,-
7013.3820	7489.2120	2395/1835 x 450 x 1700	60	€ 1.242,-
7013.3825	7489.2125	2395/2130 x 450 x 1700	65	€ 1.430,-
7489.3830	7489.2130	2430/2540 x 450 x 1700	75	€ 1.650,-

CURTAINS FOR COLD AND FREEZER

7059.0005

€ 240,-

- Strokgordijn tbv cel
- Vorhang für Kühl-Frierzell
- Curtains for cold and freezer room
- Pour chambre froide positive / negative

		>1050 x >2000
		45

VENTING BEAMS FOR FREEZER ROOM

7469.1645

€ 80,-

- Ontluchttingsbalken tbv vriescel
- Bodenunterlüftungs balken für Frierzell
- Venting beams for freezer room
- Barres de ventilation pour chambre froide negative

	8x 2000 x 42 x 42 mm		X
--	----------------------	--	---

COLD AND FREEZER ROOM

 KOEL/VRIESCEL

 KÜHL UND FRIERZELL

 COLD AND FREEZER ROOM

 CHAMBRE FROIDE POSITIVE/NEGATIVE













120 mm 700 mm



HEIGHT
2400

EXPORT

TRANSPORTKOSTEN OP AANVRAAG | TRANSPORTKOSTEN AUF ANFRAGE
TRANSPORT COSTS ON REQUEST | FRAIS DE TRANSPORT SUR DEMANDE

					
7489.2200	2400 x 3600 x 2400	2160 x 3360 x 2160	15,6	656	€10.375,- 
7489.2205	3000 x 3000 x 2400	2760 x 2760 x 2160	16,4	684	€ 8.780,- 
7489.2210	2400 x 4200 x 2400	2160 x 3960 x 2160	18,	738	€11.815,- 
7489.2215	3000 x 3600 x 2400	2760 x 3360 x 2160	20	821	€12.770,- 
7489.2220	3000 x 4200 x 2400	2760 x 3960 x 2160	23,6	958	€14.685,- 
7489.2225	3000 x 5400 x 2400	2760 x 5160 x 2160	30,7	1231	€17.240,- 



SHELVING SYSTEM



	>			
7013.3405	7489.2200	2245/3330 x 450 x 1700	85	€ 1.670,-
7013.3410	7489.2205	2430/2730 x 450 x 1700	80	€ 1.810,-
7013.3415	7489.2210	2245/3930 x 450 x 1700	90	€ 1.814,-
7013.3420	7489.2215	2840/3330 x 450 x 1700	95	€ 1.922,-
7013.3425	7489.2220	2840/3930 x 450 x 1700	100	€ 2.066,-
7013.3430	7489.2225	2840/5125 x 450 x 1700	105	€ 2.462,-

CURTAINS FOR COLD AND FREEZER

7059.0005

€ 240,-

- Strokgordijn tbv cel
- Vorhang für Kühl-Frierzell
- Curtains for cold and freezer room
- Pour chambre froide positive / negative

		>1050 x >2000
		45

VENTING BEAMS FOR FREEZER ROOM

7469.1645

€ 80,-

- Ontluchttingsbalken tbv vriescel
- Bodenunterlüftungs balken für Frierzell
- Venting beams for freezer room
- Barres de ventilation pour chambre froide negative

	8x 2000 x 42 x 42 mm		X
--	----------------------	--	---

Cooking range

Drop-in

Ovens

Kitchen equipment

Refrigeration

Dishwashers

Neutral

Faucets

Ventilation

Pizzeria

Bakery

MINI COLD ROOM

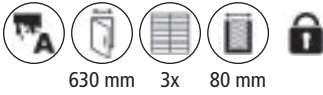

7489.0300

€ 4.065,-

MINI COLD ROOM

	1000 x 1000 x 2340
	840 x 840 x 1850
	1,59
	230 V / 0,85 kW
	-2/+8°C
	R 290
	230

MINI KOELCEL
INCL. KOELUNIT

- Koelsysteem met verdampfer
- Omkeerbare deur
- Automatische ontdooiing
- Deur te openen vanaf binnenzijde
- Dikte panelen 80 mm
- Cel voorzien van geleiders, plaats voor 5 roosters, waarvan 3 inclusief
- Omgevingstemperatuur +32°C

MINI KÜHLZELL
INKL. KÜHLAGGREGAT

- Kühlsystem mit Verdampfer
- Tür umkehrbar
- Automatische Abtauung
- Tür öffnet sich von Innen
- Panelen 80 mm
- Kühlzelle mit Führungsschienen, platz für 5 Gitter, davon 3 Stück inklusiv
- Umgebungstemperatur +32°C

MINI COLD ROOM
INCL. POSITIVE UNIT

- Refrigerating unit with evaporation system
- Reversible door
- Automatic defrost
- Door can be opened from the inside
- Panel thickness 80 mm
- Room provided with guides, space for 5 shelves, 3 of which are included
- Ambient temperature +32°C

MINI CHAMBRE FROID
INCL. UNITÉ TYPE POSITIF

- Groupe frigorifique avec système d'évaporation
- Porte réversible
- Dégivrage automatique
- La porte peut être ouverte de l'intérieur
- Épaisseur du panneau 80 mm
- Chambre avec guides, espace pour 5 grilles, dont 3 inclus
- Temp. ambiente +32°C

7489.0310 € 20,-



Grids

7489.0315 € 10,-



Set clips for grid 4x



MINI FREEZER ROOM



630 mm 3x 80 mm



Cooking range

Drop-in

Ovens

Kitchen equipment

Refrigeration

Dishwashers

Neutral

Faucets

Ventilation

Pizzeria

Bakery

7489.0305

€ 5.160,-



MINI FREEZER ROOM

	1000 x 1000 x 2340
	840 x 840 x 1850
	1,59
	230 V / 1,1 kW
	-10 / -22°C
	R 290
	245

MINI VRIESCEL

INCL. VRIESUNIT

- Vriessysteem met verdamper
- Omkeerbare deur
- Automatische ontdooiing
- Deur te openen vanaf binnenzijde
- Dikte panelen 80 mm
- Cel voorzien van geleiders, plaats voor 5 roosters, waarvan 3 inclusief
- Omgevingstemperatuur +32°C

MINI FRIERZELL

INKL. TIEFKÜHLAGGREGATE

- Tiefkühlsystem mit Verdampfer
- Tür umkehrbar
- Automatische Abtauung
- Tür öffnet sich von Innen
- Panelen 80 mm
- Kühlzelle mit Führungsschienen, platz für 5 Gitter, davon 3 Stück inklusiv
- Umgebungstemperatur +32°C

MINI FREEZER ROOM

INCL. NEGATIVE UNIT

- Freezing unit with evaporation system
- Reversible door
- Automatic defrost
- Door can be opened from the inside
- Panel thickness 80 mm
- Room provided with guides, space for 5 shelves, 3 of which are included
- Ambient temperature +32°C

MINI CHAMBRE FRIGORIFIQUES

INCL. UNITÉ TYPE NÉGATIF

- Unité de congélation avec système d'évaporation
- Porte réversible
- Dégivrage automatique
- La porte peut être ouverte de l'intérieur
- Épaisseur du panneau 80 mm
- Chambre avec guides, espace pour 5 grilles, dont 3 inclus
- Temp. ambiente +32°C

7489.0310 € 20,-



Grids

7489.0315 € 10,-



Set clips for grid 4x

POSITIVE STRADDLE-TYPE UNIT











 INHANGUNIT KOEL

 KÜHLAGGREGAT HUCKEPACK

 POSITIVE STRADDLE-TYPE UNIT

 UNITÉ DE RÉFROIDISSEMENT TYPE POSITIF



	7489.0400	7489.0405	7489.0410	7489.0415	7489.0420
	€ 1.970,-	€ 1.998,-	€ 2.220,-	€ 2.390,-	€ 2.640,-
					
	450 x 875 x 770	450 x 875 x 770	450 x 875 x 770	600 x 965 x 770	600 x 965 x 770
	230 V / 0,73 kW	230 V / 0,73 kW	230 V / 0,78 kW	230 V / 0,78 kW	230 V / 0,88 kW
	0/+8°C	0/+8°C	0/+8°C	0/+8°C	0/+8°C
	R 452 A	R 452 A	R 452 A	R 452 A	R 452 A
	75	80	90	96	110



INHANGUNIT VRIES

TIEFKÜHLAGGREGAT HUCKEPACK

NEGATIVE STRADDLE-TYPE UNIT

UNITÉ DE RÉFROIDISSEMENT TYPE NÉGATIF

NEGATIVE STRADDLE-TYPE UNIT



Cooking range

Drop-in

Ovens

Kitchen equipment

Refrigeration

Dishwashers

Neutral

Faucets

Ventilation

Pizzeria

Bakery

	7489.0430	7489.0435	7489.0440	7489.0445
	€ 2.780,-	€ 3.390,-	€ 3.480,-	€ 4.450,-
	450 x 925 x 770	600 x 965 x 770	600 x 965 x 770	600 x 965 x 770
	230 V / 0,88 kW	400 V / 0,77 kW	400 V / 0,77 kW	400 V / 0,85 kW
	-0/-20°C	-0/-20°C	-0/-20°C	-0/-20°C
	R 452 A	R 452 A	R 452 A	R 452 A
	105	115	115	120

Refrigerators & Freezer Cabinets

Refrigerated & Freezer Counters

Saladettes

Coldrooms

Chest Freezers

Display Refrigeration

Ice Machines

POSITIVE STRADDLE-TYPE UNIT

 INHANGUNIT KOEL

 KÜHLAGGREGAT HUCKEPACK

 POSITIVE STRADDLE-TYPE UNIT

 UNITÉ DE RÉFROIDISSEMENT TYPE POSITIF



7265.0005	7265.0010	7265.0015	7265.0020
€ 3.065,-	€ 3.430,-	€ 4.235,-	€ 4.385,-

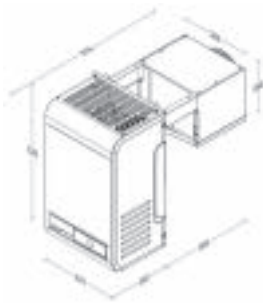

	421 x 876 x 728	421 x 876 x 728	671 x 975 x 828	671 x 975 x 828
	230 V / 0,54 kW	230 V / 0,78 kW	230 V / 0,99 kW	230 V / 1,2 kW
	-5/+10°C	-5/+10°C	-5/+10°C	-5/+10°C
	R 290	R 290	R 290	R 290
	58	60	88	89



INHANGUNIT VRIESER

TIEFKÜHLAGGREGAT HUCKEPACK

NEGATIVE STRADDLE-TYPE UNIT

UNITÉ DE RÉFROIDISSEMENT TYPE NÉGATIF

NEGATIVE STRADDLE-TYPE UNIT



Cooking range

Drop-in

Ovens

Kitchen equipment

Refrigeration

Dishwashers

Neutral

Faucets

Ventilation

Pizzeria

Bakery

	7265.0070	7265.0075	7265.0085
	€ 3.820,-	€ 4.115,-	€ 4.925,-
	421 x 876 x 728	671 x 965 x 770	671 x 965 x 770
	230 V / 0,91 kW	230 V / 0,94 kW	230 V / 1,3 kW
	-25/-15°C	-25/-15°C	-25/-15°C
	R 290	R 290	R 290
	68	89	118

POSITIVE STRADDLE-TYPE UNIT

INHANGUNIT KOEL

KÜHLAGGREGAT HUCKEPACK

POSITIVE STRADDLE-TYPE UNIT

UNITÉ DE RÉFROIDISSEMENT TYPE POSTIF

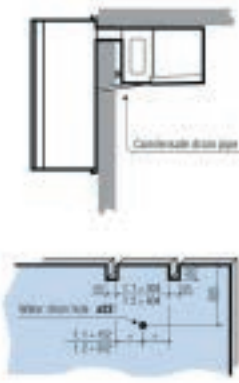

	7492.0003	7492.0005	7492.0010	7492.0015	7492.0017	7492.0020
	€ 2.195,-	€ 2.415,-	€ 2.645,-	€ 3.170,-	€ 3.610,-	€ 4.770,-
	485 x 835 x 767	485 x 835 x 767	485 x 835 x 767	785 x 835 x 767	785 x 835 x 767	770 x 835 x 767
	230 V / 0,71 kW	230 V / 0,92 kW	230 V / 1,16 kW	230 V / 1,47 kW	230 V / 1,58 kW	400 V / 2,06 kW
	0/+5°C	0/+5°C	0/+5°C	0/+5°C	0/+5°C	0/+5°C
	R 452 A	R 452 A	R 452 A	R 452 A	R 452 A	R 452 A
	49	49	55	73	74	92

Potenza frigorifera • Refrigerating capacity (W) - Volume cella • Room volume m³

Temperatura cella • Cold room temperatura



+5°C

0°C

-5°C

Temperatura estern • Ambient temperatura



+20°C

+32°C

+43°C

+20°C

+32°C

+43°C

+20°C

+32°C

+ 43°C

	+20°C		+32°C		+43°C		+20°C		+32°C		+43°C		+20°C		+32°C		+ 43°C	
	W	m ³	W	m ³	W	m ³	W	m ³	W	m ³	W	m ³	W	m ³	W	m ³	W	m ³
7492.0003	1340	16,5	1025	12,2	765	6,6	1105	12,5	830	7,7	615	4	960	9,1	670	5,3	480	3
7492.0005	1565	20,5	1215	15,5	960	8,5	1290	15,5	985	10,4	775	6	1065	10,7	800	7,8	625	4,3
7492.0010	1965	28,1	1520	19,3	1205	11,4	1620	20	1240	14,1	975	8,2	1335	13,5	1000	8,8	785	5,9
7492.0015	2560	30,9	1990	22,5	1490	14,5	2040	21,8	1555	16,1	1205	9,9	1680	15,8	1260	10,5	970	7,1
7492.0017	3055	35,6	2375	28,1	1810	19,3	2435	25,4	1860	19,3	1470	14,2	2005	19	1505	14	1190	11,3
7492.0020	4462	78,8	3468	61,5	2550	34,1	3554	54,7	2713	40,4	2065	23,2	2927	39,3	2198	28	1662	16,2



INHANGUNIT VRIES

TIEFKÜHLAGGREGAT HUCKEPACK

NEGATIVE STRADDLE-TYPE UNIT

UNITÉ DE RÉFROIDISSEMENT TYPE NÉGATIF

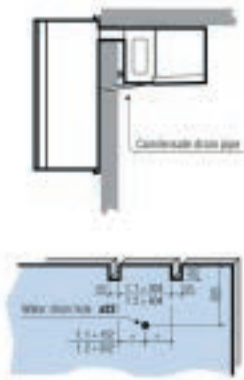

Cooking range

Drop-in

Ovens

Kitchen equipment

Refrigeration

Dishwashers

Neutral

Faucets

Ventilation

Pizzeria

Bakery

7492.0024	7492.0025	7492.0029	7492.0030	7492.0035
€ 3.700,-	€ 4.015,-	€ 4.585,-	€ 4.165,-	€ 4.985,-

	7492.0024	7492.0025	7492.0029	7492.0030	7492.0035
	785 x 835 x 767	785 x 835 x 767	785 x 835 x 767	785 x 835 x 767	770 x 1070 x 860
	230 V / 1,46 kW	230 V / 1,81 kW	230 V / 2,53 kW	400 V / 2,47 kW	400 V / 2,47 kW
	-10/-20°C	-10/-20°C	-10/-20°C	-10/-20°C	-10/-20°C
	R 452 A	R 452 A	R 452 A	R 452 A	R 452 A
	78	89	88	88	115

Potenza frigorifera • Refrigerating capacity (W) - Volume cella • Room volume m ³												
Temperatura cella • Cold room temperatura												
-18 °C						-22 °C						
Temperatura esterna • Ambient temperatura												
	+20°C		+32°C		+43°C		+20°C		+32°C		+43°C	
	W	m ³	W	m ³	W	m ³	W	m ³	W	m ³	W	m ³
7492.0024	1400	16,4	1015	10	755	7,1	1110	11,7	800	7	575	4,8
7492.0025	1870	23,1	1365	13,7	920	9,1	1540	17,7	1090	9,8	700	6,3
7492.0029	2650	35,3	1990	21,4	1500	16	2180	26,8	1590	15,6	1175	11,1
7492.0030	2650	35,3	1990	21,4	1500	16	2180	26,8	1590	15,6	1175	11,1
7492.0035	2920	38,9	2281	24,5	1663	17,7	2472	30,3	1838	18	1302	12,36

POSITIVE WALL-MOUNTED UNIT

INSTEKUNIT KOEL

KÜHLAGGREGAT HUCKEPACK

POSITIVE WALL-MOUNTED UNIT

UNITÉ DE RÉFROIDISSEMENT TYPE POSTIF



	7492.0080	7492.0085	7492.0090	7492.0095
	€ 2.780,-	€ 2.955,-	€ 3.550,-	€ 5.465,-
	485 x 831 x 767	485 x 831 x 767	785 x 831 x 767	770 x 1070 x 860
	230 V / 0,92 kW	230 V / 1,16 kW	230 V / 1,47 kW	400 V / 2,06 kW
	0/+5°C	0/+5°C	0/+5°C	0/+5°C
	R 452 A	R 452 A	R 452 A	R 452 A
	52	58	79	95

Potenza frigorifera • Refrigerating capacity (W) - Volume cella • Room volume m ³																											
Temperatura cella • Cold room temperatura																											
+5°C					0°C					-5°C																	
Temperatura estern • Ambient temperatura																											
+20°C				+32°C				+43°C				+20°C				+32°C				+43°C							
W		m ³		W		m ³		W		m ³		W		m ³		W		m ³		W		m ³		W		m ³	
7492.0080	1565	20,5	1215	15,5	960	8,5	1290	15,5	985	10,4	775	6	1065	10,7	800	7,8	625	4,3									
7492.0085	2025	26,5	1570	20	1240	11	1670	20,1	1275	13,4	1005	7,8	1375	13,8	1035	10	810	5,5									
7492.0090	2560	30,9	1990	22,5	1490	14,5	2040	21,8	1555	16,1	1205	9,9	1680	15,8	1260	10,5	970	7,1									
7492.0095	4462	78,8	3468	61,5	2550	34,1	3554	54,7	2713	40,4	2065	23,2	2927	39,3	2198	28	1662	16,2									



INSTEELUNIT VRIES

TIEFKÜHLAGGREGAT HUCKEPACK

NEGATIVE WALL-MOUNTED UNIT

UNITÉ DE RÉFROIDISSEMENT TYPE NÉGATIF

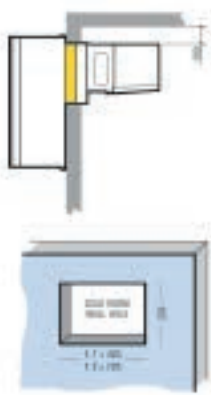

Cooking range

Drop-in

Ovens

Kitchen equipment

	7492.0100	7492.0105	7492.0110	7492.0115
	€ 3.980,-	€ 4.390,-	€ 4.640,-	€ 5.975,-
	785 x 831 x 767	785 x 831 x 767	785 x 831 x 767	770 x 1070 x 860
	230 V / 1,46 kW	400 V / 1,81 kW	400 V / 2,63 kW	400 V / 2,47 kW
	-10/-20°C	-10/-20°C	-10/-20°C	-10/-20°C
	R 452 A	R 452 A	R 452 A	R 452 A
	84	86	86	118

Refrigeration

Dishwashers

Neutral

Faucets

Potenza frigorifera • Refrigerating capacity (W) - Volume cella • Room volume m ³													
	Temperatura cella • Cold room temperatura												
	-18°C						-22°C						
	Temperatura esterna • Ambient temperatura												
	+20°C		+32°C		+43°C		+20°C		+32°C		+43 C		
	W	m ³	W	m ³	W	m ³	W	m ³	W	m ³	W	m ³	
7492.0100	1400	16,4	1015	10	755	7,1	1110	11,7	800	7	575	4,8	
7492.0105	1870	23,1	1365	13,7	920	9,1	1540	17,7	1090	9,8	700	6,3	
7492.0110	2650	35,3	1990	21,4	1500	16	2180	26,8	1590	15,6	1175	11,1	
7492.0115	2920	38,9	2281	24,5	1663	17,7	2472	30,3	1838	18	1302	12,36	

Ventilation

Pizzeria

Bakery



Refrigeration

Refrigerators & Freezer Cabinets

Refrigerated & Freezer Counters

Saladettes

Coldrooms

Chest Freezers

Display Refrigeration

Ice Machines

POSITIVE SPLIT UNIT

SPLIT UNIT KOEL

KÜHLAGGREGAT SPLIT

POSITIVE SPLIT UNIT

UNITÉ RÉFROIDISSEMENT SPLIT POSITIF



7480.0005

€ 3.765,-



7480.0010

€ 4.020,-

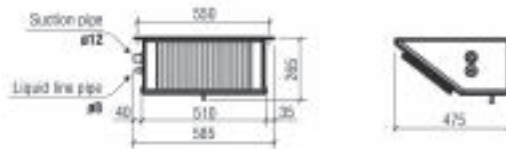
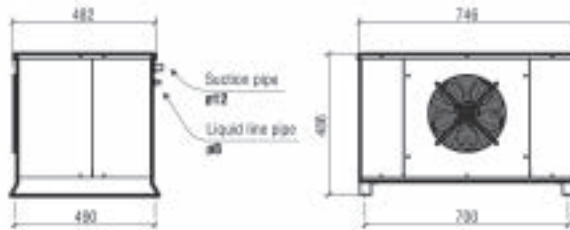

	230 V / 0,74 W	230 V / 1,19 kW
	0/+5°C	0/+5°C
	50	53

Potenza frigorifera • Refrigerating capacity (W) - Volume cella • Room volume m³

Temperatura cella • Cold room temperatura

+5°C

0°C

-5°C

Temperatura estern • Ambient temperatura

+25°C

+32°C

+43°C

+25°C

+32°C

+43°C

+25°C

+32°C

+43°C

W

m³

W

m³

W

m³

W

m³

W

m³

W

m³

W

m³

W

m³

W

m³

W

m³

W

m³

	+25°C		+32°C		+43°C		+25°C		+32°C		+43°C		+25°C		+32°C		+43°C	
	W	m ³	W	m ³	W	m ³	W	m ³	W	m ³	W	m ³	W	m ³	W	m ³	W	m ³
7480.0005	1269	24,49	1155	15,43	968	5,59	1090	15,27	986	9,72	812	3,52	937	9,79	843	6,26	691	2,31
7480.0010	1825	40,21	1674	26,17	1388	9,81	1528	25,18	1434	16,87	1300	7,48	1321	16,51	1224	11,05	1087	4,86
7480.0015	2717	71,95	2458	47,29	2056	18,97	2273	45,51	2054	29,91	1773	12,76	1922	29,53	1740	19,53	1514	8,59
7480.0040	3057	83,97	2768	55,84	2274	22,1	2568	53,42	2315	35,42	1912	14,35	2177	34,92	1957	23,23	1613	9,49
7480.0045	4562	96,37	4141	73,32	3434	48,32	3894	66,26	3505	53,11	2874	32,62	3283	46,21	2959	40,14	2422	25,85



7480.0015

7480.0040

7480.0045

€ 4.880,-

€ 5.015,-

€ 6.000,-

	7480.0015	7480.0040	7480.0045
	230 V / 1,5 kW	230 V / 1,58 kW	400 V / 2,26 kW
	0/+5°C	0/+5°C	0/+5°C
	78	78	101

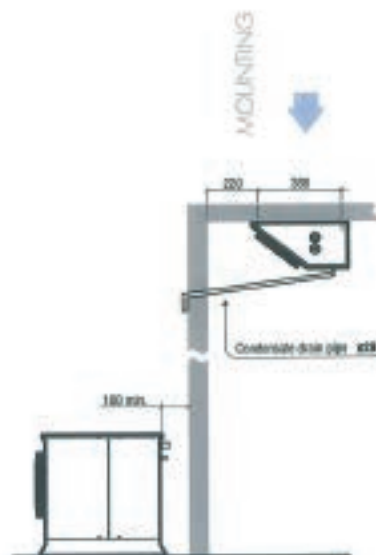



Refrigeration

Refrigerators & Freezer Cabinets

Refrigerated & Freezer Counters

Saladettes

Coldrooms

Chest Freezers

Display Refrigeration

Ice Machines

NEGATIVE SPLIT UNIT

SPLIT UNIT VRIES

TIEF-KÜHLAGGREGAT SPLIT

NEGATIVE SPLIT UNIT

UNITÉ RÉFROIDISSEMENT SPLIT TYPE NÉGATIF



7480.0020

€ 4.295,-

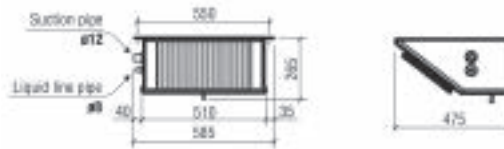
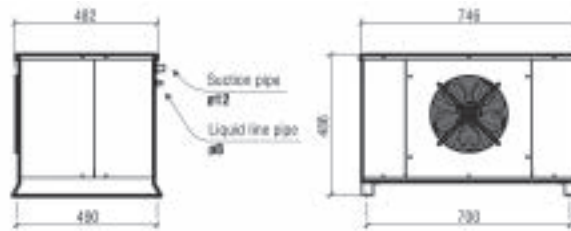

230 V / 1,38 kW



-18/-22°C



71

Potenza frigorifera • Refrigerating capacity (W) - Volume cella • Room volume m³

Temperatura cella • Cold room temperatura

-18°C

-22°C

Temperatura esterna • Ambient temperatura

+25°C

+32°C

+43°C

+25°C

+32°C

+43 C

W

m³

W

m³

W

m³

W

m³

W

m³

W

m³

7480.0020

1164

11,28

1028

7,41

791

2,66

1013

8,1

882

5,21

686

1,92

7480.0025

1603

19,21

1392

12,41

1065

4,52

1399

13,79

1194

8,74

887

3,05

7480.0030

1885

24,59

1646

16,07

1276

6,09

1588

16,83

1378

10,94

1050

4,04

7480.0055

2297

31,69

2026

23,81

1612

13,33

1982

25,05

1733

18,52

1360

9,41

7480.0060

2618

36,22

2348

27,54

1910

15,88

2223

26,18

1980

21,17

1586

10,88



	7480.0025	7480.0030	7480.0055	7480.0060
	€ 5.020,-	€ 5.355,-	€ 6.035,-	€ 6.000,-
	230 V / 1,48 kW	400 V / 1,78 kW	400 V / 2,72 kW	400 V / 2,68 kW
	-18/-22°C	-18/-22°C	-18/-22°C	-18/-22°C
	79	81	109	111





Refrigeration

Refrigerators & Freezer Cabinets

Refrigerated & Freezer Counters

Saladettes

Coldrooms

Chest Freezers

Display Refrigeration

Ice Machines

POSITIVE STRADDLE-TYPE UNIT SLIM

INHANGUNIT KOEL SMAL

KÜHLAGGREGAT HUCKEPACK SCHMAL

POSITIVE STRADDLE-TYPE UNIT SLIM

UNITÉ DE RÉFROIDISSEMENT TYPE POSTIF SMALL



7492.0060	7492.0065	7492.0070
€ 2.480,-	€ 2.545,-	€ 2.750,-

	400 x 835 x 767	400 x 835 x 767	400 x 835 x 767
	230 V / 0,68 kW	230 V / 0,92 kW	230 V / 1,16 kW
	0/+5°C	0/+5°C	0/+5°C
	R 452 A	R 452 A	R 452 A
	46	47	52

Potenza frigorifera • Refrigerating capacity (W) - Volume cella • Room volume m³

Temperatura cella • Cold room temperatura



+5°C

0°C

-5°C

Temperatura estern • Ambient temperatura



+20°C

+32°C

+43°C

+20°C

+32°C

+43°C

+20°C

+32°C

+ 43°C

W

m³

W

m³

W

m³

W

m³

W

m³

W

m³

W

m³

W

m³

W

m³

W

m³

W

m³

	+20°C		+32°C		+43°C		+20°C		+32°C		+43°C		+20°C		+32°C		+ 43°C	
7492.0060	1005	12,4	770	9,2	580	5	830	9,4	625	5,8	465	2,8	685	6,5	505	4	370	2,2
7492.0065	1565	20,5	1215	15,5	960	8,5	1290	15,5	985	10,4	775	6	1065	10,7	800	7,8	625	4,3
7492.0070	1965	28,1	1520	19,3	1205	11,4	1620	20	1240	14,1	975	8,2	1335	13,5	1000	8,8	785	5,9



NEGATIVE STRADDLE-TYPE UNIT SLIM

INHANGUNIT VRIES SMAL

TIEFKÜHLAGGREGAT HUCKEPACK SCHMAL

NEGATIVE STRADDLE-TYPE UNIT SLIM

UNITÉ DE RÉFROIDISSEMENT TYPE NÉGATIF SMALL

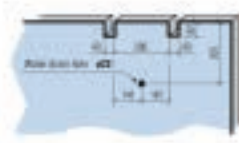

Cooking range

Drop-in

Ovens

Kitchen equipment

7492.0075

€ 3.230,-



	400 x 835 x 767
	230 V / 1,35 kW
	-18/-25°C
	R 452 A
	56

Refrigeration

Dishwashers

Neutral

Faucets

Potenza frigorifera • Refrigerating capacity (W) - Volume cella • Room volume m³

Temperatura cella • Cold room temperatura

-18 °C

-22 °C

Temperatura esterna • Ambient temperatura

+25°C

+32°C

+43°C

+25°C

+32°C

+43°C

W

m³

W

m³

W

m³

W

m³

W

m³

W

m³

7492.0075

1150

12,5

815

7,1

620

5,5

935

10,2

635

4,7

470

3,5

Ventilation

Pizzeria

Bakery



Refrigeration

Refrigerators & Freezer Cabinets

Refrigerated & Freezer Counters

Saladettes

Coldrooms

Chest Freezers

Display Refrigeration

Ice Machines

POSITIVE WALL-MOUNTED UNIT SLIM

INSTEKUNIT KOEL SMAL

KÜHLAGGREGAT HUCKEPACK SCHMAL

KÜHLAGGREGATE HUCKEPACK SLIM

UNITÉ DE RÉFROIDISSEMENT TYPE POSITIF SMALL



7492.0120

7492.0125

7492.0130

€ 2.590,-

€ 2.760,-

€ 2.940,-



	400 x 831 x 767	400 x 831 x 767	400 x 831 x 767
	230 V / 0,66 kW	230 V / 0,92 kW	230 V / 1,16 kW
	0/+5°C	0/+5°C	0/+5°C
	R 452 A	R 452 A	R 452 A
	49	50	56

Potenza frigorifera • Refrigerating capacity (W) - Volume cella • Room volume m³

Temperatura cella • Cold room temperatura



+5°C

0°C

-5°C

Temperatura estern • Ambient temperatura



+20°C

+32°C

+43°C

+20°C

+32°C

+43°C

+20°C

+32°C

+43°C

W

m³

W

m³

W

m³

W

m³

W

m³

W

m³

W

m³

W

m³

W

m³

W

m³

W

m³

	+20°C		+32°C		+43°C		+20°C		+32°C		+43°C		+20°C		+32°C		+43°C	
	W	m ³	W	m ³	W	m ³	W	m ³	W	m ³	W	m ³	W	m ³	W	m ³	W	m ³
7492.0120	1005	12,4	770	9,2	580	5	830	9,4	625	5,8	465	2,8	685	6,5	505	4	370	2,2
7492.0125	1565	20,5	1215	15,5	960	8,5	1290	15,5	985	10,4	775	6	1065	10,7	800	7,8	625	4,3
7492.0130	2025	26,5	1570	20	1240	11	1670	20,1	1275	13,4	1005	7,8	1375	13,8	1035	10	810	5,5



NEGATIVE WALL-MOUNTED UNIT SLIM

INSTEELUNIT VRIES SMAL

TIEFKÜHLAGGREGAT HUCKEPACK SCHMAL

NEGATIVE WALL-MOUNTED UNIT SLIM

UNITÉ DE RÉFROIDISSEMENT TYPE NÉGATIF SMALL

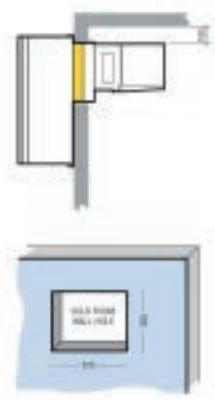

Cooking range

Drop-in

Ovens

Kitchen equipment

7492.0135

€ 3.465,-



	400 x 831 x 767
	230 V / 1,35 kW
	-18/-25°C
	R 452 A
	63

Refrigeration

Dishwashers

Neutral

Faucets

Potenza frigorifera • Refrigerating capacity (W) - Volume cella • Room volume m³

Temperatura cella • Cold room temperatura

-18 °C

-22 °C

Temperatura esterna • Ambient temperatura

+25°C

+32°C

+43°C

+25°C

+32°C

+43°C

W

m³

W

m³

W

m³

W

m³

W

m³

W

m³

Ventilation

Pizzeria

Bakery

7492.0135

1275

13,9

905

7,9

655

5,8

1035

11,3

705

5,2

495

3,7



Refrigeration

Refrigerators & Freezer Cabinets

Refrigerated & Freezer Counters

Saladettes

Coldrooms

Chest Freezers

Display Refrigeration

Ice Machines

ROOF-TOP POSITIVE MOUNTED UNIT

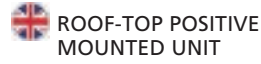

7492.0040

€ 3.390,-

7492.0045

€ 3.480,-

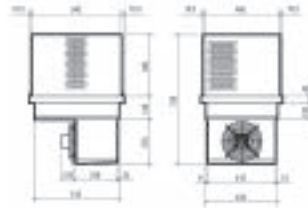

	460 x 540 x 756	460 x 540 x 756
	230 V / 0,92 kW	230 V / 1,1 kW
	-5/+5°C	-5/+5°C
	R 452 A	R 452 A
	52	54

Potenza frigorifera • Refrigerating capacity (W) - Volume cella • Room volume m³

Temperatura cella • Cold room temperatura



+5°C

0°C

-5°C

Temperatura estern • Ambient temperatura



+20°C

+32°C

+43°C

+20°C

+32°C

+43°C

+20°C

+32°C

+43°C

W

m³

W

m³

W

m³

W

m³

W

m³

W

m³

W

m³

W

m³

W

m³

7492.0040

1565

20,5

1215

15,5

960

8,5

1290

15,5

985

10,4

775

6

1065

10,7

800

7,8

625

4,3

7492.0045

1965

28,1

1520

19,3

1205

11,4

1620

20

1240

14,1

975

8,2

1335

13,5

1000

8,8

785

5,9

 DAKUNIT VRIES

 DECKENSTOPFER
TIEFKÜHLAGGREGAT

 ROOF-TOP NEGATIVE
MOUNTED UNIT

 UNITÉ DE PLAFONNIERS
TYPE NÉGATIF







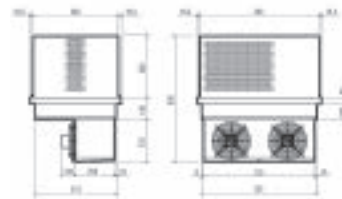

7492.0050

€ 5.015,-

7492.0055

€ 5.235,-



	760 x 540 x 806	760 x 540 x 806
	230 V / 1,46 kW	400 V / 1,81 kW
	-18/-25°C	-18/-25°C
	R 452 A	R 452 A
	79	81

Potenza frigorifera • Refrigerating capacity (W) - Volume cella • Room volume m³

Temperatura cella • Cold room temperatura

-18 °C

-22 °C

Temperatura esterna • Ambient temperatura

+20°C

+32°C

+43°C

+20°C

+32°C

+43°C

W

m³

W

m³

W

m³

W

m³

W

m³

W

m³

7492.0050

1400

16,4

1015

10

755

7,1

1110

11,7

800

7

575

4,8

7492.0055

1870

23,1

1365

13,7

920

9,1

1540

17,7

1090

9,8

700

6,3



Refrigeration

CHEST FREEZER SS COVER



Refrigerators & Freezer Cabinets

Refrigerated & Freezer Counters

Saladettes

Coldrooms

Chest Freezers

Display Refrigeration

Ice Machines

	7151.1100	7151.1105	7151.1110
	€ 580,-	€ 690,-	€ 810,-
	765 x 743 x 840	1041 x 743 x 840	1316 x 743 x 840
	638 x 528 x 668	915 x 528 x 668	1189 x 528 x 668
		7151.1100 A 406 B 232 C 413 D 668 E 638 F 528 7151.1105 A 683 B 232 C 413 D 668 E 915 F 528 7151.1110 A 957 B 232 C 413 D 668 E 1189 F 528	
	230 V	230 V	230 V
	202 L	305 L	407 L
	-18/-24°C	-18/-24°C	-18/-24°C
	R 600 A	R 600 A	R 600 A
	1x	1x	1x
	39	47	54

VRIESKIST RVS DEKSEL

- LED verlichting
- Omgevingstemperatuur +43°C
- Manuele thermostaat
- Isolatie 60 mm
- RVS deksel
- LED-verlichting in de deksel
- Incl. ijskrabber
- Met waterafvoer in de bodem

TIEFKÜHLTRUHE EDELSTAHL DECKEL

- LED Beleuchtung
- Umgebungstemperatur +43°C
- Manuelles Thermostat
- Isolierschicht 60 mm
- Edelstahl Deckel
- LED-Beleuchtung im Deckel
- Inkl. Eiskratzer
- Mit Wasserablauf im Boden

CHEST FREEZER SS COVER

- LED lighting
- Ambient temp. +43°C
- Analog temperature controller
- 60 mm insulation
- Stainless steel lid
- LED lighting in the lid
- Incl. ice scraper
- With water drainage in the bottom

CONGÉLATEUR BAHUT COUVERCLE EN INOX

- Éclairage LED
- Temp. ambiente +43°C
- Régulateur de température analogique
- Isolation 60 mm
- Couvercle en acier inoxydable
- Éclairage LED dans le couvercle
- Incl. Grattoir à glace
- Avec drainage de l'eau dans le fond

7151.9005 € 15,-

	Basket freezer
>	7450.1100-1105-1110

7151.9020 € 25,-

	Castors set
>	7450.1100-1105-1110



CHEST FREEZER SS COVER

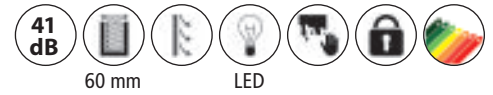

	7151.1115	7151.1120	7151.1125
	€ 930,-	€ 1.120,-	€ 1.185,-
	1492 x 743 x 840	1775 x 743 x 840	1904 x 743 x 840
	1366 x 528 x 668	1649 x 528 x 668	1777 x 528 x 668
		7151.1115 A 1134 B 232 C 413 D 668 E 1366 F 528 7151.1120 A 1417 B 232 C 413 D 668 E 1649 F 528 7151.1125 A 1545 B 232 C 413 D 668 E 1777 F 528	
	230 V	230 V	230 V
	469 L	572 L	635 L
	-18/-24°C	-18/-24°C	-18/-24°C
	R 600 A	R 600 A	R 600 A
	2x	2x	2x
	58	69	71

VRISKIST RVS DEKSEL

- LED verlichting
- Omgevingstemperatuur +43°C
- Manuele thermostaat
- Isolatie 60 mm
- RVS deksel
- LED-verlichting in de deksel
- Incl. ijskrabber
- Met waterafvoer in de bodem

TIEFKÜHLTRUHE EDELSTAHL DECKEL

- LED Beleuchtung
- Umgebungstemperatur +43°C
- Manuelles Thermostat
- Isolierschicht 60 mm
- Edelstahl Deckel
- LED-Beleuchtung im Deckel
- Inkl. Eiskratzer
- Mit Wasserablauf im Boden

CHEST FREEZER SS COVER

- LED lighting
- Ambient temp. +43°C
- Analog temperature controller
- 60 mm insulation
- Stainless steel lid
- LED lighting in the lid
- Incl. ice scraper
- With water drainage in the bottom

CONGÉLATEUR BAHUT COUVERCLE EN INOX

- Éclairage LED
- Temp. ambiente +43°C
- Régulateur de température analogique
- Isolation 60 mm
- Couvercle en acier inoxydable
- Éclairage LED dans le couvercle
- Incl. Grattoir à glace
- Avec drainage de l'eau dans le fond

7151.9005 € 15,-

	Basket freezer
>	7450.1115-1120-1125

7151.9020 € 25,-

	Castors set
>	7450.1115-1120-1125



Refrigeration

CHEST FREEZER



Refrigerators & Freezer Cabinets

Refrigerated & Freezer Counters

Saladettes

Coldrooms

Chest Freezers

Display Refrigeration

Ice Machines

7450.0192

€ 1.325,-



7450.0194

€ 1.585,-



	1852 x 778 x 845	2165 x 865 x 885
	230 V	230 V
	526 L	718 L
	< -18°C	< -18°C
	R 290	R 290
dB	54	55
	1x	1x
	90	100

VRIESKIST

- Statische koeling
- Handmatige ontthooing
- Inclusief 1 mand
- Omgevingstemperatuur 32 °C
- Glazen schuifdeksel

TIEFKÜHLTRUHE

- Statische Kühlung
- Manuelle Abtauung
- Inklusive 1 Korb
- Umgebungstemperatur 32 °C
- Glasschiebedeckel

CHEST FREEZER

- Static cooler
- Manual defrost
- Including 1 basket
- Ambient temp. +32°C
- Sliding glass cover

CONGÉLATEUR BAHUT

- Froid statique
- Dégivrage manuel
- Incl. 1 panier
- Temp. ambiente +32°C
- Couverture coulissant en verre



CHEST FREEZER

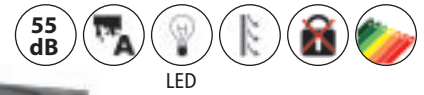

Cooking range

Drop-in

Ovens

Kitchen equipment

7072.0100	7072.0110	7072.0115 *	7072.0105
€ 2.360,-	€ 2.730,-	€ 3.295,-	€ 2.710,-

Refrigeration

	7072.0100	7072.0110	7072.0115 *	7072.0105
				KOP ELEMENT KOPF ELEMENT HEAD ELEMENT ÉLÉMENT DE LA TÊTE
	1879 x 952 x 950	2124 x 952 x 950	2508 x 952 x 950	2008 x 952 x 950
	1731 x 780 x 815	1976 x 780 x 815	2360 x 780 x 815	1860 x 780 x 815
	230 V / 0,395 kW	230 V / 0,38 kW	230 V / 0,42 kW	230 V / 0,36 kW
	985 L	1136 L	1372 L	988 L
	-18/-23°C	-18/-23°C	-18/-23°C	-18/-23°C
	R 290	R 290	R 290	R 290
	3x divider	3x divider	4x divider	3x divider
	183	195	198	185

Dishwashers

Neutral

Faucets

(* EXPORT TRANSPORTKOSTEN OP AANVRAAG | TRANSPORTKOSTEN AUF ANFRAGE | TRANSPORT COSTS ON REQUEST | FRAIS DE TRANSPORT SUR DEMANDE

VRIESKIST

- Statische koeling
- Automatische ontdooiing
- LED verlichting
- Isolatie 71 mm
- Omgevingstemperatuur 25°C
- Digitale thermostaat
- Glazen schuifdeksel
- Verstelbare pootjes

TIEFKÜHLTRUHE

- Statische Kühlung
- Automatische Abtauung
- LED Beleuchtung
- Isolierschicht 71 mm
- Umgebungstemperatur 25°C
- Digitales Thermostat
- Glasschiebedeckel
- Einstellbare FüÙe

CHEST FREEZER

- Static cooler
- Automatic defrost
- LED Lighting
- Insulation 71 mm
- Ambient temp. +25°C
- Digital thermostat
- Sliding glass cover
- Adjustable feet

CONGÉLATEUR BAHUT

- Froid statique
- Dégivrage automatique
- Éclairage LED
- Isolation 71 mm
- Temp. ambiante +25°C
- Thermostat numérique
- Couverture coulissante en verre
- Pieds réglables

Ventilation

Pizzeria

Chest Freezer joint		€ 135,-		
		7072.9010	7072.9015	7072.9020
	>	7072.0100	7072.0110	7072.0115
	B	1880	2125	2500

Divider		€ 25,-	
		7072.9060	7072.9065
	>	7072.0100 7072.0110 7072.0115	7072.0105

Basket freezer		€ 55,-	
		7072.9002	7072.9005
	>	7072.0100 7072.0110 7072.0115	7072.0105

Bakery



Refrigeration

CHEST FREEZER

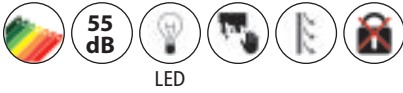

Refrigerators & Freezer Cabinets

Refrigerated & Freezer Counters

Saladettes

Coldrooms

Chest Freezers

Display Refrigeration

Ice Machines

7072.0030

€ 2.490,-



	2124 x 952 x 894
	1976 x 780 x 590
	230 V / 0,395 kW
	1005 L
	-18/-23°C
	R 290
	162

VRIESKIST

- Statische koeling
- Handmatige ontdooing
- LED verlichting
- Isolatie 71 mm
- Omgevingstemperatuur 25°C
- Digitale thermostaat
- Glazen schuifdeksel
- Verstelbare pootjes

TIEFKÜHLTRUHE

- Statische Kühlung
- Manuelle Abtauung
- LED Beleuchtung
- Isolierschicht 71 mm
- Umgebungstemperatur 25°C
- Digitales thermostat
- Glasschiebedeckel
- Einstellbare FüÙe

CHEST FREEZER

- Static cooler
- Manual defrost
- LED Lighting
- Insulation 71 mm
- Ambient temp. +25°C
- Digital thermostat
- Sliding glass cover
- Adjustable feet

CONGÉLATEUR BAHUT

- Froid statique
- Dégivrage manuel
- Éclairage LED
- Isolation 71 mm
- Temp. ambiente +25°C
- Thermostat numérique
- Couverture coulissante en verre
- Pieds réglables

7072.9015



€ 135,-



Chest Freezer joint

> 7072.0030

B 2125

7072.9025



€ 55,-

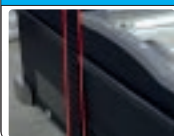

Chest Freezer joint

For island without head element



CHEST FREEZER

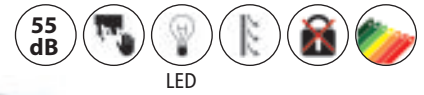

Cooking range

Drop-in

Ovens

Kitchen equipment

7072.0005	7072.0015	7072.0020 *	7072.0010
€ 1.790,-	€ 2.230,-	€ 2.725,-	€ 2.190,-

	7072.0005	7072.0015	7072.0020 *	7072.0010
	1879 x 952 x 894	2124 x 952 x 894	2508 x 952 x 894	2008 x 952 x 894
	1731 x 780 x 590	1976 x 780 x 590	2360 x 780 x 590	1860 x 780 x 537
	230 V / 0,395 kW	230 V / 0,38 kW	230 V / 0,42 kW	230 V / 0,36 kW
	870 L	1005 L	1216 L	864 L
	-18/-23°C	-18/-23°C	-18/-23°C	-18/-23°C
	R 290	R 290	R 290	R 290
	3x divider	3x divider	4x divider	3x divider
	153	162	175	155

(*) EXPORT TRANSPORTKOSTEN OP AANVRAAG | TRANSPORTKOSTEN AUF ANFRAGE | TRANSPORT COSTS ON REQUEST | FRAIS DE TRANSPORT SUR DEMANDE

Refrigeration

Dishwashers

Neutral

Faucets

VRIESKIST

- Statische koeling
- Handmatige ontdooiing
- LED verlichting
- Isolatie 71 mm
- Omgevingstemperatuur 25°C
- Digitale thermostaat
- Glazen schuifdeksel
- Verstelbare pootjes

TIEFKÜHLTRUHE

- Statische Kühlung
- Manuelle Abtauung
- LED Beleuchtung
- Isolierschicht 71 mm
- Umgebungstemperatur 25°C
- Digitales thermostat
- Glasschiebedeckel
- Einstellbare Füße

CHEST FREEZER

- Static cooler
- Manual defrost
- LED Lighting
- Insulation 71 mm
- Ambient temp. +25°C
- Digital thermostat
- Sliding glass cover
- Adjustable feet

CONGÉLATEUR BAHUT

- Froid statique
- Dégivrage manuel
- Éclairage LED
- Isolation 71 mm
- Temp. ambiente +25°C
- Thermostat numérique
- Couverture coulissante en verre
- Pieds réglables

Ventilation

Pizzeria

Chest Freezer joint				€ 135,-
		7072.9010	7072.9015	7072.9020
	>	7072.0005	7072.0015	7072.0020
B		1880	2125	2500

7072.9050		€ 20,-
	Divider	
>	7072.0005	7072.0010
	7072.0015	7072.0020

Basket freezer			€ 55,-
		7072.9000	7072.9005
>	7072.0005	7072.0015	7072.0020

Bakery



Refrigeration

CHEST FREEZER



Refrigerators & Freezer Cabinets

Refrigerated & Freezer Counters

Saladettes

Coldrooms

Chest Freezers

Display Refrigeration

Ice Machines

7072.0065

€ 2.345,-



	2124 x 952 x 894
	1976 x 780 x 590
	230 V / 0,395 kW
	1005 L
	-18/-23°C
	R 290
	162

VRIESKIST

- Statische koeling
- Handmatige ontdooing
- LED verlichting
- Isolatie 71 mm
- Omgevingstemperatuur 25°C
- Digitale thermostaat
- Glazen schuifdeksel
- Verstelbare pootjes

TIEFKÜHLTRUHE

- Statische Kühlung
- Manuelle Abtauung
- LED Beleuchtung
- Isolierschicht 71 mm
- Umgebungstemperatur 25°C
- Digitales thermostat
- Glasschiebedeckel
- Einstellbare Füße

CHEST FREEZER

- Static cooler
- Manual defrost
- LED Lighting
- Insulation 71 mm
- Ambient temp. +25°C
- Digital thermostat
- Sliding glass cover
- Adjustable feet

CONGÉLATEUR BAHUT

- Froid statique
- Dégivrage manuel
- Éclairage LED
- Isolation 71 mm
- Temp. ambiente +25°C
- Thermostat numérique
- Couverture coulissante en verre
- Pieds réglables

7072.9035



€ 135,-



Chest Freezer joint

> 7072.0065

B 2125

7072.9045



€ 70,-



Chest Freezer joint

For island without head element



CHEST FREEZER



7072.0045	7072.0055	7072.0060 *	7072.0050
€ 1.790,-	€ 2.199,-	€ 2.730,-	€ 2.230,-

	7072.0045	7072.0055	7072.0060 *	7072.0050
	KOP ELEMENT KOPF ELEMENT HEAD ELEMENT ÉLÉMENT DE LA TÊTE			
	1879 x 952 x 894	2124 x 952 x 894	2508 x 952 x 894	2008 x 952 x 894
	1731 x 780 x 590	1976 x 780 x 590	2360 x 780 x 590	1860 x 780 x 537
	230 V / 0,395 kW	230 V / 0,38 kW	230 V / 0,42 kW	230 V / 0,36 kW
	870 L	1005 L	1216 L	864 L
	-18/-23°C	-18/-23°C	-18/-23°C	-18/-23°C
	R 290	R 290	R 290	R 290
	3x divider	3x divider	4x divider	3x divider
	153	162	175	155

(*) EXPORT TRANSPORTKOSTEN OP AANVRAAG | TRANSPORTKOSTEN AUF ANFRAGE | TRANSPORT COSTS ON REQUEST | FRAIS DE TRANSPORT SUR DEMANDE

VRIESKIST

- Statische koeling
- Handmatige ontdooiing
- LED verlichting
- Isolatie 71 mm
- Omgevingstemperatuur 25°C
- Digitale thermostaat
- Glazen schuifdeksel
- Verstelbare pootjes

TIEFKÜHLTRUHE

- Statische Kühlung
- Manuelle Abtauung
- LED Beleuchtung
- Isolierschicht 71 mm
- Umgebungstemperatur 25°C
- Digitales thermostat
- Glasschiebedeckel
- Einstellbare Füße

CHEST FREEZER

- Static cooler
- Manual defrost
- LED Lighting
- Insulation 71 mm
- Ambient temp. +25°C
- Digital thermostat
- Sliding glass cover
- Adjustable feet

CONGÉLATEUR BAHUT

- Froid statique
- Dégivrage manuel
- Éclairage LED
- Isolation 71 mm
- Temp. ambiente +25°C
- Thermostat numérique
- Couverture coulissante en verre
- Pieds réglables

Chest Freezer joint				€ 135,-
		7072.9030	7072.9035	7072.9040
	>	7072.0045	7072.0055	7072.0060
B		1880	2125	2500

7072.9050		€ 20,-
	Divider	
>	7072.0045	7072.0055
	7072.0060	7072.0050

Basket freezer			€ 55,-
		7072.9000	7072.9005
>	7072.0045	7072.0055	7072.0060



Refrigeration

WALL MOUNTED COLD / FREEZER UNIT



	7455.2500	7455.2505	7455.2510	7455.2515
	€ 4.420,-	€ 5.155,-	€ 4.600,-	€ 5.410,-
	1454 x 890 x 2102	2104 x 890 x 2102	1454 x 890 x 2102	2104 x 890 x 2102
	Top 230 V / 0,405 kW Bottom 230 V / 0,42 kW	Top 230 V / 0,74 kW Bottom -230 V / 0,5 kW	Top 230 V / 0,405 kW Bottom 230 V / 0,42 kW	Top 230 V / 0,74 kW Bottom -230 V / 0,5 kW
	373 / 575 L	546 / 900 L	373 / 575 L	546 / 900 L
	Top 0/+10°C Bottom -18/-22°C	Top 0/+10°C Bottom -18/-22°C	Top 0/+10°C Bottom -18/-22°C	Top 0/+10°C Bottom -18/-22°C
	R 290	R 290	R 290	R 290
	Top 4x shelves Bottom 2x dividers	Top 6x shelves Bottom 4x divider	Top 4x shelves Bottom 2x dividers	Top 6x shelves Bottom 4x divider
	281	373	281	373

WAND KOEL / VRIES COMBI

- 7455.2500-2510: Boven 4 verstelbare roosters
- 7455.2505-2515: Boven 6 verstelbare roosters
- Afstand tussen roosters 90 mm
- Max. gewicht per rooster 18 kg
- Met LED Verlichting
- Isolatie 60 mm
- Bovenzijde Geforceerde koeling
- Onder statische koeling
- Digitale thermostaat

WANDKÜHLUNG / TIEFKÜHLUNG

- 7455.2500-2510: Oben 4 einstellbare Gitter
- 7455.2505-2515: Oben 6 einstellbare Gitter
- Abstand zwischen Gitter 90 mm
- Max. 18 kg pro Gitter
- LED Beleuchtung
- Isolierschicht 60 mm
- Oben Umluft Kühlung
- Unten statische Kühlung
- Digitales Thermostat

WALL MOUNTED COLD / FREEZER UNIT

- 7455.2500-2510: Top 4 adjustable grids
- 7455.2505-2515: Top 6 adjustable grids
- Distance between grids 90 mm
- Max. weight per grid 18 kg
- LED Lighting
- Insulation 60 mm
- Top forced cooling
- Under static cooling
- Digital thermostat

CHAMBRE MURALE FROIDE / FRIGORIFIQUES

- 7455.2500-2510: Top 4 grilles réglables
- 7455.2505-2515: Top 6 grilles réglables
- Distance entre les grilles 90 mm
- Max. poids par grille 18 kg
- Éclairage LED
- Isolation 60 mm
- Refroidissement renforcé par le haut
- Sous refroidissement statique
- Thermostat numérique

7455.2540 € 20,-

Divider

7455.2288 € 11,-

Price card holder L & R

7455.2289 € 11,-

Price card holder middle



WALL MOUNTED FREEZER UNIT



60 mm TOP

BOTTOM LED



Cooking range

Drop-in

Ovens

Kitchen equipment

Refrigeration

Dishwashers

Neutral

Faucets

Ventilation

Pizzeria

Bakery

	7455.2520	7455.2525	7455.2530	7455.2535
	€ 5.350,-	€ 6.430,-	€ 5.460,-	€ 6.240,-
	1454 x 890 x 2102	2104 x 890 x 2102	1454 x 890 x 2102	2104 x 890 x 2102
	Top 230 V / 0,73 kW Bottom 230 V / 0,42 kW	Top 230 V / 0,79 kW Bottom -230 V / 0,5 kW	Top 230 V / 0,73 kW Bottom 230 V / 0,42 kW	Top 230 V / 0,79 kW Bottom -230 V / 0,5 kW
	373 / 575 L	546 / 900 L	373 / 575 L	546 / 900 L
	-18/-22°C	-18/-22°C	-18/-22°C	-18/-22°C
	R 290	R 290	R 290	R 290
	Top 4x shelves Bottom 2x dividers	Top 6x shelves Bottom 4x divider	Top 4x shelves Bottom 2x dividers	Top 6x shelves Bottom 4x divider
	298	391	298	391

WAND VRIESKAST

- 7455.2520-2530: Boven 4 verstelbare roosters
- 7455.2525-2535: Boven 6 verstelbare roosters
- Afstand tussen roosters 90 mm
- Max. gewicht per rooster 18 kg
- Met LED Verlichting
- Isolatie 60 mm
- Bovenzijde Geforceerde koeling
- Onder statische koeling
- Digitale thermostaat

WANDTIEFKÜHLUNG

- 7455.2520-2530: Oben 4 einstellbare Gitter
- 7455.2525-2535: Oben 6 einstellbare Gitter
- Abstand zwischen Gitter 90 mm
- Max. 18kg pro Gitter
- LED Beleuchtung
- Isolierschicht 60 mm
- Oben Umluft Kühlung
- Unten statische Kühlung
- Digitales Thermostat

WALL MOUNTED FREEZER UNIT

- 7455.2520-2530: Top 4 adjustable grids
- 7455.2525-2535: Top 6 adjustable grids
- Distance between grids 90 mm
- Max. weight per grid 18 kg
- LED Lighting
- Insulation 60 mm
- Top forced cooling
- Under static cooling
- Digital thermostat

CHAMBRE MURALE FRIGORIFIQUES

- 7455.2520-2530: Top 4 grilles réglables
- 7455.2525-2535: Top 6 grilles réglables
- Distance entre les grilles 90 mm
- Max. poids par grille 18 kg
- Éclairage LED
- Isolation 60 mm
- Refroidissement renforcé par le haut
- Sous refroidissement statique
- Thermostat numérique

7455.2540

€ 20,-



Divider

7455.2288

€ 11,-

Price card holder L & R

7455.2289

€ 11,-

Price card holder middle



Refrigeration

Refrigerators & Freezer Cabinets

Refrigerated & Freezer Counters

Saladettes

Coldrooms

Chest Freezers

Display Refrigeration

Ice Machines

CHEST FREEZER GLASS COVER



60 mm



	7151.1000	7151.1005	7151.1010	7151.1015
	€ 730,-	€ 865,-	€ 945,-	€ 1.115,-
	767 x 659 x 879	1043 x 659 x 879	1318 x 659 x 879	1494 x 659 x 879
	639 x 529 x 536	915 x 529 x 536	1190 x 529 x 536	1366 x 529 x 536
	<p>7151.1000 A 406 B 231 C 283 D 536 E 639 F 529 7151.1005 A 683 B 231 C 283 D 536 E 914 F 529 7151.1010 A 958 B 231 C 283 D 536 E 1189 F 529 7151.1015 A 1135 B 231 C 283 D 536 E 1366 F 529</p>			
	230 V / 0,1 kW	230 V / 0,13 kW	230 V / 0,15 kW	230 V / 0,19 kW
	198 L	297 L	397 L	461 L
	-18/-24°C	-18/-24°C	-18/-24°C	-18/-24°C
	R 600A	R 290	R 290	R 452 A
	53	68	79	90

VRIESKIST GLASDEKSEL

Geleverd zonder mandjes

- Statische koeling
- Handmatige ontdooing
- Manuele thermostaat
- 45-47 Decibel
- Omgevingstemperatuur +35°C
- Isolatie 60mm
- Glazen schuifdeksel
- Incl. ijskrabber
- Met waterafvoer in de bodem

7151.9000 € 15,-

Basket freezer

TIEFKÜHLTRUHE GLASDECKEL

Lieferung ohne Körbe

- Statische Kühlung
- Manuelle Abtauung
- Manuelles Thermostat
- 45-47 Decibel
- Umgebungstemperatur +35°C
- Isolierschicht 60mm
- Glasschiebedeckel
- Inkl. Eiskratzer
- Mit Wasserablauf im Boden

7151.9010 € 25,-

Castors set

> 7450.1000-1005

CHEST FREEZER GLASS COVER

Supplied without baskets

- Static cooler
- Manual defrost
- Analog temperature controller
- 45-47 Decibel
- Ambient temp. +35°C
- Insulation 60mm
- Sliding glass cover
- Incl. ice scraper
- With water drainage in the bottom

7151.9015 € 25,-

Castors set

> 7450.1010-1015

CONGÉLATEUR BAHUT COUVERCLE EN VERRE

Livré sans paniers

- Froid statique
- Dégivrage manuel
- Régulateur de temp rature analogique
- 45-47 Decibel
- Temp. ambiente +35°C
- Isolation 60mm
- Couvercle coulissant en verre
- Incl. Grattoir à glace
- Avec drainage de l'eau dans le fond



BLASTCHILLER

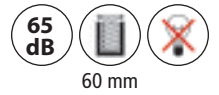

Cooking range

Drop-in

Ovens

Kitchen equipment

Refrigeration

Dishwashers

Neutral

Faucets

Ventilation

Pizzeria

Bakery

	7489.5205	7489.5210	7489.5215	7489.5217
	€ 3.820,-	€ 4.865,-	€ 5.395,-	€ 9.815,-
	800 x 750 x 870	800 x 750 x 1210	800 x 750 x 1410	800 x 850 x 2010
	230 V / 1,2 kW	230 V / 2,2 kW	230 V / 2,2 kW	400 V / 3,5 kW
	20 kg +90/+3°C 15 kg +90/-18°C	25 kg +90/+3°C 15 kg +90/-18°C	30 kg +90/+3°C 25 kg +90/-18°C	35 kg +90/+3°C 30 kg +90/-18°C
	R 290	R 290	R 290	R 452 A
GN	5x 1/1 GN	7x 1/1GN	10x 1/1 GN	15x 1/1 GN
	132	201	201	263

BLASTCHILLER

- Isolatie 60 mm
- Omgevingstemp. +38°C
- Vast ingebouwde compressor
- 1/1 GN of 40x60 roosters
- Cap. 5/7/10/15 geleiders

SCHNELLKÜHLER

- Isolierschicht 60 mm
- Umgebungstemp. +38°C
- Fest installierte Kompressor
- 1/1 GN oder 40x60 Gitter
- Für maximal 5/7/10/15 Führungsschienen

BLASTCHILLER

- Insulation 60 mm
- Ambient temp. +38°C
- Permanently installed compressor
- 1/1 GN or 40x60 grids
- Cap. 5/7/10/15 guides

REFROIDISSEUR À VENTILATION

- Isolation 60 mm
- Temp. ambiente +38°C
- Compresseur fixé
- 1/1 GN ou 40x60 Grilles
- Cap. 5/7/10/15 Glissières

7489.0506 € 65,-



Grids

7489.0570 € 30,-



Set of guides

60Hz



ON REQUEST



Refrigeration

Refrigerators & Freezer Cabinets

Refrigerated & Freezer Counters

Saladettes

Coldrooms

Chest Freezers

Display Refrigeration

Ice Machines

FREEZER GLASS DOOR



7295.0070

€ 2.710,-



7295.0075

€ 3.880,-



MARIN

	520 x 740 x 1935	520 x 740 x 1935
	230 V / 0,7 kW	230V / 0,75 kW
	-18°C	-18°C
	R 290	R 290
	✓	✗
	✗	✓
	353 L	353 L
	7x + 1 bottom	5x + 1 bottom

VRIESKAST GLASDEUR

- LED verlichting
- Automatische ontdooiing
- Omgevingstemperatuur +35°C
- 7295.0070: statische vriezer, vaste roosters
- 7295.0075: geventileerde vriezer, verstelbare roosters

TIEFKÜHLSCHRANK GLASTÜR

- LED Beleuchtung
- Automatische Abtauung
- Umgebungstemperatur +35°C
- 7295.0070: Statische Tiefkühlschrank, Feste Gitter
- 7295.0075: Umluft Kühlung, Einstellbare Gitter austauschbar

FREEZER GLASS DOOR

- LED lighting
- Automatic defrost
- Ambient temperature +35°C
- 7295.0070: static freezer, fixed shelves
- 7295.0075: fan cooled freezer, adjustable shelves

CONGÉLATEUR PORTE EN VERRE

- Éclairage LED
- Dégivrage automatique
- Temp. ambiente +35°C
- 7295.0070: congélateur statique, grilles fixes
- 7295.0075: congélateur ventilé, grilles ajustables



ICE CREAM STORAGE FREEZER



7472.0210

€ 1.980,-

7472.0215

€ 2.025,-

- Volledige glasdeur • Komplette Glastür
- Frameless glass door • Porte vitrée

	570 x 649 x 1835	667 x 620 x 2018
	450 x 490 x 1366	547 x 490 x 1553
	230 V / 0,26 kW	230V / 0,32 kW
	301 L	417 L
	-25/-18°C	-25/-18°C
	R 290	R 290
	4x	4x
	92	116

IJSBEWAARKAST

- LED verlichting
- Isolatie 60 mm
- Omgevingstemp. +35°C
- Statische koeler
- Handmatige ontdooing
- 7472.0210: Incl. 5 roosters en 1 bodemrooster
- 7472.0215: incl. 6 roosters en 1 bodemrooster

EIS TIEFKÜHLSCHRANK

- LED Beleuchtung
- Isolierschicht 60 mm
- Umgebungstemp. +35°C
- Statische Kühlung
- Manuelle Abtauung
- 7472.0210: Einschließlich 5 Gitter und 1 Bodenrost
- 7472.0215: Einschließlich 6 Gitter und 1 Bodenrost

ICE CREAM STORAGE FREEZER

- LED lighting
- Insulation 60 mm
- Ambient temp. +35°C
- Static cooler
- Manual defrost
- 7472.0210: Incl. 5 grids and 1 bottom grid
- 7472.0215: Incl. 6 grids and 1 bottom grid

ARMOIRE FRIGO CONSERVATION

- Éclairage LED
- Isolation 60 mm
- Temp. ambiente +35°C
- Froid statique
- Dégivrage manuel
- 7472.0210: 5 Grilles et 1 grill inférieure inclus
- 7472.0215: 6 Grilles et 1 grill inférieure inclus

Cooking range

Drop-in

Ovens

Kitchen equipment

Refrigeration

Dishwashers

Neutral

Faucets

Ventilation

Pizzeria

Bakery



Refrigeration

ICE CREAM STORAGE FREEZER



60 mm



Refrigerators & Freezer Cabinets

Refrigerated & Freezer Counters

Saladettes

Coldrooms

Chest Freezers

Display Refrigeration

Ice Machines

7489.5600

€ 4.285,-



	820 x 920 x 2080
	230 V / 0,6 kW
	785 L
	-10/-25°C
	R452a
	176

IJSBEWAARKAST

- Isolatie 60 mm
- Omgevingstemp. +32°C
- Geforceerde koeling
- Automatische ontdooiing
- Incl. 10 roosters
- Cap. 28 geleiders
- Ruimte tussen geleiders 45 mm

EIS TIEFKÜHLSCHRANK

- Isolierschicht 60 mm
- Umgebungstemp. +32°C
- Umluft Kühlung
- Automatische Abtauung
- Einschließlich 10 Gitter
- Für maximal 28 Führungsschienen
- Abstand zwischen Führungsschienen 45 mm

ICE CREAM STORAGE FREEZER

- Insulation 60 mm
- Ambient temp. +32°C
- Ventilated cooling
- Automatic defrost
- Incl. 10 grids
- Cap. 28 guides
- Space between guides 45 mm

ARMOIRE FRIGO CONSERVATION

- Isolation 60 mm
- Temp. ambiente +32°C
- Froid renforcé
- Dégivrage automatique
- 10 Grilles inclus
- Cap. 28 Glissières
- Espace entre les Glissières 45 mm

7489.0900 € 90,-



Castors set

60Hz



ON REQUEST



ICE CREAM STORAGE FREEZER

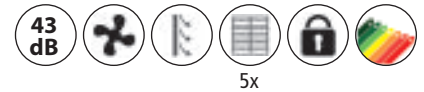

5x

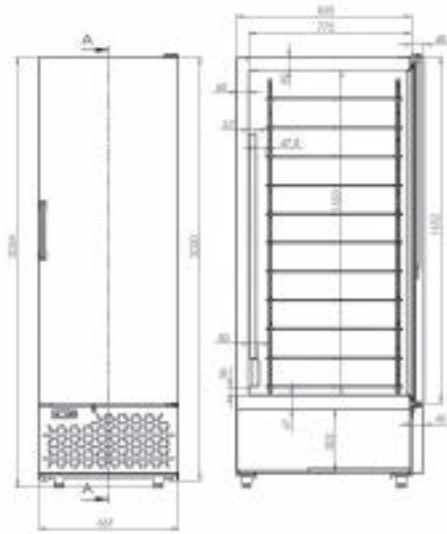

Cooking range

Drop-in

Ovens

Kitchen equipment

7472.0120

€ 2.525,-



	667 x 895 x 2020
	547 x 775 x 1553
	230 V
	231 - 66x5 L
	-15/-25°C
	R 290
	150

Refrigeration

Dishwashers

Neutral

IJSBEWAARKAST

- Digitale thermostaat
- Statische vriezer met hulpventilator
- Incl. 5 roosters
- Temperatuur alarm
- Ruimte voor 66 bakken van 5 Liter
- Voorzien van energielabel
- Met wielen
- Voorzien van slot
- RVS buitenzijde

EIS TIEFKÜHLSCHRANK

- Digitales Thermostat
- Statische Kühlung mit Ventilator
- Inklusive 5 Gitter
- Temperatur Alarm
- Kapazität für 66 Behälter von 5L.
- Mit Energielabel
- Auf Räder
- Abschließbar
- Gehäuse Edelstahl

ICE CREAM STORAGE FREEZER

- Digital thermostat
- Static freezer, fan assisted
- Incl. 5 grids
- Temperatur alarm
- Space for 66 ice bins of 5L.
- With energy label
- Mobile
- Lock
- Stainless steel housing

ARMOIRE FRIGO CONSERVATION

- Thermostat numérique
- Congélateur statique, assisté par ventilateur
- Incl. 5 grilles
- Alarme de température
- Espace pour 66 bacs de 5 litres
- Equipé d'une étiquette énergétique
- Mobile
- Fermeture à clé
- Extérieur en acier inoxydable

Faucets

Ventilation

Pizzeria

7472.0123 € 45,-



Grids

7472.0122 € 10,-



Set clips for grid

Bakery



Refrigeration

COUNTERTOP GLASS DOOR FREEZER FOR ICE CREAM

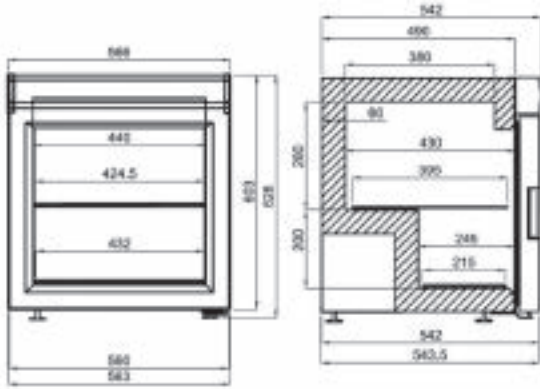

7472.0200

€ 999,-



	542 x 566 x 628
	440 x 430 x 480
	230 V / 0,215 kW
	73 L
	-18/-22°C
CAP	5x 5 L
	R 290
	42

GLASDEUR VRIEZER TAFELMODEL TBV IJS

- LED verlichting
- Statische vriezer
- Thermometer
- Manuele thermostaat
- Zelfsluitende frameleze deur
- Omgevingstemperatuur +35°C

TISCHMODELL TIEFKÜHLSCHRANK FÜR EIS MIT GLASTÜR

- LED Beleuchtung
- Statische Tiefkühlschrank
- Thermometer
- Manuelle Thermostat
- Selbstschließend, Tür komplett Glas
- Umgebungstemperatur +35°C

COUNTERTOP GLASS DOOR FREEZER FOR ICE CREAM

- LED lighting
- Static freezer
- Thermometer
- Manual thermostat
- Self-closing frameless door
- Ambient temperature +35°C

CONGÉLATEUR PORTE EN VERRE POUR CRÈME GLACÉE

- Éclairage LED
- Congélateur statique
- Thermometer
- Thermostat manuel
- Porte sans cadre avec fermeture automatique
- Temp. ambiente +35°C



COUNTERTOP MODEL ICE CREAM DISPLAY



7292.0005



7292.0015



7292.0010



7292.0020

7292.0005	7292.0010	7292.0015	7292.0020
€ 1.375,-	€ 1.375,-	€ 1.375,-	€ 1.375,-
WHITE	BLACK	WHITE	BLACK

	7292.0005	7292.0010	7292.0015	7292.0020
	OPENT AAN DE BEDIENINGSZIJDE ÖFFNET AUF DER BEDIENUNG SEITE OPENS ON THE OPERATING SIDE S'OUVRE DU CÔTÉ FONCTIONNEMENT		OPENT AAN DE KLANTZIJDE ÖFFNET AUF DER KUNDENSEITE OPENS ON THE CUSTOMER SIDE S'OUVRE DU CÔTÉ CLIENT	
H	670 x 750 x 375	670 x 750 x 375	670 x 750 x 375	670 x 750 x 375
H	550 x 415 x 150	550 x 415 x 150	550 x 415 x 150	550 x 415 x 150
⚡	230 V / 0,195 kW	230 V / 0,195 kW	230 V / 0,195 kW	230 V / 0,195 kW
°C	-16/-18°C	-16/-18°C	-16/-18°C	-16/-18°C
R	R 290	R 290	R 290	R 290
CAP	3x 5 L	3x 5 L	3x 5 L	3x 5 L
KG	67	67	67	67

TAFELMODEL SCHEPIJSVITRINE

Excl. ijsbakken

- LED verlichting
- Intelligent temperatuurregelsysteem
- Veiligheidsglas met verwarmingselement
- Deur met dempend scharnier, kan in geopende stand stoppen
- Omgevingstemperatuur 30°C

TISCHMODELL SPEISEISVITRINE

Exkl. Speiseis Behälter

- LED beleuchtung
- Intelligentes Temperaturregelsystem
- Sicherheitsglas mit Heizelement
- Kappe bleibt in geöffnete Stand offen
- Umgebungstemperatur 30°C

COUNTERTOP MODEL ICE CREAM DISPLAY

Excl. ice cream trays

- LED lighting
- Intelligent temperature control system
- Safety glass with heating element
- Door with damping hinge, can stop at open position
- Ambient temp. 30°C

MODÈLE DE TABLE VITRINE À CREME GLACÉ

Excl. bacs pour crème glacée

- Éclairage LED
- Système de contrôle de température intelligent
- Verre de sécurité avec élément chauffant
- Porte avec charnière d'amortissement, peut s'arrêter en position ouverte
- Temp. ambiante. 30°C



Refrigeration

ICE CREAM DISPLAY



Refrigerators & Freezer Cabinets

Refrigerated & Freezer Counters

Saladettes

Coldrooms

Chest Freezers

Display Refrigeration

Ice Machines

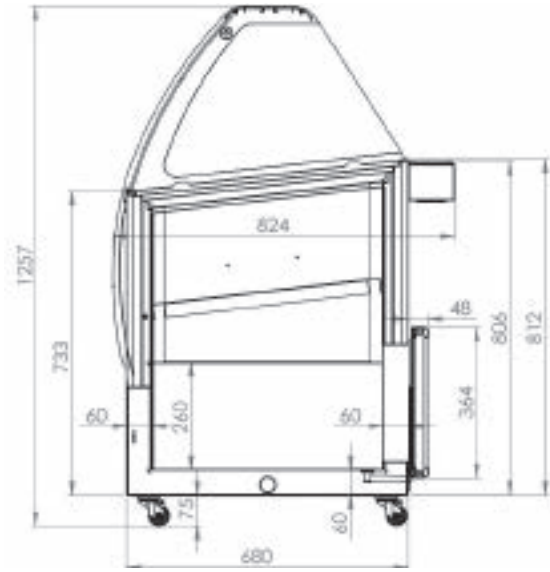

7472.0100

€ 2.030,-



BALI



7472.0105

€ 2.275,-



CURACAO



7472.0110

€ 2.405,-



MALTA



	1192 x 825 x 1257	1447 x 825 x 1257	1662 x 825 x 1257
	1060 x 560 x 687	1315 x 560 x 687	1530 x 560 x 687
	230 V / 0,37 kW	230 V / 0,5 kW	230 V / 0,63 kW
	354 - 9x5 L	454 - 10x5 L	557 - 13x5 L
	-22/-15°C	-22/-15°C	-22/-15°C
	R 290	R 290	R 290
	99	116	130

SCHEPIJSVITRINE

- LED verlichting
- Statische vriezer
- Thermometer
- Manuele thermostaat
- LED verlichting in front
- Vzv schuifruit
- Onderkoeling / opslag
- Incl. schepijslepel wasbak
- Verrijdbaar

SPEISEISVITRINE

- LED Beleuchtung
- Statische Kühlung
- Thermometer
- Manuelle Thermostat
- LED Beleuchtung Vorderseite
- Glasschiebdeckel
- Kühlung unten / Lager
- Inklusive Becken für Eislöffel
- Auf Räder

ICE CREAM DISPLAY

- LED Lighting
- Static freezer
- Thermometer
- Manual thermostat
- LED lighting in front
- Sliding glass lid
- Cooling below / storage
- Incl. scoop sink for ice cream scoop
- Mobile

VITRINE À CREME GLACÉE

- Éclairage LED
- Congélateur statique
- Thermometer
- Thermostat manuel
- Éclairage LED à l'avant
- Equipé de vitre coulissante
- Refroidissement en dessous / stockage
- Incl. Cuillère à glace évier
- Mobile

7476.0225



€ 22,-



Ice cream tray



ICE CREAM DISPLAY



Cooking range

Drop-in

Ovens

Kitchen equipment

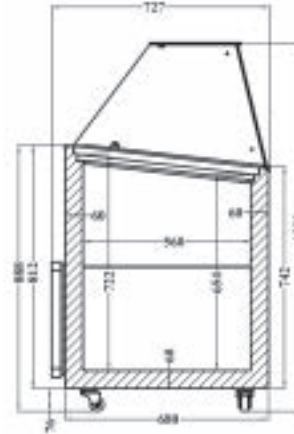

Refrigeration

Dishwashers

Neutral

Faucets

Ventilation

Pizzeria

Bakery

7472.0125

€1.055,-



CORSICA



7472.0130

€ 1.290,-



JAVA



7472.0135

€ 1.490,-



TENERIFE



	909 x 644 x 1229	1184 x 727 x 1229	1439 x 727 x 1229
	785 x 520 x 688	1060 x 560 x 688	1315 x 560 x 688
	230 V / 0,19 kW	230 V / 0,2 kW	230 V / 0,26 kW
	231 - 6x5 L	355 - 8x5 L	454 - 10x5 L
	-24/-14°C	-24/-14°C	-24/-14°C
	R 290	R 290	R 290
	71	85	101

SCHEPIJSVITRINE

- Statische vriezer
- Thermometer
- Manuele thermostaat
- Onderkoeling / opslag (niet bij 7472.0125)
- Vzv schuifruit
- Vrijrijdbaar

SPEISEISVITRINE

- Statische Kühlung
- Thermometer
- Manuelle Thermostat
- Kühlung unten / Lager (nicht bei 7472.0125)
- Glasschiebdeckel
- Auf Räder

ICE CREAM DISPLAY

- Static freezer
- Thermometer
- Manual thermostat
- Cooling below / storage (not with 7472.0125)
- Sliding glass lid
- Mobile

VITRINE À CREME GLACÉE

- Congélateur statique
- Thermomètre
- Thermostat manuel
- Refroidissement en dessous / stockage (pas avec 7472.0125)
- Equipé de vitre coulissante
- Mobile

7476.0225

€ 22,-



Ice cream tray



Refrigeration

ICE CREAM DISPLAY



Refrigerators & Freezer Cabinets

Refrigerated & Freezer Counters

Saladettes

Coldrooms

Chest Freezers

Display Refrigeration

Ice Machines

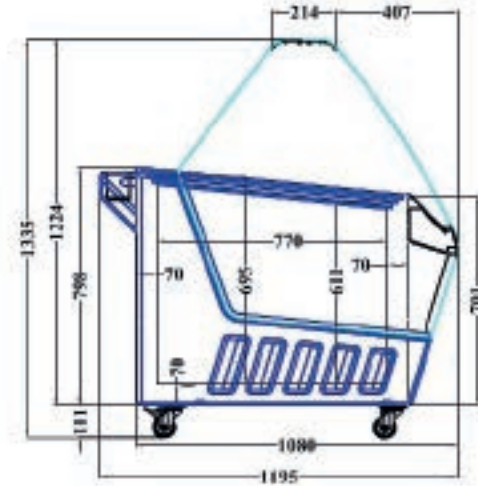

7472.0115

€ 5.295,-



HAWAII

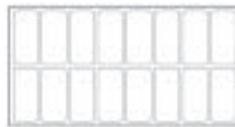

	1590 x 1195 x 1335
	1410 x 770 x 653
	230 V
	630 - 16x5 L
	-22/-15°C
	R 290
	195

SCHEPIJSVITRINE

- LED verlichting
- Statische vriezer
- Digitale display
- Automatische ontdooiing
- Vzv schuifruit
- Onderkoeling / opslag
- Incl. schepijslepel wasbak
- Verrijdbaar

SPEISEISVITRINE

- LED Beleuchtung
- Statische Kühlung
- Digitalanzeige
- Automatische Abtauung
- Glasschiebedeckel
- Kühlung unten / Lager
- Inklusive Becken für Eislöffel
- Auf Räder

ICE CREAM DISPLAY

- LED Lighting
- Static freezer
- Digital display
- Automatic defrost
- Sliding glass lid
- Cooling below / storage
- Incl. scoop sink for ice cream
- Mobile

VITRINE À CREME GLACÉE

- Éclairage LED
- Congélateur statique
- Affichage numérique
- Dégivrage automatique
- Equipé de vitre coulissante
- Refroidissement en dessous / stockage
- Incl. Cuillère à glace évier
- Mobile

7476.0225 € 22,-



Ice cream tray



ICE CREAM DISPLAY

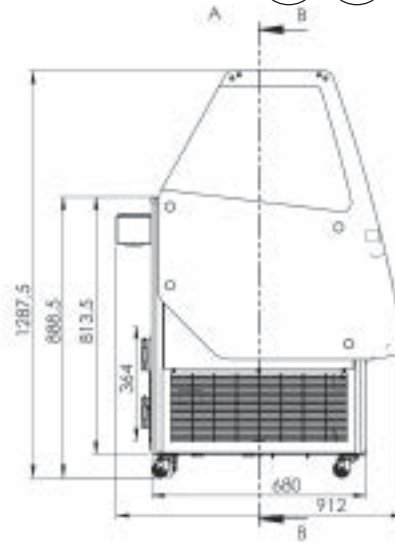

Cooking range

Drop-in

Ovens

Kitchen equipment

7472.0140

€ 2.520,-



IBIZA

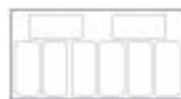

7472.0145

€ 2.975,-



CUBA



Refrigeration

Dishwashers

	1194 x 842 x 1285	1664 x 842 x 1285
	1060 x 560 x 688	1530 x 560 x 688
	230 V / 0,15 kW	230 V / 0,19 kW
	358 - 8x5 L	540 - 13x5 L
	-24/-14°C	-24/-14°C
	R 290	R 290
	130	150

Neutral

Faucets

SCHEPIJSVITRINE

- LED verlichting
- Statische vriezer
- Digitale display
- Automatische ontdooiing
- Vzv schuifruit
- Onderkoeling / opslag
- Incl. schepijslepel wasbak
- Verrijdbaar

SPEISEISVITRINE

- LED Beleuchtung
- Statische Kühlung
- Digitalanzeige
- Automatische Abtauung
- Glasschiebedeckel
- Kühlung unten / Lager
- Inklusive Becken für Eislöffel
- Auf Räder

ICE CREAM DISPLAY

- LED Lighting
- Static freezer
- Digital display
- Automatic defrost
- Sliding glass lid
- Cooling below / storage
- Incl. scoop sink for ice cream
- Mobile

VITRINE À CREME GLACÉE

- Éclairage LED
- Congélateur statique
- Affichage numérique
- Dégivrage automatique
- Equipé de vitre coulissante
- Refroidissement en dessous / stockage
- Incl. Cuillère à glace évier
- Mobile

Ventilation

Pizzeria

7476.0225

€ 22,-



Ice cream tray

Bakery



Refrigeration

ICE CREAM DISPLAY



Refrigerators & Freezer Cabinets

Refrigerated & Freezer Counters

Saladettes

Coldrooms

Chest Freezers

Display Refrigeration

Ice Machines



7151.0005

€ 1.150,-



CAPRI



1043 x 659 x 1315

915 x 529 x 552/658

230 V / 0,13 kW

278 - 5 x 5 L

-24/-18°C

R 290

68

7151.0010

€ 1.330,-



FLORES



1318 x 659 x 1315

1190 x 529 x 552/658

230 V / 0,15 kW

371 - 7 x 5 L

-24/-18°C

R 290

79

7151.0015

€ 1.640,-



MADEIRA



1494 x 659 x 1315

1366 x 529 x 552/658

230 V / 0,19 kW

432 - 8 x 5 L

-24/-18°C

R 290

90

SCHEPIJSVITRINE

- LED verlichting
- Statische vriezer
- Omgevingstemperatuur +35°C
- Isolatie 61 mm
- Vzv schuifruit
- Verrijdbaar

SPEISEISVITRINE

- LED Beleuchtung
- Statische Kühlung
- Umgebungstemperatur +35°C
- Isolierschicht 61 mm
- Glasschiebdeckel
- Auf Räder

ICE CREAM DISPLAY

- LED Lighting
- Static freezer
- Ambient temp. +35°C
- Insulation 61 mm
- Sliding glass lid
- Mobile

VITRINE À CREME GLACÉE

- Éclairage LED
- Congélateur statique
- Temp. ambiente +35°C
- Isolation 61 mm
- Equipé de vitre coulissante
- Mobile

7476.0225

€ 22,-



Ice cream tray



ICE CREAM DISPLAY

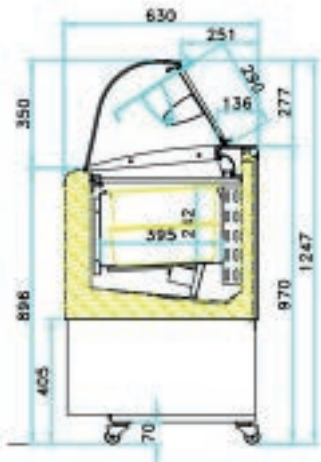

Cooking range

Drop-in

Ovens

Kitchen equipment

7295.0005

€ 3.330,-



7295.0010

€ 3.825,-



7295.0015

€ 4.055,-



FIJI

	824 x 630 x 1247	1214 x 630 x 1247	1354 x 630 x 1247
	230 V / 0,555 kW	230 V / 0,9 kW	230 V / 0,9 kW
	4+4 x 5 L	6+6 x 5 L	7+7 x 5 L
	-14/-16°C	-14/-16°C	-14/-16°C
	R 290	R 290	R 290
	94	116	125

Refrigeration

Dishwashers

Neutral

Faucets

SCHEPIJSVITRINE

- LED verlichting
- Geventileerd koelsysteem
- Automatische ontdooiing
- Omgevingstemperatuur +35°C
- Verrijdbaar
- Ruimte voor een opgestapelde rij ijsbakken

SPEISEISVITRINE

- LED Beleuchtung
- Umluft Kühlung
- Automatische Abtaugung
- Umgebungstemperatur +35°C
- Auf Räder
- Doppelreihige Anordnung der Eisschalen möglich

ICE CREAM DISPLAY

- LED lighting
- Fan cooling system
- Automatic defrost
- Ambient temperature +35°C
- Mobile
- Space for a stacked row of ice cream trays

VITRINE À CREME GLACÉE

- Éclairage LED
- Système de refroidissement par ventilateur
- Dégivrage automatique
- Temp. ambiante +35°C
- Mobile
- Espace pour une rangée empilée de bacs à glace

Ventilation

Pizzeria

Bakery

7476.0225



€ 22,-



Ice cream tray



Refrigeration

Refrigerators & Freezer Cabinets

Refrigerated & Freezer Counters

Saladettes

Coldrooms

Chest Freezers

Display Refrigeration

Ice Machines

ICE CREAM DISPLAY

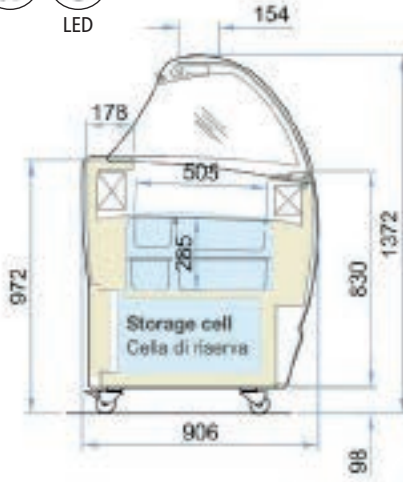

7295.0020

€ 6.440,-



7295.0025

€ 7.480,-



ISABELLA

	1317 x 906 x 1372	1647 x 906 x 1372
	230 V / 0,59 kW	230 V / 0,98 kW
	520 - 10+10x5 L	660 - 13+13x5 L
	-14/-16°C	-14/-16°C
	R 290	R 290
	180	231

SCHEPIJSVITRINE

- LED verlichting
- Statische vriezer
- Automatische ontdooing
- Omgevingstemperatuur +30°C
- Verrijdbaar
- Ruimte voor een opgestapelde rij ijsbakken
- Onderkoeling / opslag

SPEISEISVITRINE

- LED Beleuchtung
- Statische Tiefkühlung
- Automatische Abtauung
- Umgebungstemperatur +30°C
- Auf Räder
- Doppelreihige Anordnung der Eisschalen möglich
- Kühlung unten / Lager

ICE CREAM DISPLAY

- LED lighting
- Static freezer
- Automatic defrost
- Ambient temperature +30°C
- Mobile
- Space for a stacked row of ice cream trays
- Cooling below / storage

VITRINE À CREME GLACÉE

- Éclairage LED
- Congélateur statique
- Dégivrage automatique
- Temp. ambiante +30°C
- Mobile
- Espace pour une rangée empilée de bacs à glace
- Refroidissement en dessous / stockage

7295.9005 € 1.020,-



Sink for ice cream scoop

7476.0225 € 22,-



Ice cream tray



ICE CREAM DISPLAY



Cooking range

Drop-in

Ovens

Kitchen equipment

7295.0030

€ 7.965,-



7295.0035

€ 9.050,-



BERMUDA

	1340 x 799 x 1343	1670 x 799 x 1343
	230 V / 0,77 kW	230 V / 1,34 kW
	300 - 10x5 L	395 - 13x5 L
	-14/-16°C	-14/-16°C
	R 290	R 290
	215	225

Refrigeration

Dishwashers

Neutral

Faucets

SCHEPIJSVITRINE

- LED verlichting
- Geventileerd koelsysteem
- Automatische ontdooiing
- Omgevingstemperatuur +30°C
- Verrijdbaar
- Onderkoeling / opslag

SPEISEISVITRINE

- LED Beleuchtung
- Umluft Kühlung
- Automatische Abtauung
- Umgebungstemperatur +30°C
- Auf Räder
- Kühlung unten / Lager

ICE CREAM DISPLAY

- LED lighting
- Fan cooling system
- Automatic defrost
- Ambient temperature +30°C
- Mobile
- Cooling below / storage

VITRINE À CREME GLACÉE

- Éclairage LED
- Système de refroidissement par ventilateur
- Dégivrage automatique
- Temp. ambiente +30°C
- Mobile
- Refroidissement en dessous / stockage

Ventilation

Pizzeria

Bakery

7476.0225

€ 22,-



Ice cream tray



Refrigeration

ICE CREAM DISPLAY



60 mm

LED

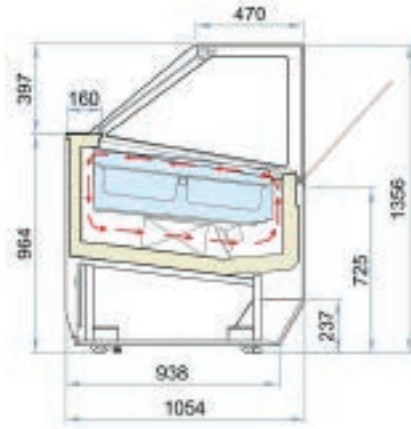

Refrigerators & Freezer Cabinets

Refrigerated & Freezer Counters

Saladettes

Coldrooms

Chest Freezers

Display Refrigeration

Ice Machines

7295.0040

€ 18.155,-



7295.0045

€ 19.415,-



7295.0050 *

€ 22.055,-



7295.0055 *

€ 24.555,-



7295.0060 *

€ 26.235,-



MILLENIUM

	1166 x 1054 x 1356	1496 x 1054 x 1356	1661 x 1054 x 1356	1826 x 1054 x 1356	2156 x 1054 x 1356
	230 V / 1,5 kW	230 V / 1,69 kW	230 V / 1,8 kW	230 V / 1,89 kW	230 V / 1,99 kW
	630 - 12x5 L	870 - 16x5 L	970 - 18x5 L	1080 - 20x5 L	1300 - 24x5 L
	-14/-16°C	-14/-16°C	-14/-16°C	-14/-16°C	-14/-16°C
	R 290	R 290	R 290	R 290	R 290
	261	359	361	380	505

(*) EXPORT TRANSPORTKOSTEN OP AANVRAAG | TRANSPORTKOSTEN AUF ANFRAGE | TRANSPORT COSTS ON REQUEST | FRAIS DE TRANSPORT SUR DEMANDE

SCHEPIJSVITRINE

- LED verlichting
- Geventileerd koelsysteem
- Automatische ontdooiing
- Omgevingstemperatuur +30°C
- Met nachtabdekking aan de bedieningszijde

SPEISEISVITRINE

- LED Beleuchtung
- Umluft Kühlung
- Automatische Abtauung
- Umgebungstemperatur +30°C
- Mit Nachtabdeckung auf der Bedienung Seite

ICE CREAM DISPLAY

- LED lighting
- Fan cooling system
- Automatic defrost
- Ambient temperature +30°C
- With night cover on the operating side

VITRINE À CREME GLACÉE

- LED lighting
- Fan cooling system
- Automatic defrost
- Ambient temperature +30°C
- With night cover on the operating side

7476.0225 € 22,-



Ice cream tray



ICE CREAM DISPLAY

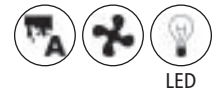

Cooking range

Drop-in

Ovens

Kitchen equipment

Refrigeration

Dishwashers

Neutral

Faucets

Ventilation

Pizzeria

Bakery

7295.0065

€ 12.985,-



CARRETTINO



	2000 x 1285 x 2081
	230 V / 0,47 kW
	6+6 x 5 L
	-14/-16°C
	R 290
	231

SCHEPIJSVITRINE

- LED verlichting
- Geventileerd koelsysteem
- Automatische ontthooing
- Omgevingstemperatuur +30°C
- Verrijdbaar
- Ruimte voor een opgestapelde rij ijsbakken
- Incl. spoelbak voor schepijslepel met waterkraan en watertanks
- RVS werkblad

SPEISEISVITRINE

- LED Beleuchtung
- Umluft Kühlung
- Automatische Abtaung
- Umgebungstemperatur +30°C
- Auf Räder
- Doppelreihige Anordnung der Eisschalen möglich
- Inklusiv Waschbecken für Eislöffel mit Wasserhahn und Wassertanks
- Edelstahl Arbeitsplatte

ICE CREAM DISPLAY

- LED lighting
- Fan cooling system
- Automatic defrost
- Ambient temperature +30°C
- Mobile
- Space for a stacked row of ice cream trays
- Incl. scoop washer with water tap and tanks for water
- Stainless steel worktop

VITRINE À CREME GLACÉE

- Éclairage LED
- Système de refroidissement par ventilateur
- Dégivrage automatique
- Temp. ambiente +30°C
- Mobile
- Espace pour une rangée empilée de bacs à glace
- Incl. cuillère à glace évier et avec robinet d'eau et réservoirs d'eau
- Plan de travail en acier inoxydable

7476.0225

€ 22,-



Ice cream tray



Refrigeration

GRAB-AND-GO BEVERAGE COOLER

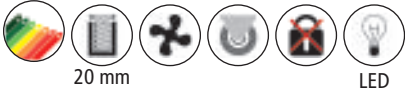

Refrigerators & Freezer Cabinets

Refrigerated & Freezer Counters

Saladettes

Coldrooms

Chest Freezers

Display Refrigeration

Ice Machines

7464.0300

€ 1.564,-



7464.0305

€ 1.899,-



7464.0310

€ 1.480,-



	655 x 570 x 1132	655 x 575 x 1498	655 x 424 x 986
	-	601 x 495 x 907	599 x 286 x 428
	230 V / 0,42 kW	230 V / 0,6 kW	230 V / 0,35 kW
	210 L	274 L	110 L
	+2/+15°C	+2/+15°C	+2/+15°C
	R 290	R 290	R 290
	manual	automatic	manual
	84	100	59

IMPULSKOELER OPEN

- LED verlichting
- Isolatie 20 mm
- 7464.0300-0305: Omgevingstemp. +25°C
- 7464.0310: Omgevingstemp. +32°C
- Geforceerde koeling
- Automatische ontdooiing
- Zelfbediening middels open voorzijde

IMPULSKÜHLER

- LED Beleuchtung
- Isolierschicht 20 mm
- 7464.0300-0305: Umgebungstemp. +25°C
- 7464.0310: Umgebungstemp. +32°C
- Umluft Kühlung
- Automatische Abtauung
- Selbstbedienung durch offene Front

GRAB-AND-GO BEVERAGE COOLER

- LED lighting
- Insulation 20mm
- 7464.0300-0305: Ambient temp. +25°C
- 7464.0310: Ambient temp. +32°C
- Ventilated cooling
- Automatic defrost
- Self-service through open front

VITRINE LIBRE-SERVICE

- Éclairage LED
- Isolation 20 mm
- 7464.0300-0305: Temp. ambiante. +25°C
- 7464.0310: Temp. ambiante. +32°C
- Froid renforcé
- Dégivrage automatique
- Libre-service grâce à la façade ouverte



GRAB-AND-GO BEVERAGE COOLER



7464.0315

€ 2.110,-

7464.0320

€ 2.290,-

	630 x 630 x 1575	730 x 742 x 1850
	520 x 300 x 831	620 x 402 x 1103
	230 V / 0,38 kW	230 V / 0,78 kW
	127 L	274 L
	+2/+15°C	+2/+15°C
	R 290	R 290
dB	63	64
	101	136

IMPULSKOELER OPEN

- LED verlichting
- Isolatie 50mm
- Omgevingstemp. +25°C
- Geforceerde koeling
- Automatische ontdooiing
- Zelfbediening middels open voorzijde
- Met nachtafdekking

IMPULSKÜHLER

- LED Beleuchtung
- Isolierschicht 50 mm
- Umgebungstemp. +25°C
- Umluft Kühlung
- Automatische Abtaugung
- Selbstbedienung durch offene Front
- Mit Nachtabdeckung

GRAB-AND-GO BEVERAGE COOLER

- LED lighting
- Insulation 50 mm
- Ambient temp. +25°C
- Ventilated cooling
- Automatic defrost
- Self-service through open front
- With night cover

VITRINE LIBRE-SERVICE

- Éclairage LED
- Isolation 50 mm
- Temp. ambiente +25°C
- Froid renforcé
- Dégivrage automatique
- Libre-service grâce à la façade ouverte
- Avec couverture de nuit

Cooking range

Drop-in

Ovens

Kitchen equipment

Refrigeration

Dishwashers

Neutral

Faucets

Ventilation

Pizzeria

Bakery



Refrigeration

COOLING ISLAND



33 mm



Refrigerators & Freezer Cabinets

Refrigerated & Freezer Counters

Saladettes

Coldrooms

Chest Freezers

Display Refrigeration

Ice Machines

7090.0020

€ 3.495,-



7090.0025

€ 3.790,-



	1370 x 1080 x 935	1370 x 1080 x 935
	230 V / 0,23 kW	230 V / 0,55 kW
	190 L	190 L
	0/+6°C	0/+6°C
	R 290	R 290
	166	185

KOELEILAND

- Isolatie 33 mm
- Omgevingstemp. +25°C
- Geforceerde koeling
- Automatische ontdooiing

KÜHLINSEL

- Isolierschicht 33 mm
- Umgebungstemp. +25°C
- Umluft Kühlung
- Automatische Abtauung

COOLING ISLAND

- Insulation 33mm
- Ambient temp. +25°C
- Ventilated cooling
- Automatic defrost

ÎLOT DE REFROIDISSEMENT

- Isolation 33 mm
- Temp. ambiente +25°C
- Froid renforcé
- Dégivrage automatique



COOLING ISLAND



LED 65 mm



7090.0030

€ 1.820,-



	772 x 833 x 930
	230 V / 0,55 kW
	87 L
	+2/+8°C
	R 290
	115

KOELEILAND

- Isolatie 65 mm
- Omgevingstemp. +25°C
- Geforceerde koeling
- Automatische ontdooiing

KÜHLINSEL

- Isolierschicht 65 mm
- Umgebungstemp. +25°C
- Umluft Kühlung
- Automatische Abtauung

COOLING ISLAND

- Insulation 65 mm
- Ambient temp. +25°C
- Ventilated cooling
- Automatic defrost

ÎLOT DE REFROIDISSEMENT

- Isolation 65 mm
- Temp. ambiente +25°C
- Froid renforcé
- Dégivrage automatique

Cooking range

Drop-in

Ovens

Kitchen equipment

Refrigeration

Dishwashers

Neutral

Faucets

Ventilation

Pizzeria

Bakery



Refrigeration

COOLING/FREEZING ISLAND SWITCHABLE



50 mm



Refrigerators & Freezer Cabinets

Refrigerated & Freezer Counters

Saladettes

Coldrooms

Chest Freezers

Display Refrigeration

Ice Machines

7090.0055

€ 3.455,-



	1530 x 995 x 950
	230 V / 1,2 kW
	260 L
	0/+6°C -15/-18°C
	R 290
	194

KOEL- / VRIESEILAND OMSCHAKELBAAR

- Door schakelaar te wisselen tussen koeler en vriezer
- Isolatie 50 mm
- Omgevingstemp. +25°C
- Geforceerde koeling
- Automatische ontdooiing

KÜHL / TIEFKÜHLINSEL UMSCHALTBAR

- Per Schalter zwischen Kühl- und Gefrierschrank umschaltbar
- Isolierschicht 50 mm
- Umgebungstemp. +25°C
- Umluft Kühlung
- Automatische Abtaugung

COOLING / FREEZING ISLAND SWITCHABLE

- Interchangeable between cooler and freezer
- Insulation 50 mm
- Ambient temp. +25°C
- Ventilated cooling
- Automatic defrost

ÎLOT DE REFROIDISSEMENT/ CONGELATION COMMUTABLE

- Interchangeable entre réfrigérateur et congélateur par interrupteur
- Isolation 50 mm
- Temp. ambiente +25°C
- Froid renforcé
- Dégivrage automatique



COOLING / FREEZING ISLAND SWITCHABLE

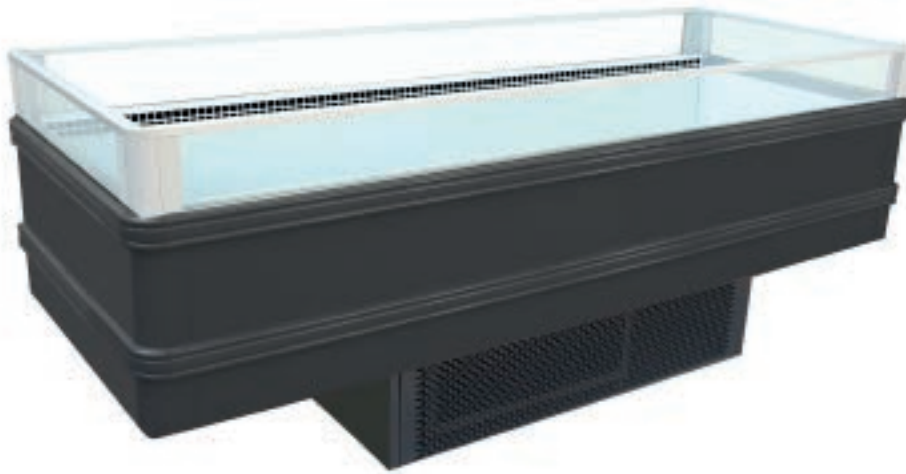

Cooking range

Drop-in

Ovens

Kitchen equipment

Refrigeration

Dishwashers

Neutral

Faucets

Ventilation

Pizzeria

Bakery

7080.0020

€ 4.340,-



7080.0025

€ 5.065,-



	1530 x 995 x 950	2030 x 995 x 950
	230 V / 1,2 kW	230 V / 1,62 kW
	240 L	320 L
	0/+6°C -16/-22°C	0/+6°C -16/-22°C
	R 290	R 290
	220	250

**KOEL-/VRIESEILAND
OMSCHAKELBAAR**

- Door schakelaar te wisselen tussen koelkast en diepvriezer
- Geventileerd koelsysteem
- Digitale thermostaat
- Automatische ontthooing
- Omgevingstemperatuur +25°C

**KÜHL-/TIEFKÜHLINSEL
UMSCHALTBAR**

- Per Schalter zwischen Kühl- und Gefrierschrank umschaltbar
- Umluft Kühlung
- Digitales Thermostat
- Automatische Abtauung
- Umgebungstemperatur +25°C

**COOLING / FREEZING
ISLAND SWITCHABLE**

- Interchangeable between fridge and freezer by switch
- Fan cooling system
- Digital thermostat
- Automatic defrost
- Ambient temperature +25°C

**ÎLOT DE REFRIGÉRISSÉMENT / CONGÉLATION
COMMUTABLE**

- Interchangeable entre réfrigérateur et congélateur par interrupteur
- Système de refroidissement par ventilateur
- Thermostat numérique
- Dégivrage automatique
- Temp. ambiante +25°C

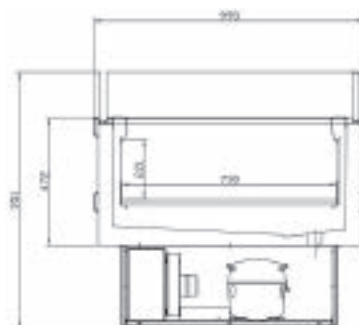



Refrigeration

COOLING / FREEZING ISLAND SWITCHABLE

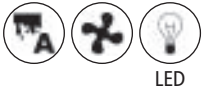

Refrigerators & Freezer Cabinets

Refrigerated & Freezer Counters

Saladettes

Coldrooms

Chest Freezers

Display Refrigeration

Ice Machines



7295.0080



7295.0085 | 7295.0090

7295.0080	7295.0085	7295.0090
€ 3.790,-	€ 5.075,-	€ 5.530,-

	EXPO	ACTION	
	560 x 750 x 870	760 x 820 x 870	1060 x 820 x 870
	230 V / 0,4 kW	230 V / 0,62 kW	230 V / 1 kW
	143 L	160 L	238 L
	+1/+5°C -14/-16°C	+1/+5°C -14/-16°C	+1/+5°C -14/-16°C
	R 290	R 290	R 290
	80	110	140

KOEL-/VRIESEILAND OMSCHAKELBAAR

- LED verlichting
- Automatische ontdooiing
- Omgevingstemperatuur +30°C
- Vzv schuifruit
- Door schakelaar te wisselen tussen koeler en diepvriezer

KÜHL-/TIEFKÜHLINSEL UMSCHALTBAR

- LED Beleuchtung
- Automatische Abtauung
- Umgebungstemperatur +30°C
- Glasschiebdeckel
- Per Schalter zwischen Kühl- und Gefrierschrank umschaltbar

COOLING / FREEZING ISLAND SWITCHABLE

- LED lighting
- Automatic defrost
- Ambient temperature +30°C
- Sliding glass lid
- Interchangeable between cooler and freezer by switch

ÎLOT DE REFRIGÉRISSMENT / CONGÉLATEUR COMMUTABLEE

- Éclairage LED
- Dégivrage automatique
- Temp. ambiante +30°C
- Equipé de vitre coulissante
- Interchangeable entre réfrigérateur et congélateur par interrupteur

7476.0225 € 22,-

Ice cream tray



COLD DISPLAY

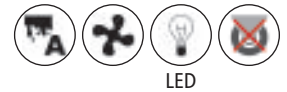

LED



7455.2700

€ 2.990,-



	1935 x 1180 x 900
	230 V / 0,89 kW
	-1/+7°C
	R600a
	259 L
	225

KOELVITRINE

- LED verlichting
- Geventileerd koelsysteem
- Max. omgevingtemp. 25°C / 60% RH
- No frost
- Digitale display
- Binnenzijde gecoat
- Isolatie 40 mm.
- Dikte glas voorzijde 5 mm

KÜHLVITRINE

- LED Beleuchtung
- Umluft Kühlung
- Max. Umgebungstemperatur 25°C / 60% RH
- Keinen Frost
- Digitalanzeige
- Innenseite beschichtet
- Isolierschicht 40 mm
- Glass Vorderseite 5 mm

COLD DISPLAY

- LED lighting
- Fan cooling system
- Max. ambient: 25°C / 60% RH
- No frost
- Digital display
- Internal interior coated
- Foaming thickness 40mm
- Front glass thickness 5 mm

VITRINE RÉFRIGÉRÉE

- Éclairage LED
- Système de refroidissement par ventilateur
- Temp. ambiente 25°C / 60% RH
- Pas de gel
- Affichage numérique
- Intérieur revêtu
- Épaisseur moussante 40 mm
- Épaisseur du verre frontal 5 mm

Cooking range

Drop-in

Ovens

Kitchen equipment

Refrigeration

Dishwashers

Neutral

Faucets

Ventilation

Pizzeria

Bakery



Refrigeration

COLD DISPLAY



Refrigerators & Freezer Cabinets

Refrigerated & Freezer Counters

Saladettes

Coldrooms

Chest Freezers

Display Refrigeration

Ice Machines



7486.0005

€ 2.670,-



7486.0010

€ 3.100,-



7486.0015 (*)

€ 3.450,-



VINNIE

	1500 x 825 x 1230	2000 x 825 x 1230	2490 x 825 x 1230
	230 V / 0,63 kW	230 V / 0,83 kW	230 V / 0,83 kW
	+1/+10°C	+1/+10°C	+1/+10°C
	R 290	R 290	R 290
	175	225	275

(*) EXPORT TRANSPORTKOSTEN OP AANVRAAG | TRANSPORTKOSTEN AUF ANFRAGE | TRANSPORT COSTS ON REQUEST | FRAIS DE TRANSPORT SUR DEMANDE

KOELVITRINE

- LED verlichting
- Statische koeler
- Displayruimte en onderkoeling van RVS
- Behuizing wit/zwart gepoedercoat
- Roestvrijstaal werkblad
- Digitale display
- Incl. nachtafdekking
- Met snack etage

KÜHLVITRINE

- LED Beleuchtung
- Statische Kühlung
- Anzeigefläche und Lagerraum Edelstahl
- Gehäuse weiß/schwarz pulverbeschichtet
- Edelstahl Arbeitsplatte
- Digitalanzeige
- Inkl. Nachtdeckung
- Mit Zwischenglass

COLD DISPLAY

- LED lighting
- Static cooling
- Display area and storage chamber made of stainless steel
- White/black powder coated
- Stainless steel worktop
- Digital display
- Night plexi glass cover
- Incl. "snack" shelf

VITRINE RÉFRIGÉRÉE

- Éclairage LED
- Froid statique
- Zone d'affichage et espace de stockage en acier inoxydable
- Laqué blanc/noir
- Stainless steel worktop
- Affichage numérique
- Couverture en plexiglas de nuit
- Incl. étagère "snack"

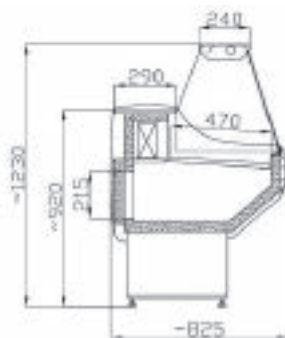



COLD DISPLAY



Cooking range

Drop-in

Ovens

Kitchen equipment

Refrigeration

Dishwashers

Neutral

Faucets

Ventilation

Pizzeria

Bakery



7486.0055

€ 3.595,-



7486.0060

€ 4.200,-



7486.0065 (*)

€ 4.750,-



OSCAR

	1584 x 815 x 1280	1959 x 815 x 1280	2584 x 815 x 1280
	230 V / 0,63 kW	230 V / 0,83 kW	230 V / 0,83 kW
	+1/+10°C	+1/+10°C	+1/+10°C
	R 290	R 290	R 290
	135	166	190

(*) EXPORT TRANSPORTKOSTEN OP AANVRAAG | TRANSPORTKOSTEN AUF ANFRAGE | TRANSPORT COSTS ON REQUEST | FRAIS DE TRANSPORT SUR DEMANDE

KOELVITRINE

- LED verlichting
- Statische koeler
- Displayruimte en onderkoeling van RVS
- Behuizing wit/zwart gepoedercoat
- Roestvrijstaal werkblad
- Digitale display
- Incl. nachtabdekking
- Met snack etage

KÜHLVITRINE

- LED Beleuchtung
- Statische Kühlung
- Anzeigefläche und Lagerraum Edelstahl
- Gehäuse weiß/schwarz pulverbeschichtet
- Edelstahl Arbeitsplatte
- Digitalanzeige
- Inkl. Nachtdeckung
- Mit Zwischenglass

COLD DISPLAY

- LED lighting
- Static cooling
- Display area and storage chamber made of stainless steel
- White/black powder coated
- Stainless steel worktop
- Digital display
- Night plexi glas cover
- Incl. "snack" shelf

VITRINE RÉFRIGÉRÉE

- Éclairage LED
- Froid statique
- Zone d'affichage et espace de stockage en acier inoxydable
- Laqué blanc/noir
- Stainless steel worktop
- Affichage numérique
- Couverture en plexiglas de nuit
- Incl. étagère "snack"

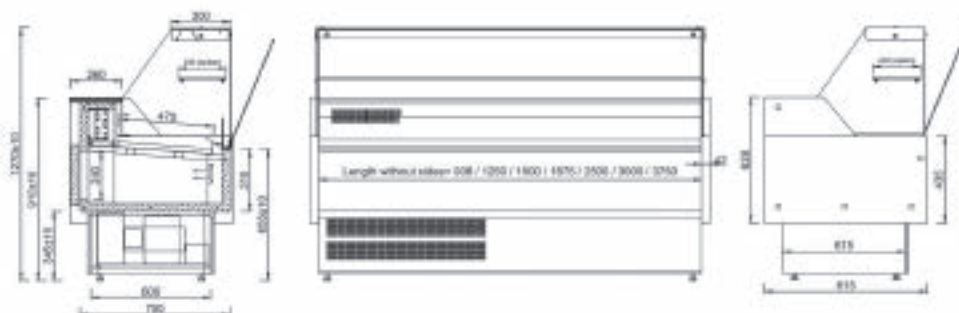



Refrigeration

Refrigerators & Freezer Cabinets

Refrigerated & Freezer Counters

Saladettes

Coldrooms

Chest Freezers

Display Refrigeration

Ice Machines

COLD DISPLAY



7486.0020	7486.0025	7486.0030 (*)	7486.0035 (*)
€ 3.350,-	€ 3.720,-	€ 4.510,-	€ 5.490,-

OWEN

	1500 x 1060 x 1310	2000 x 1060 x 1310	2490 x 1060 x 1310	2940 x 1060 x 1310
	230 V / 0,63 kW	230 V / 0,84 kW	230 V / 1 kW	230 V / 1,3 kW
	+1/+10°C	+1/+10°C	+1/+10°C	+1/+10°C
	R 290	R 290	R 290	R 290
	225	250	350	375

(*) EXPORT TRANSPORTKOSTEN OP AANVRAAG | TRANSPORTKOSTEN AUF ANFRAGE | TRANSPORT COSTS ON REQUEST | FRAIS DE TRANSPORT SUR DEMANDE

KOELVITRINE

- LED verlichting
- Statische koeler
- Displayruimte en onderkoeling van RVS
- Behuizing wit/zwart gepoedercoat
- Roestvrijstaal werkblad
- Digitale display
- Incl. nachtafdekking
- Met snack etage

KÜHLVITRINE

- LED Beleuchtung
- Statische Kühlung
- Anzeigefläche und Lagerraum Edelstahl
- Gehäuse weiß/schwarz pulverbeschichtet
- Edelstahl Arbeitsplatte
- Digitalanzeige
- Inkl. Nachtdeckung
- Mit Zwischenglass

COLD DISPLAY

- LED lighting
- Static cooling
- Display area and storage chamber made of stainless steel
- White/black powder coated
- Stainless steel worktop
- Digital display
- Night plexi glass cover
- Incl. "snack" shelf

VITRINE RÉFRIGÉRÉE

- Éclairage LED
- Froid statique
- Zone d'affichage et espace de stockage en acier inoxydable
- Laqué blanc/noir
- Stainless steel worktop
- Affichage numérique
- Couverture en plexiglas de nuit
- Incl. étagère "snack"

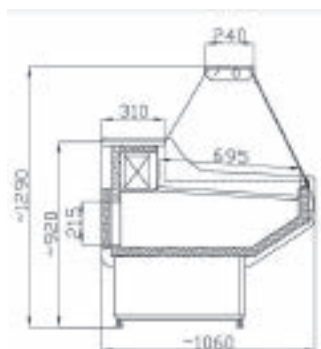



COLD DISPLAY



Cooking range

Drop-in

Ovens

Kitchen equipment



7486.0070	7486.0075	7486.0080 (*)	7486.0085 (*)
€ 3.760,-	€ 4.250,-	€ 4.960,-	€ 5.980,-

MORRIS

	1584 x 1095 x 1280	1959 x 1095 x 1280	2584 x 1095 x 1280	3084 x 1095 x 1280
	230 V / 0,63 kW	230 V / 0,84 kW	230 V / 1 kW	230 V / 1,3 kW
	+1/+10°C	+1/+10°C	+1/+10°C	+1/+10°C
	R 290	R 290	R 290	R 290
	155	192	250	300

(*) EXPORT TRANSPORTKOSTEN OP AANVRAAG | TRANSPORTKOSTEN AUF ANFRAGE | TRANSPORT COSTS ON REQUEST | FRAIS DE TRANSPORT SUR DEMANDE

KOELVITRINE

- LED verlichting
- Statische koeler
- Displayruimte en onderkoeling van RVS
- Behuizing wit/zwart gepoedercoat
- Roestvrijstaal werkblad
- Digitale display
- Incl. nachtabdekking
- Met snack etage

KÜHLVITRINE

- LED Beleuchtung
- Statische Kühlung
- Anzeigefläche und Lagerraum Edelstahl
- Gehäuse weiß/schwarz pulverbeschichtet
- Edelstahl Arbeitsplatte
- Digitalanzeige
- Inkl. Nachtdeckung
- Mit Zwischenglass

COLD DISPLAY

- LED lighting
- Static cooling
- Display area and storage chamber made of stainless steel
- White/black powder coated
- Stainless steel worktop
- Digital display
- Night plexi glas cover
- Incl. "snack" shelf

VITRINE RÉFRIGÉRÉE

- Éclairage LED
- Froid statique
- Zone d'affichage et espace de stockage en acier inoxydable
- Laqué blanc/noir
- Stainless steel worktop
- Affichage numérique
- Couverture en plexiglas de nuit
- Incl. étagère "snack"

Refrigeration

Dishwashers

Neutral

Faucets

Ventilation

Pizzeria

Bakery

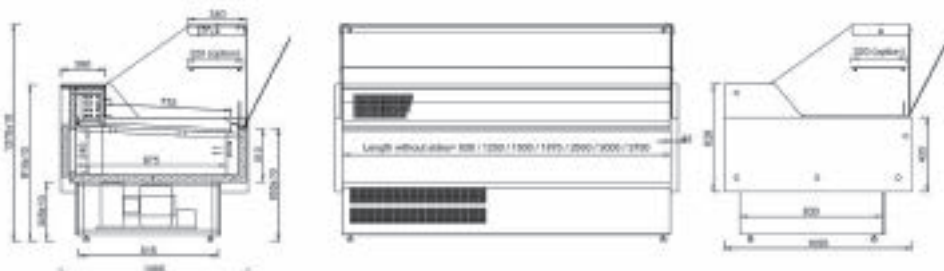



Refrigeration

Refrigerators & Freezer Cabinets

Refrigerated & Freezer Counters

Saladettes

Coldrooms

Chest Freezers

Display Refrigeration

Ice Machines

REFRIGERATED BUFFET

GEKOELD BUFFET

GEKÜHLTES BÜFFET

REFRIGERATED BUFFET

BUFFET REFRIGÉRÉE

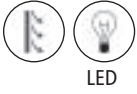

LED



7077.0005

7077.0010

7077.0015

€ 2.215,-

€ 2.440,-

€ 3.135,-



1200 x 900 x 850/1350

1550 x 900 x 850/1350

2200 x 900 x 850/1350



230 V / 0,398 kW

230 V / 0,507 kW

230 V / 0,507 kW



0/+10°C

0/+10°C

0/+10°C



R 290

R 290

R 290

GN

3/1 GN

4/1 GN

6/1 GN



165

180

235

HOT BUFFET

WARM BUFFET

HEISSES BÜFFET

HOT BUFFET

BUFFET CHAUD



LED



7077.0020

7077.0025

7077.0030

€ 2.050,-

€ 2.295,-

€ 2.915,-



1200 x 900 x 850/1350

1550 x 900 x 850/1350

2200 x 900 x 850/1350



230 V / 2 kW

230 V / 3 kW

230 V / 4 kW



+30/+90°C

+30/+90°C

+30/+90°C

GN

3/1 GN

4/1 GN

6/1 GN



130

155

220



GEKOELD BUFFET WENGE

GEKÜHLTES BÜFFET WENGE

REFRIGERATED BUFFET WENGE

BUFFET RÉFRIGÉRÉE WENGE

REFRIGERATED BUFFET WENGE



7077.0100

€ 2.695,-



7077.0105

€ 3.255,-



7077.0110

€ 3.930,-



	1070 x 800 x 850/1350	1400 x 800 x 850/1350	1800 x 800 x 850/1350
	230 V / 0,398 kW	230 V / 0,507 kW	230 V / 0,507 kW
	0/+10°C	0/+10°C	0/+10°C
	R 290	R 290	R 290
GN	3/1 GN	4/1 GN	5/1 GN
	210	230	290

HOT BUFFET WENGE

WARM BUFFET WENGE

HEISSES BÜFFET WENGE

CASH DECK WENGE

KASSA ELEMENT WENGE

KASSENELEMENT WENGE

HOT BUFFET WENGE

BUFFET CHAUD WENGE

CASH DECK WENGE

ÉLÉMENT CAISSE WENGE



LED



7077.0115

€ 2.115,-



7077.0120

€ 2.440,-



7077.0125

€ 1.225,-



	1070 x 800 x 850/1350	1400 x 800 x 850/1350		800 x 800 x 850
	230 V / 2,02 kW	230 V / 3,02 kW		130
	+30/+90°C	+30/+90°C		
GN	3/1 GN	4/1 GN		
	155	190		

Cooking range

Drop-in

Ovens

Kitchen equipment

Refrigeration

Dishwashers

Neutral

Faucets

Ventilation

Pizzeria

Bakery



Refrigeration

Refrigerators & Freezer Cabinets

Refrigerated & Freezer Counters

Saladettes

Coldrooms

Chest Freezers

Display Refrigeration

Ice Machines

COLD DISPLAY

KOELVITRINE

KÜHLVITRINE

COLD DISPLAY

VITRINE RÉFRIGÉRÉE



	7487.0165	7487.0170	7487.0175	7487.0180
	€ 560,-	€ 560,-	€ 575,-	€ 625,-
	428 x 386 x 885	428 x 386 x 885	428 x 386 x 960	428 x 386 x 1100
	230 V / 0,18 kW	230 V / 0,18 kW	230 V / 0,18 kW	230 V / 0,18 kW
	68 L	68 L	78 L	98 L
	0/+12°C	0/+12°C	0/+12°C	0/+12°C
	R 600 A	R 600 A	R 600 A	R 600 A
	3x	3x	3x	3x
	35	35	36	41

GRIDS		€ 10,-	
		7487.0181	7487.0183
	>	7487.0165	7487.0170-0175-0180

SET CLIPS FOR GRID		€ 10,-	
		7487.0185	7487.0186
	>	7487.0165	7487.0170-0175-0180



KOELVITRINE

KÜHLVITRINE

COLD DISPLAY

VITRINE RÉFRIGÉRÉE



Cooking range

Drop-in

Ovens

Kitchen equipment

Refrigeration

Dishwashers

Neutral

Faucets

Ventilation

Pizzeria

Bakery



7487.0080

€ 975,-



7487.0160

€ 1.115,-



ROTEREND | ROTIERENDE | ROTATING | ROTATIVE

	480 x 480 x 1030	450 x 450 x 983
	230 V / 0,18 kW	230 V / 0,19 kW
	100 L	72 L
	+2/+8°C	0/+10°C
	R 600 A	R 600 A
	3x	4x
	55	55



Refrigeration

Refrigerators & Freezer Cabinets

COLD DISPLAY

KOELVITRINE

KÜHLVITRINE

COLD DISPLAY

VITRINE RÉFRIGÉRÉE



Refrigerated & Freezer Counters

Saladettes

Coldrooms

Chest Freezers

Display Refrigeration

Ice Machines

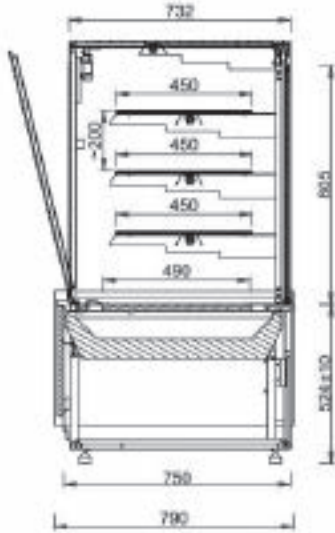

7486.0090

€ 4.720,-



7486.0095

€ 5.370,-



NERO

	937 x 790 x 1400	1437 x 790 x 1400
	230 V / 0,42 kW	230 V / 0,62 kW
	+4/+12°C	+4/+12°C
	R 290	R 290



KOELVITRINE

KÜHLVITRINE

COLD DISPLAY

COLD DISPLAY

VITRINE RÉFRIGÉRÉE

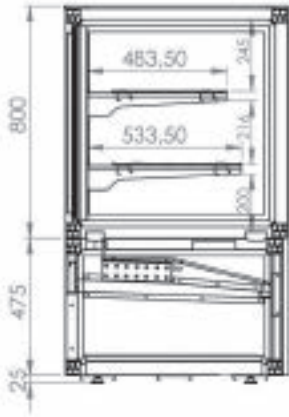
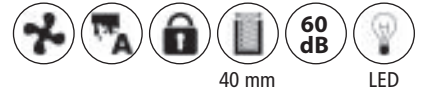

Cooking range

Drop-in

Ovens

Kitchen equipment

Refrigeration

Dishwashers

Neutral

Faucets

Ventilation

Pizzeria

Bakery

	7489.5450	7489.5455	7489.5460	7489.5465	7489.5470
	€ 3.400,-	€ 3.850,-	€ 4.215,-	€ 5.370,-	€ 6.635,-
	800 x 780 x 1300	1000 x 780 x 1300	1200 x 780 x 1300	1600 x 780 x 1300	2000 x 780 x 1300
	230 V / 0,35 kw	230 V / 0,4 kw	230 V / 0,45 kw	230 V / 0,5 kw	230 V / 0,55 kw
	+2/+10°C	+2/+10°C	+2/+10°C	+2/+10°C	+2/+10°C
	300 L	375 L	450 L	600 L	750 L
	R 290	R 290	R 290	R 290	R 290
	100	105	110	115	120



Refrigeration

Refrigerators & Freezer Cabinets

Refrigerated & Freezer Counters

Saladettes

Coldrooms

Chest Freezers

Display Refrigeration

Ice Machines

COLD DISPLAY

KOELVITRINE

KÜHLVITRINE

COLD DISPLAY

VITRINE RÉFRIGÉRÉE



	7487.0015	7487.0020	7487.0025
	€ 2.370,-	€ 2.755,-	€ 3.110,-
	915 x 675 x 1210	1215 x 675 x 1210	1515 x 675 x 1210
	230 V / 0,48 kW	230 V / 0,49 kW	230 V / 0,5 kW
	270 L	370 L	470 L
	+2/+8°C	+2/+8°C	+2/+8°C
	R 290	R 290	R 290
	172	198	224



KOELVITRINE

KÜHLVITRINE

COLD DISPLAY

COLD DISPLAY
 VITRINE RÉFRIGÉRÉE



	7450.0820	7450.0825
	€ 2.815,-	€ 3.250,-
	900 x 680 x 1200	1200 x 680 x 1200
	230 V / 0,33 kW	230 V / 0,34 kW
	190 L	257 L
	+2/+8°C	+2/+8°C
	R 290	R 290
	150	191



	7450.0830	7450.0835
	€ 3.680,-	€ 4.350,-
	1500 x 680 x 1200	2000 x 680 x 1200
	230 V / 0,35 kW	230 V / 0,51 kW
	324 L	436 L
	+2/+8°C	+2/+8°C
	R 290	R 290
	245	360

Cooking range

Drop-in

Ovens

Kitchen equipment

Refrigeration

Dishwashers

Neutral

Faucets

Ventilation

Pizzeria

Bakery



Refrigeration

Refrigerators & Freezer Cabinets

COLD DISPLAY

KOELVITRINE

KÜHLVITRINE

COLD DISPLAY

VITRINE RÉFRIGÉRÉE



Refrigerated & Freezer Counters

Saladettes

Coldrooms

Chest Freezers

Display Refrigeration

Ice Machines



7487.0220

€ 2.460,-



	650 x 805 x 1445
	230 V / 0,46 kW
	300 L
	+2/+8°C
	R 600 A
	LED
	3x
	158

7487.0225

€ 855,-



	685 x 874 x 419
	230 V / 0,11 kW
	128 L
	+2/+12°C
	R 600 A
	X
	1x
	45



KOELVITRINE

KÜHLVITRINE

COLD DISPLAY

COLD DISPLAY
 VITRINE RÉFRIGÉRÉE



	7450.0800	7450.0805
	€ 2.815,-	€ 3.160,-
	900 x 680 x 1200	1200 x 680 x 1200
	230 V / 0,33 kW	230 V / 0,34 kW
	175 L	236 L
	+2/+8°C	+2/+8°C
	R 290	R 290
	150	191



	7450.0810	7450.0815
	€ 3.500,-	4.250,-
	1500 x 680 x 1200	2000 x 680 x 1200
	230 V / 0,35 kW	230 V / 0,51 kW
	298 L	400 L
	+2/+8°C	+2/+8°C
	R 290	R 290
	245	360

Cooking range

Drop-in

Ovens

Kitchen equipment

Refrigeration

Dishwashers

Neutral

Faucets

Ventilation

Pizzeria

Bakery



Refrigeration

Refrigerators & Freezer Cabinets

Refrigerated & Freezer Counters

Saladettes

Coldrooms

Chest Freezers

Display Refrigeration

Ice Machines

DESSERT SHOW DISPLAY

GEBAKSVITRINE

GEBÄCKVITRINE

DESSERT SHOW DISPLAY

VITRINE DE PÂTISSERIE



7450.0600	
€ 1.450,-	
	1110 x 510 x 550
	770 x 430 x 460
	230 V / 0,34 kW
	150 L
	+2/+12°C
	R 600 A
	1x
	58

7450.0745		7450.0750	
€ 1.670,-		€ 2.700,-	
	706 x 706 x 1300	706 x 706 x 1800	
	638 x 632 x 578	638 x 632 x 1180	
	230 V / 0,28 kW	230 V / 0,48 kW	
	268 L	468 L	
	+2/+10°C	+2/+10°C	
	R 290	R 290	
	GN 2x 1/1 GN	4x 1/1 GN	
	96	160	

7451.0230		€ 50,-
	Grids	
>	7450.0600	

7451.0225		€ 10,-
	Set clips for grid	
>	7450.0600	



GEBAKSVITRINE

GEBÄCKVITRINE

DESSERT SHOW DISPLAY

DESSERT SHOW DISPLAY

VITRINE DE PÂTISSERIE



Cooking range

Drop-in

Ovens

Kitchen equipment

Refrigeration

Dishwashers

Neutral

Faucets

Ventilation

Pizzeria

Bakery



	7450.0840	7450.0845
	€ 2.650,-	€ 2.950,-
	650 x 650 x 1500	650 x 650 x 1950
	500 x 590 x 880	500 x 590 x 1330
	230 V	230 V
	280 L	400 L
	+2/+8°C	+2/+8°C
	R 290	R 290
	4x	5x
	180	209



Refrigeration

Refrigerators & Freezer Cabinets

Refrigerated & Freezer Counters

Saladettes

Coldrooms

Chest Freezers

Display Refrigeration

Ice Machines

DESSERT SHOW DISPLAY

GEBAKSVITRINE

GEBÄCKVITRINE

DESSERT SHOW DISPLAY

VITRINE DE PÂTISSERIE



LED



7489.5385

€ 4.320,-



GEKOELD | GEKÜHLT
REFRIGERATED | RÉFRIGÉRÉE

800 x 660 x 1870

230 V / 0,55 kW

400 L

+2/+10°C

R 290

5x

140

7489.5395

€ 4.935,-



TBV CHOCOLADE | FÜR SCHOKOLAD
FOR CHOCOLATE | POUR CHOCLAT

800 x 660 x 1870

230 V / 0,55 kW

400 L

+14/+16°C

R 290

5x

140



 NEUTRAAL VITRINE

 NEUTRAL VITRINE

 NEUTRAL DISPLAY

 VITRINE NEUTRE

NEUTRAL DISPLAY





7487.0230

7487.0240

€ 199,-

€ 250,-



	554 x 376 x 305	554 x 376 x 370
	25 L	45 L
	13	14





7487.0235

7487.0245

€ 170,-

€ 190,-



	554 x 361 x 305	554 x 361 x 370
	35 L	50 L
	12	13

Cooking range

Drop-in

Ovens

Kitchen equipment

Refrigeration

Dishwashers

Neutral

Faucets

Ventilation

Pizzeria

Bakery



Refrigeration

Refrigerators & Freezer Cabinets

Refrigerated & Freezer Counters

Saladettes

Coldrooms

Chest Freezers

Display Refrigeration

Ice Machines

COUNTER TOP

OPZETVITRINE

AUFSATZVITRINE

COUNTER TOP

PUIITS



LED



7487.0040

€ 950,-



GEKOELD | GEKÜHLT
REFRIGERATED | FROID

	767 x 612 x 328
	230 V / 0,11 kW
	67 L
	0/+12°C
	R 600 A
GN	8x 1/6
	✓
	✓
	27

7487.0085

€ 740,-



WARMHOUD | WÄRME
HOT | CHAUD

	767 x 612 x 328
	230 V / 0,34 kW
	67 L
	+30/+90°C
	R 600 A
GN	8x 1/6
	24



SUSHIVITRINE

SUSHI VITRINE

SUSHI DISPLAY

VITRINE À SUSHI

SUSHI DISPLAY



7487.0065

€ 960,-



7487.0070

€ 1.005,-



	1177 x 420 x 265	1352 x 420 x 265
	230 V / 0,18 kW	230 V / 0,18 kW
	0/+12°C	0/+12°C
	R 600 A	R 600 A
GN	4x 1/3	5x 1/3
	37	41



7487.0075

€ 1.040,-



	1529 x 420 x 265
	230 V / 0,18 kW
	0/+12°C
	R 600 A
GN	6x 1/3
	44

Cooking range

Drop-in

Ovens

Kitchen equipment

Refrigeration

Dishwashers

Neutral

Faucets

Ventilation

Pizzeria

Bakery



Refrigeration

Refrigerators & Freezer Cabinets

Refrigerated & Freezer Counters

Saladettes

Coldrooms

Chest Freezers

Display Refrigeration

Ice Machines

HOT DISPLAY



WARMHOUDVITRINE



WÄRMEVITRINE



HOT DISPLAY



VITRINE CHAUFFANTE



7487.0110

€ 740,-



ROTIEREND | ROTIEREND
ROTATING | ROTATIVE

	460 x 448 x 785
	230 V / 0,8 kW
	97 L
	+30/+90°C
	4x
	LED
	41

7487.0115

€ 670,-



	460 x 448 x 785
	230 V / 0,8 kW
	+30/+90°C
	3x
	24



WARMHOUDVITRINE

WÄRMEVITRINE

HOT DISPLAY

VITRINE CHAUFFANTE

HOT DISPLAY



	7487.0120	7487.0125	7487.0130
	€ 365,-	€ 410,-	€ 490,-
	554 x 361 x 311	554 x 361 x 376	700 x 361 x 376
	230 V / 0,8 kW	230 V / 0,8 kW	230 V / 1 kW
	35 L	50 L	80 L
	+30/+90°C	+30/+90°C	+30/+90°C
	1x	2x	2x
	14	16	19



	7487.0135	7487.0140
	€ 455,-	€ 515,-
	840 x 395 x 270	1190 x 395 x 270
	230 V / 0,8 kW	230 V / 1 kW
	+30/+90°C	+30/+90°C
GN	4x 1/3	6x 1/3
	34	41

Cooking range

Drop-in

Ovens

Kitchen equipment

Refrigeration

Dishwashers

Neutral

Faucets

Ventilation

Pizzeria

Bakery



Refrigeration

Refrigerators & Freezer Cabinets

Refrigerated & Freezer Counters

Saladettes

Coldrooms

Chest Freezers

Display Refrigeration

Ice Machines

COLD DISPLAY

KOELVITRINE

KÜHLVITRIN

COLD DISPLAY

VITRINE RÉFRIGÉRÉE



	7487.0055	7487.0060
	€ 1.095,-	€ 1.150,-
	697 x 578 x 678	875 x 578 x 678
	230 V / 0,23 kW	230 V / 0,23 kW
	130 L	160 L
	0/+12°C	0/+12°C
	R 600 A	R 600 A
	57	65

	7487.0045	7487.0050
	€ 1.250,-	€ 1.450,-
	797 x 590 x 685	1217 x 590 x 685
	230 V / 0,23 kW	230 V / 0,375 kW
	130 L	201 L
	0/+12°C	0/+12°C
	R 600 A	R 600 A
	68	87



 WARMHOUDVITRINE

 WÄRMEVITRINE

 HOT DISPLAY

HOT DISPLAY
 VITRINE CHAUFFANTE

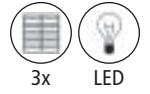

Cooking range

Drop-in

Ovens

Kitchen equipment

Refrigeration

Dishwashers

Neutral





Faucets





Ventilation

Pizzeria

Bakery



	7487.0090	7487.0095
	€ 790,-	€ 895,-
	678 x 578 x 698	857 x 578 x 698
	230 V / 1,1 kW	230 V / 1,5 kW
	130 L	160 L
	+30/+90°C	+30/+90°C
	49	54

	7487.0100	7487.0105
	€ 805,-	€ 965,-
	915 x 484 x 662,5	1214,5 x 484 x 662,5
	230 V / 1,1 kW	230 V / 1,8 kW
	136 L	186 L
	+30/+90°C	+30/+90°C
	44	87



Refrigeration

Refrigerators & Freezer Cabinets

Refrigerated & Freezer Counters

Saladettes

Coldrooms

Chest Freezers

Display Refrigeration

Ice Machines

COLD DISPLAY

KOELVITRINE

KÜHLVITRINE

COLD DISPLAY

VITRINE RÉFRIGÉRÉE



HOT DISPLAY

WARMHOUDVITRINE

WÄRMEVITRINE

HOT DISPLAY

VITRINE CHAUFFANTE

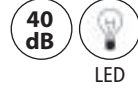

	7450.0605	7450.0610
	€ 730,-	€ 980,-
	682 x 450 x 675	678 x 568 x 670
	659 x 412 x 369	673 x 530 x 380
	230 V / 0,34 kW	230 V / 0,16 kW
	100 L	120 L
	+3/+8°C	+3/+8°C
	R 600 A	R 600 A
	1x	2x
	74	87

	7450.0615	7450.0620
	€ 710,-	€ 899,-
	682 x 450 x 675	678 x 568 x 670
	659 x 412 x 369	673 x 530 x 380
	230 V / 0,34 kW	230 V / 0,8 kW
	100 L	120 L
	+30/+90°C	+30/+90°C
	1x	2x
	62	75

COLD DISPLAY

 KOELVITRINE

 COLD DISPLAY



LED 2x

 KÜHLVITRINE

 VITRINE RÉFRIGÉRÉE

HOT DISPLAY

 WARMHOUDVITRINE

 HOT DISPLAY

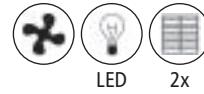













LED 2x

 WÄRMEVITRINE

 VITRINE CHAUFFANTE



	7450.0670	7450.0675
	€ 990,-	€ 1.380,-
	695 x 576 x 678	873 x 576 x 678
	662 x 479 x 396	840 x 479 x 396
	230 V / 0,16 kW	230 V / 0,16 kW
	125 L	159 L
	+3/+8°C	+3/+8°C
	R 600 A	R 600 A
	87	97

	7450.0680	7450.0685
	€ 900,-	€ 1.180,-
	690 x 580 x 671	868 x 580 x 671
	674 x 500 x 409	852 x 500 x 409
	230 V / 0,8 kW	230 V / 1,5 kW
	137 L	174 L
	+30/+90°C	+30/+90°C
	75	80



Refrigeration

ICE CUBE MAKER

Refrigerators & Freezer Cabinets

Refrigerated & Freezer Counters

Saladettes

Coldrooms

Chest Freezers

Display Refrigeration

Ice Machines



7476.0150

€ 699,-



	420 x 528 x 655
	230 V / 0,22 kW
	R 600 A
	26
	6
	36,5

7476.0150

	Air temp.	Water temp.	Prod. 24h/kg
	10°C	10°C	27
	21°C	15°C	24
	32°C	21°C	20

IJSBLOKJESMACHINE

- RVS behuizing
- Ventilatie aan de voorkant
- Luchtgekoeld
- Digitale bediening
- Verstelbare poten

EISWÜRFELMASCHINE

- Edelstahl Gehäuse
- Belüftung an der Vorseite
- Luftgekühlt
- Digitale Steuerung
- Verstellbare Füße

ICE CUBE MAKER

- Stainless Steel housing
- Front ventilation
- Air cooling
- Digital control
- Adjusting feet

MACHINE À GLAÇONS

- Boitier en acier inoxydable
- Ventilation à l'avant
- Refroidissement à l'air
- Control numérique
- Pieds ajustables



ICE CUBE MAKER



Cooking range

Drop-in

Ovens

Kitchen equipment

	7489.4000	7489.4005	7489.4010
	€ 1.300,-	€ 1.590,-	€ 1.910,-

Refrigeration

	355 x 435 x 590	500 x 580 x 690	500 x 580 x 800
	230 V / 0,4 kW	230 V / 0,5 W	230 V / 0,6 kW
	R 290	R 290	R 290
	22	32	47
	4	16	28
	26	38	45

Dishwashers

	7489.4000			7489.4005			7489.4010		
--	-----------	--	--	-----------	--	--	-----------	--	--

	Air temp.	Water temp.	Prod. 24h/kg	Air temp.	Water temp.	Prod. 24h/kg	Air temp.	Water temp.	Prod. 24h/kg
	10°C	10°C	37	10°C	10°C	37	10°C	10°C	37
	20°C	15°C	32	20°C	15°C	32	20°C	15°C	32
	30°C	20°C	21	30°C	20°C	21	30°C	20°C	21

Neutral

Faucets

IJSBLOKJESMACHINE

- Externe behuizing van AISI 304 rvs
- Omgevingstemp. +43°C
- Luchtgekoeld
- Sproeisysteem met AISI 316 metalen mondstukken/injectoren
- Eenvoudig schoon te maken luchtfilter
- Anti-bacterieel en geurvrije, grote ijsopslag
- Polyurethaan geïsoleerde body helpt om ijs langer op te slaan
- Elektronische bediening helpt water en energie te besparen

EISWÜRFELMASCHINE

- Außere Gehäuse von AISI 304 Edelstahl
- Umgebungstemp. +43°C
- Luftgekühlt
- Sprühsystem mit AISI 316 Edelstahl Mundstücke
- Luftfilter einfach sauber zu machen
- Große Vorratsbehälter, Antibakteriell und Geruchsfrei
- Gute Isolierung um Eis länger zu speichern
- Einfache Bedienung um Wasser und Energie zu ersparen

ICE CUBE MAKER

- External structure AISI 304 Scotch Brite
- Model in Tropical Class +43°C
- Air cooling
- Sprayer system with AISI 316 quality metallic nozzles/injectors
- Easy clean air filter
- Anti-bacterial and odour free, large ice storage bin
- Polyurethane isolated body helps ice to be stored for a longer time
- Electronic control helps to save water and energy

MACHINE À GLAÇONS / MACHINE À GLAÇON EN GRAIN

- Boîtier externe en Inox AISI 304
- Temp. ambiante +43°C
- Refroidissement à l'air
- Système de pulvérisation de qualité mécanique AISI 316 avec buses/injecteurs
- Filtre à air facile à nettoyer
- Grand bac de stockage de glace antibactérien et sans odeur
- Corps isolé en polyuréthane permettant de conserver la glace plus longtemps
- Le contrôle électronique permet d'économiser l'eau et l'énergie

Ventilation

Pizzeria

Bakery



Refrigeration

ICE CUBE MAKER

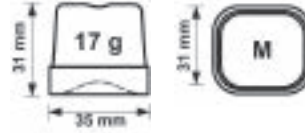

7453.0002*

€ 1.575,-

7453.0004

€ 1.760,-

7453.0006

€ 1.830,-

7453.0008

€ 2.150,-

	7453.0002*	7453.0004	7453.0006	7453.0008
	355 x 404 x 590	390 x 517 x 625	390 x 517 x 705	496 x 629 x 685
	230 V / 0,32 kW	230 V / 0,35 kW	230 V / 0,37 kW	230 V / 0,41 kW
	R 290	R 290	R 290	R 290
	20	25	29	34
	4	6	9	16
	31	41	48	56

* Plastic housing

7453.0002

	Air temp.	Water temp.	Prod. 24h/kg
	10°C	10°C	25
	21°C	15°C	22
	32°C	21°C	18

7453.0004

	Air temp.	Water temp.	Prod. 24h/kg
	10°C	10°C	32
	21°C	15°C	28
	32°C	21°C	22

7453.0006

	Air temp.	Water temp.	Prod. 24h/kg
	10°C	10°C	42
	21°C	15°C	37
	32°C	21°C	29

7453.0008

	Air temp.	Water temp.	Prod. 24h/kg
	10°C	10°C	49
	21°C	15°C	46
	32°C	21°C	40

IJSBLOKJESMACHINE

- Externe behuizing van AISI 304 rvs
- Geïsoleerde deur
- Interne bin isolatie HCFC vrij
- Omgevingstemp. +43°C
- Externe beschermende filter, verwijderbaar, eenvoudig schoon te maken

EISWÜRFELMASCHINE

- Außere Gehäuse von AISI 304 Edelstahl
- Isolierte Tür
- Innere Isolation HCFC Frei
- Umgebungstemp. +43°C
- Außere Schutzfilter, abnehmbar, leicht zu reinigen

ICE CUBE MAKER

- External structure AISI 304 Scotch Brite
- Insulated retractable door
- Internal bin insulation HCFC free
- Model in Tropical Class +43°C
- External protective filter, removable, easy to clean

MACHINE A GLAÇONS

- Boîtier externe en Inox AISI 304
- Porte isolée
- Isolation de bac interne sans HCFC
- Temp. ambiante +43°C
- Filtre protecteur externe, Amovible, facile à nettoyer

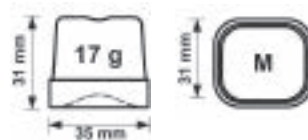

	7453.0010	7453.0012	7453.0014	7453.0016	7453.0018
	€ 2.235,-	€ 2.400,-	€ 3.190,-	€ 3.640,-	€ 4.965,-
	496 x 629 x 795	469 x 629 x 885	737 x 640 x 915	737 x 640 x 1015	840 x 740 x 1075
	230 V / 0,45 kW	230 V / 0,5 kW	230 V / 0,7 kW	230 V / 0,85 kW	230 V / 1,4 kW
	R 290	R 290	R 290	R 290	R 290
	43	53	68	100	155
	25	25	40	60	65
	64	70	89	102	138

	7453.0010			7453.0012			7453.0014			7453.0016			7453.0018		
	Air temp.	Water temp.	Prod. 24h/kg	Air temp.	Water temp.	Prod. 24h/kg	Air temp.	Water temp.	Prod. 24h/kg	Air temp.	Water temp.	Prod. 24h/kg	Air temp.	Water temp.	Prod. 24h/kg
	10°C	10°C	49	10°C	10°C	55	10°C	10°C	75	10°C	10°C	104	10°C	10°C	158
	21°C	15°C	46	21°C	15°C	53	21°C	15°C	68	21°C	15°C	100	21°C	15°C	155
	32°C	21°C	40	32°C	21°C	45	32°C	21°C	56	32°C	21°C	85	32°C	21°C	132

7453.0040	€ 165,-
	Ice machine cleaner



Refrigeration

Refrigerators & Freezer Cabinets

Refrigerated & Freezer Counters

Saladettes

Coldrooms

Chest Freezers

Display Refrigeration

Ice Machines

ICE CUBE MAKER



ICE STORAGE BIN

IJS OPSLAG BUNKER

EIS LAGERBUNKER

ICE STORAGE BIN

CONTENEUR STOCKAGE INTEGRÉ



	7453.0030	7453.0036
	€ 4.700,-	€ 7.875,-
	862 x 555 x 720	1250 x 580 x 848
	230 V / 1,4 W	230 V / 2,6 W
	R452A	R452A
	155	300
	120	180

	7453.0032	7453.0038
	€ 2.230,-	€ 3.235,-
>	7453.0030	7453.0036
	870 x 790 x 1000	1250 x 790 x 1000
	200	350
	110	150

	7453.0030		7453.0036			
	Air temp.	Water temp.	Prod. 24h/kg	Air temp.	Water temp.	Prod. 24h/kg
	10°C	10°C	160	10°C	10°C	320
	21°C	15°C	155	21°C	15°C	300
	32°C	21°C	132	32°C	21°C	260

7453.0040	€ 165,-
	Ice machine cleaner

IJSBLOKJESMACHINE

- Externe behuizing van AISI 304 rvs
- Luchtfilter is verwijderbaar en schoon te maken
- Zijpanelen zijn te verwijderen
- Makkelijk schoonmaak door afgeronde vlakken
- Omgevingstemp. +43°C

EISWÜRFELMASCHINE

- Außere Gehäuse von AISI 304 Edelstahl
- Luftfilter, abnehmbar, leicht zu reinigen
- Seitenteile abnehmbar
- Leicht zu reinigen durch abgerundete Oberflächen
- Umgebungstemp. +43°C

ICE CUBE MAKER

- External structure AISI 304 Scotch Brite
- Removable and cleanable air filter
- Removable side panels
- Easy cleaning thanks to rounded surfaces
- Model in Tropical Class +43°C

MACHINE À GLACON EN GRAIN

- Boitier externe en Inox AISI 304
- Filtre amovible et facile à nettoyer
- Panneaux Lateraux amovibles
- Facile a nettoyer grace aux surfaces arrondies
- Temp. ambiente +43°C



ICE FLAKE MACHINE



Cooking range

Drop-in

Ovens

Kitchen equipment

Refrigeration

Dishwashers

Neutral

Faucets

Ventilation

Pizzeria

Bakery

7453.0020

€ 4.170,-



7453.0022

€ 5.000,-



	496 x 660 x 685	741 x 678 x 925
	230 V / 0,55 kW	230 V / 0,65 kW
	R 290	R 290
	90	150
	19	38
	59	85

7453.0020

7453.0022

	Air temp.	Water temp.	Prod. 24h/kg	Air temp.	Water temp.	Prod. 24h/kg
	10°C	10°C	104	10°C	10°C	160
	21°C	15°C	95	21°C	15°C	155
	32°C	21°C	81	32°C	21°C	140

SCHILFERIJSMACHINE

- Externe behuizing van AISI 304 rvs
- Verdampfer van AISI 304 rvs, auger van AISI 303 rvs
- Stofvrij water basin
- Externe beschermende filter, verwijderbaar, eenvoudig schoon te maken
- Omgevingstemp. +43°C

SCHERBENEISERZEUEGR

- Außere Gehäuse von AISI 304 Edelstahl
- Verdampfer von AISI 304 Edelstahl
- Staubfrei Wasserbecken
- Außere Schutzfilter, abnehmbar, leicht zu reinigen
- Umgebungstemp. +43°C

ICE FLAKE MACHINE

- External structure AISI 304 Scotch Brite
- Evaporator AISI 304, auger AISI 303 made
- Dust proof water basin
- External protective filter, removable, easy to clean
- Model in Tropical Class +43°C

MACHINE À GLACON EN GRAIN

- Boîtier externe en Inox AISI 304
- Evaporateur en inox AISI 304
- Bassin d'eau sans poussière
- Filtre protecteur externe, Amovible, facile à nettoyer
- Temp. ambiente +43°C



Pizzeria
Pizzeria
Pizzeria
Pizzeria

10



PIZZA COUNTER

PIZZAWERKBANK

PIZZATISCH

PIZZA COUNTER

TABLE PRÉP POUR PIZZA

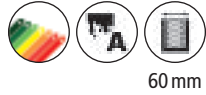

60 mm



REFRIGERATED COUNTER TOP

GEKOELDE OPZETVITRINE

AUFSATZVITRINE

REFRIGERATED COUNTER TOP

PUIITS RÉFRIGÉRÉE

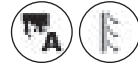

	7950.0040	7950.0044
	€ 1.775,-	€ 1.950,-
	1515 x 800 x 1000	2025 x 800 x 1000
	945 x 680 x 560	1455 x 680 x 560
	230 V / 0,34 kW	230 V / 0,34 kW
EN	2x 600x400	3x 600x400
	+2 / +8°C	+2 / +8°C
	R 600 A	R 600 A
dB	42	42
	280	295

	7450.0018	7450.0023
	€ 640,-	€ 760,-
	> 7950.0040	> 7950.0044
	1500 x 395 x 435	2000 x 395 x 435
	230 V / 0,34 kW	230 V / 0,34 kW
GN	6x 1/3 GN	9x 1/3 GN
	+2 / +8°C	+2 / +8°C
	R 600 A	R 600 A
	57	70

PIZZAWERKBANK

- Isolatie 60 mm
- Omgevingstemp. +43°C
- Vast ingebouwde compressor.
- Incl. 1 rooster per deur

PIZZATISCH

- Isolierschicht 60 mm
- Umgebungstemp. +43°C
- Fest installierte Kompressor
- Einschließlich 1 Gitter hinter jeden Tür

PIZZA COUNTER

- Insulation 60 mm
- Ambient temp. +43°C
- Permanently installed compressor
- Incl. 1 grid per door

TABLE PRÉP POUR PIZZA

- Isolation 60 mm.
- Temp. ambiente +43°C
- Compresseur fixé
- 1 Grille par porte inclus

7020.1210		€ 35,-
	Grids	
EN	600 x 400	

7451.0255		€ 30,-
	Set guides	
	1	

7020.0600		€ 20,-
	Pizza dough container	
EN	600 x 400 x 70	

7020.0605		€ 20,-
	Lid for pizza dough container	
	> 7020.0600	



PIZZA COUNTER

PIZZAWERKBANK

PIZZA COUNTER

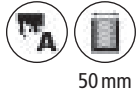

PIZZATISCH

TABLE PRÉP POUR PIZZA

REFRIGERATED COUNTER TOP

GEKOELDE OPZETVITRINE

AUFSATZVITRINE

REFRIGERATED COUNTER TOP

PUIITS RÉFRIGÉRÉE

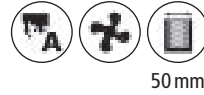

	7489.5220	7489.5225
	€ 3.335,-	€ 4.105,-
	1550 x 800 x 1080	2100 x 800 x 1080
	230 V / 0,2 kW	230 V / 0,21 kW
EN	6x 600x400	9x 600x400
	380 L	615 L
	-2 / +8°C	-2 / +8°C
	R 290	R 290
dB	40	40
	232	311

	7489.5240	7489.5245
	€ 1.540,-	€ 1.625,-
	> 7489.5220	> 7489.5225
	230 V / 0,12 kW	230 V / 0,12 kW
GN	6x 1/3 GN	10x 1/3 GN
	+4 / +10°C	+4 / +10°C
	R 290	R 290
	67	108

PIZZAWERKBANK

- Isolatie 50mm
- Omgevingstemp. +43°C
- Vast ingebouwde compressor
- Incl. 3 roosters per deur
- Cap. 8 geleiders per deur
- Ruimte tussen geleiders 60mm

PIZZATISCH

- Isolierschicht 50mm.
- Umgebungstemp. +43°C
- Fest installierte Kompressor
- Einschließlich 3 Gitter hinter jeden Tür
- Für maximal 8 Führungsschienen
- Abstand zwischen Führungsschienen 60mm

PIZZA COUNTER

- Insulation 50mm
- Ambient temp. +43°C
- Permanently installed compressor
- Incl. 3 grids per door
- Cap. 8 guides per door
- Space between guides 60mm

TABLE PRÉP POUR PIZZA

- Isolation 50mm
- Temp. ambiente +43°C
- Compresseur fixé
- 3 Grilles par porte inclus
- Cap. 8 Glissières par porte
- Espace entre les Glissières 60mm

7020.1210 € 35,-

Grids

EN 600 x 400

7489.0905 € 90,-

Castors set, 5x

7020.0600 € 20,-

Pizza dough container

EN 600 x 400 x 70

7020.0605 € 20,-

Lid for pizza dough container > 7020.0600

7489.0528 ON REQUEST

Drawer set

7489.0529 ON REQUEST

Drawer set

ON REQUEST

Door lock

60Hz ON REQUEST



PIZZA COUNTER WITH DRAWERS

PIZZAWERKBANK MET LADEN

PIZZATISCH MIT LADEN

PIZZA COUNTER WITH DRAWERS

TABLE PRÉP POUR PIZZA AVEC TIROIRS



60 mm



REFRIGERATED COUNTER TOP

GEKOELDE OPZETVITRINE

AUFSATZVITRINE

REFRIGERATED COUNTER TOP

PUIITS RÉFRIGÉRÉE



7950.0042

€ 2.180,-



	2025 x 800 x 1000
	945 x 680 x 560
	230 V / 0,34 kW
EN	2x 600x400
	+2 / +8°C
	R 600 A
dB	42
	295

7450.0023

€ 760,-



	> 7950.0042
	2000 x 395 x 435
	230 V / 0,34 kW
GN	9x 1/3 GN
	+2 / +8°C
	R 600 A
	70

PIZZAWERKBANK

- Isolatie 60 mm
- Omgevingstemp. +43°C
- Vast ingebouwde compressor
- Incl. 1 rooster per deur

PIZZATISCH

- Isolierschicht 60 mm
- Umgebungstemp. +43°C
- Fest installierte Kompressor
- Einschließlich 1 Gitter hinter jeden Tür

PIZZA COUNTER

- Insulation 60 mm
- Ambient temp. +43°C
- Permanently installed compressor
- Incl. 1 grid per door

TABLE PRÉP POUR PIZZA

- Isolation 60 mm.
- Temp. ambiente +43°C
- Compresseur fixé
- 1 Grille par porte inclus

7020.1210 € 35,-

	Grids
EN	600 x 400

7451.0255 € 30,-

	Set guides
	1

7020.0600 € 20,-

	Pizza dough container
EN	600 x 400 x 70

7020.0605 € 20,-

	Lid for pizza dough container
	> 7020.0600



PIZZA COUNTER WITH DRAWERS

PIZZAWERKBANK MET LADEN

PIZZATISCH MIT LADEN

PIZZA COUNTER WITH DRAWERS

TABLE PRÉP POUR PIZZA AVEC TIROIRS

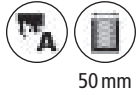

50 mm



REFRIGERATED COUNTER TOP

GEKOELDE OPZETVITRINE

AUFSATZVITRINE

REFRIGERATED COUNTER TOP

PUIITS RÉFRIGÉRÉE

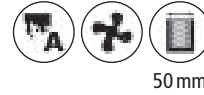

50 mm



	7489.5230	7489.5235
	€ 3.870,-	€ 4.505,-
	1550 x 800 x 1080	2100 x 800 x 1080
	230 V / 0,2 kW	230 V / 0,21 kW
EN	3x 600x400	6x 600x400
	380 L	615 L
	-2 / +8°C	-2 / +8°C
	R 290	R 290
dB	40	40
	236	311

	7489.5240	7489.5245
	€ 1.540,-	€ 1.625,-
	> 7489.5230	> 7489.5235
	1550 x 390 x 460	2100 x 390 x 460
	230 V / 0,12 kW	230 V / 0,12 kW
GN	6x 1/3 GN	10x 1/3 GN
	+4 / +10°C	+4 / +10°C
	R 290	R 290
	67	108

PIZZAWERKBANK

- Isolatie 50 mm
- Omgevingstemp. +43°C
- Vast ingebouwde compressor
- Incl. 3 roosters per deur
- Cap. 8 geleiders per deur
- Ruimte tussen geleiders 60 mm

PIZZATISCH

- Isolierschicht 50 mm.
- Umgebungstemp. +43°C
- Fest installierte Kompressor
- Einschließlich 3 Gitter hinter jeden Tür
- Für maximal 8 Führungsschienen
- Abstand zwischen Führungsschienen 60 mm

PIZZA COUNTER

- Insulation 50 mm
- Ambient temp. +43°C
- Permanently installed compressor
- Incl. 3 grids per door
- Cap. 8 guides per door
- Space between guides 60 mm

TABLE PRÉP POUR PIZZA

- Isolation 50 mm
- Temp. ambiente +43°C
- Compresseur fixé
- 3 Grilles par porte inclus
- Cap. 8 Glissières par porte
- Espace entre les Glissières 60 mm

7020.1210 **€ 35,-**

Grids

EN 600 x 400

7020.0600 **€ 20,-**

Pizza dough container

EN 600 x 400 x 70

7020.0605 **€ 20,-**

Lid for pizza dough container > 7020.0600

7489.0528 **ON REQUEST**

Drawer set

7489.0529 **ON REQUEST**

Drawer set

ON REQUEST

Door lock

60Hz **ON REQUEST**

Cooking range

Drop-in

Ovens

Kitchen equipment

Refrigeration

Dishwashers

Neutral

Faucets

Ventilation

Pizzeria

Bakery



PIZZA COUNTER

PIZZAWERKBANK

PIZZATISCH

PIZZA COUNTER

TABLE PRÉP POUR PIZZA



REFRIGERATED COUNTER TOP

GEKOELDE OPZETVITRINE

AUFSATZVITRINE

REFRIGERATED COUNTER TOP

PUIITS RÉFRIGÉRÉE



7950.0060

€ 1.520,-



	1400 x 700 x 1020
	1291 x 595 x 456
	230 V / 0,34 kW
GN	3x 1/1
	+2 / +8°C
	R 600 A
dB	48
	130

7450.0007

€ 555,-



	> 7950.0060
	1400 x 335 x 435
	230 V / 0,34 kW
	+2 / +8°C
	R 600 A
	51

7450.0500 € 35,-

	Set guides
>	7450.0220-0580

7950.5049 € 45,-

	Set guides
>	7950.0065-0070

7950.5048 € 45,-

	Set guides
>	7950.0060

7020.1200 € 30,-

	Grids SS
GN	1/1GN

7450.0505 € 27,-

	Grids PE COATED
GN	1/1GN

7003.0510 € 235,-

	Support for pizza counter
	905 x 638 x 103

7003.0515 € 245,-

	Support for pizza counter
	1370 x 638 x 103



PIZZA COUNTER

PIZZAWERKBANK

PIZZATISCH

PIZZA COUNTER

TABLE PRÉP POUR PIZZA



7950.0070

€ 930,-



	903 x 700 x 1090		380 L
	830 x 595 x 456		-2 / +8°C
	230 V / 0,34 kW		R 600 A
GN	2x 1/1 GN 5x 1/6 GN	dB	48
	95		

7950.0065

€ 1.300,-



	1368 x 700 x 1090		+2 / +8°C
	1295 x 595 x 456		R 600 A
	230 V / 0,34 kW	dB	48
GN	3x 1/1 GN 8x 1/6 GN		155

Cooking range

Drop-in

Ovens

Kitchen equipment

Refrigeration

Dishwashers

PIZZA COUNTER

PIZZAWERKBANK

PIZZATISCH

PIZZA COUNTER

TABLE PRÉP POUR PIZZA



7450.0580

€ 2.300,-



	1420 x 700 x 1060	GN	2x 1/1
	830 x 595 x 456		+2 / +8°C
	230 V / 0,34 kW		R 600 A
	268	dB	48

7450.0220

€ 1.620,-



	1368 x 700 x 1180	GN	8x 1/6 PAN
	1395 x 595 x 456		+2 / +8°C
	230 V / 0,34 kW		R 600 A
	155	dB	50

Neutral

Faucets

Ventilation

Pizzeria

Bakery



PIZZA COUNTER

PIZZAWERKBANK

PIZZATISCH

PIZZA COUNTER

TABLE PRÉP POUR PIZZA

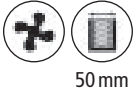

50 mm

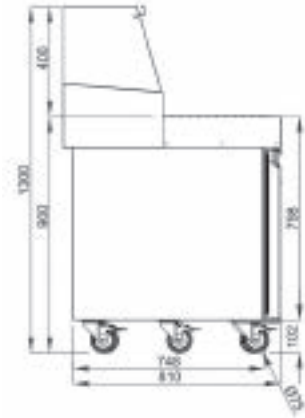

7489.5300

€ 7.355,-



	1790 x 850 x 1360		460 L
	230 V / 0,3 kW		-2 / +8°C
	6x 460 x 660		R 290
	237		



7489.5305

€ 8.885,-



	2370 x 850 x 1360		720 L
	230 V / 0,3 kW		-2 / +8°C
	9x 460 x 660		R 290
	338		



GN CONTAINER

- GN PAN
- GN BEHÄLTER
- GN CONTAINER
- GN RÉCIPIENT



		GN				
7476.0050	530x325x20	1/1	✓	1	€ 15,-	
7476.0055	530x325x40	1/1	✓	1	€ 18,-	
7476.0060	530x325x65	1/1	✓	1	€ 20,-	
7476.0160	530x325x100	1/1	✓	1	€ 23,-	
7476.0065	530x325x150	1/1	✓	1	€ 36,-	
7476.0165	325x265x65	1/2	✓	1	€ 11,-	
7476.0170	325x265x100	1/2	✓	1	€ 15,-	
7476.0070	325x265x150	1/2	✓	1	€ 24,-	
7476.0175	325x176x65	1/3	✓	1	€ 10,-	
7476.0180	325x176x100	1/3	✓	1	€ 13,-	
7476.0075	325x176x150	1/3	✓	1	€ 20,-	
7476.0185	265x162x65	1/4	✓	1	€ 9,-	
7476.0190	265x162x100	1/4	✓	1	€ 11,-	
7476.0080	265x162x150	1/4	✓	1	€ 16,-	
7476.0195	176x162x65	1/6	✓	1	€ 8,-	
7476.0200	176x162x100	1/6	✓	1	€ 10,-	
7476.0085	176x162x150	1/6	✓	1	€ 13,-	
7476.0090	176x108x100	1/9	✓	1	€ 10,-	

GN LID

- GN DEKSEL
- GN DECKEL
- GN LID
- GN COUVRIR



		GN				
7476.0100	530 x 325	1/1	✓	1	€ 16,-	
7476.0105	325 x 265	1/2	✓	1	€ 10,-	
7476.0110	325 x 175	1/3	✓	1	€ 8,-	
7476.0115	264 x 162	1/4	✓	1	€ 7,-	
7476.0120	176 x 162	1/6	✓	1	€ 7,-	
7476.0125	176 x 108	1/9	✓	1	€ 4,-	

GN CONTAINER PERFORATED

- GN PAN GEPERFOREERD G
- GN BEHÄLTER PERFORIERT
- GN CONTAINER PERFORATE
- GN RÉCIPIENT PERFORÉ



		GN				
7476.0205	530x325x65	1/1	✓	1	€ 22,-	
7476.0210	530x325x150	1/1	✓	1	€ 40,-	
7476.0215	325x265x65	1/2	✓	1	€ 18,-	
7476.0220	325x265x150	1/2	✓	1	€ 26,-	

GN BAR

- GN STEG
- GN STEGE
- GN BAR
- GN BARRE



	L	GN				
7216.1150	20	1/1	✓	1	€ 20,-	
7216.1151	20	1/2	✓	1	€ 15,-	
7216.1152	20	1/3	✓	1	€ 15,-	
7216.1153	20	1/4	✓	1	€ 15,-	
7216.1154	20	1/6	✓	1	€ 10,-	

Cooking range

Drop-in

Ovens

Kitchen equipment

Refrigeration

Dishwashers

Neutral

Faucets

Ventilation

Pizzeria

Bakery



REFRIGERATED COUNTER TOP



GEKOELDE OPZETVITRINE



AUFSATZVITRINE



REFRIGERATED COUNTER TOP



PUITS RÉFRIGÉRÉE



7450.0005	7450.0007	7450.0009	7450.0011	7450.0013
€ 535,-	€ 555,-	€ 695,-	€ 660,-	€ 730,-

335 depth

	1200 x 335 x 435	1400 x 335 x 435	1600 x 335 x 435	1800 x 335 x 435	2000 x 335 x 435
	230 V / 0,34 kW	230 V / 0,34 kW	230 V / 0,34 kW	230 V / 0,34 kW	230 V / 0,34 kW
GN	5x 1/4	6x 1/4	7x 1/4	8x 1/4	10x 1/4
	+2 / +8°C	+2 / +8°C	+2 / +8°C	+2 / +8°C	+2 / +8°C
	R 600 A	R 600 A	R 600 A	R 600 A	R 600 A
dB	40	40	40	40	40
	47	51	56	58	66

7450.0015	7450.0017	7450.0019	7450.0021	7450.0023
€ 570,-	€ 625,-	€ 750,-	€ 730,-	€ 760,-

395 depth

	1200 x 395 x 435	1400 x 395 x 435	1600 x 395 x 435	1800 x 395 x 435	2000 x 395 x 435
	230 V / 0,34 kW	230 V / 0,34 kW	230 V / 0,34 kW	230 V / 0,34 kW	230 V / 0,34 kW
GN	4x 1/3	6x 1/3	7x 1/3	8x 1/3	9x 1/3
	+2 / +8°C	+2 / +8°C	+2 / +8°C	+2 / +8°C	+2 / +8°C
	R 600 A	R 600 A	R 600 A	R 600 A	R 600 A
dB	40	40	40	40	40
	48	53	60	66	70



OPZETVITRINE
RVS DEKSEL

AUFSATZVITRINE
EDELSTAHL DECKEL

REFRIGERATED
COUNTER TOP SS TOP

PUIITS RÉFRIGÉRÉE
COUVERCLE EN ACIER
INOX



Cooking range

Drop-in

Ovens

Kitchen equipment

Refrigeration

Dishwashers

Neutral

Faucets

Ventilation

Pizzeria

Bakery

7450.0025

7450.0027

7450.0029

€ 535,-

€ 620,-

€ 755,-

335 depth

	1200 x 335 x 225	1500 x 335 x 225	2000 x 335 x 225
	230 V / 0,34 kW	230 V / 0,34 kW	230 V / 0,34 kW
GN	5x 1/4	6x 1/4	10x 1/4
	+2 / +7°C	+2 / +7°C	+2 / +7°C
dB	40	40	40
	35	38	43

7450.0031

7450.0033

7450.0035

€ 585,-

€ 630,-

€ 805,-

395 depth

	1200 x 395 x 225	1500 x 395 x 225	2000 x 395 x 225
	230 V / 0,34 kW	230 V / 0,34 kW	230 V / 0,34 kW
GN	3x 1/3	6x 1/3	9x 1/3
	+2 / +7°C	+2 / +7°C	+2 / +7°C
dB	40	40	40
	36	39	45



Bakkerij
Bäckerei
Bakery
Boulangerie



REFRIGERATED BAKERY COUNTER

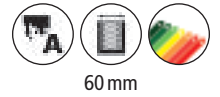

Cooking range

Drop-in

Ovens

Kitchen equipment

Refrigeration

Dishwashers

Neutral

Faucets

Ventilation

Pizzeria

Bakery

7950.0420

€ 3.495,-



	1510 x 800 x 1365		428 L
	945 x 680 x 560		+2 / +8°C
	230 V / 0,19 kW		R 290
GN	4x 1/1 GN pan	dB	42
	130		2x 600 x 400

BAKKERSKOELWERKBANK

- Isolatie 60mm
- Omgevingtemp. +32°C
- Vast ingebouwde compressor
- Incl. 1 rooster en geleidersets per deur
- Cap. 10 geleiders per deur
- Ruimte tussen geleiders 55mm
- Rechte glasopzet
- Incl. schuifruitjes aan de bedieningskant

BÄCKEREI KÜHLTISCH

- Isolierschicht 60mm
- Umgebungtemp. +32°C
- Fest installierte Kompressor
- Einschließlich 1 Gitter mit Führungsschiene hinter jeden Tür
- Für maximal 10 Führungsschienen
- Abstand zwischen Führungsschienen 55mm
- Gerade Glasaufsatz
- Inkl. Schiebe Glastüren an der Bedienung Seite

REFRIGERATED BAKERY COUNTER

- Insulation 60mm
- Ambient temp. +32°C
- Permanently installed compressor
- Incl. 1 grid and set guides per door
- Cap. 10 guides per door
- Space between guides 55mm
- Straight glass cover
- Incl. sliding glass doors on the operating side

TABLE RÉFRIGÉRÉE PÂTISSERIE

- Isolation 60mm
- Temp. ambiente +32°C
- Compresseur fixé
- Straight glass cover
- Cap. 10 Glissières par porte
- Espace entre les Glissières 55mm
- Structure en verre droite
- Incl. portes coulissantes du côté commande

7020.1210 € 35,-

	Grids
EN	600 x 400

7451.0010 € 83,-

	Castors set, 4x
--	-----------------

7451.0255 € 30,-

	Set guides
	1



REFRIGERATED BAKERY COUNTER



60 mm

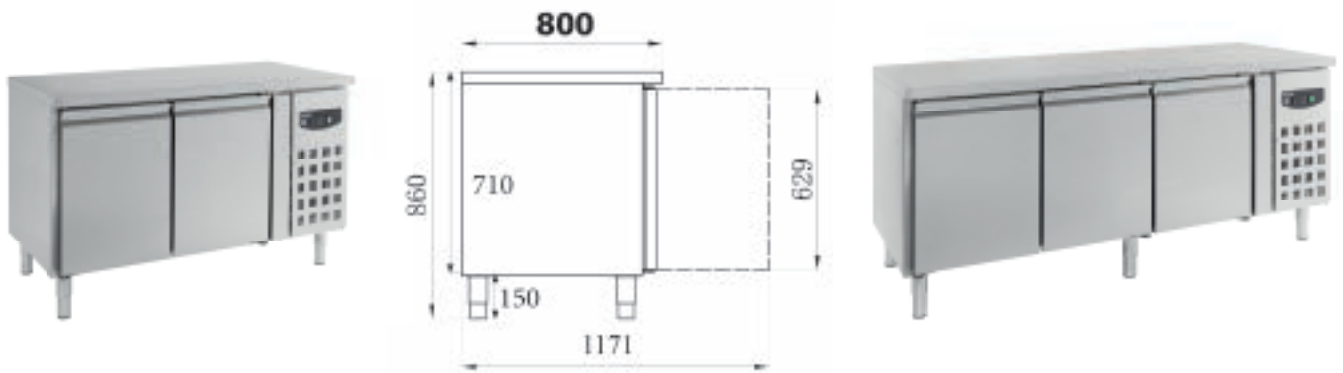

7450.1215			
€ 1.570,-			
	1510 x 800 x 860		428 L
	945 x 680 x 560		+2 / +8°C
	300 V / 0,34 kW		R 600 A
	155	dB	50

7450.1220			
€ 1.865,-			
	2020 x 800 x 850		635 L
	1455 x 680 x 560		+2 / +8°C
	300 V / 0,34 kW		R 600 A
	170	dB	50

BAKKERSKOEL-WERKBANK

- Isolatie 60 mm
- Omgevingstemp. +38°C
- Vast ingebouwde compressor
- Incl. 1 roosters per deur

BÄCKEREI KÜHLTISCH

- Isolierschicht 60 mm
- Umgebungstemp. +38°C
- Fest installierte Kompressor
- Einschließlich 1 Gitter hinter jeden Tür

REFRIGERATED BAKERY COUNTER

- Insulation 60 mm
- Ambient temp. +38°C
- Permanently installed compressor
- Incl. 1 grids per door

TABLE RÉFRIGÉRÉE PÂTISSERIE

- Isolation 60 mm
- Temp. ambiente +38°C
- Compresseur fixé
- 1 Grilles par porte inclus

7020.1210			€ 35,-
	Grids		
EN	600 x 400		

7451.0255			€ 30,-
	Set guides		
	1		



REFRIGERATED BAKERY COUNTER

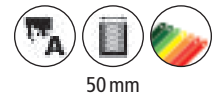

50 mm



Cooking range

Drop-in

Ovens

Kitchen equipment

Refrigeration

Dishwashers

Neutral

Faucets

Ventilation

Pizzeria

Bakery

7489.5250

€ 3.235,-

	1550 x 800 x 850		380 L
	230 V / 0,17 kW		-2 / +8°C
EN	6x 600 x 400		R 290
	159	dB	40

7489.5255

€ 3.735,-

	2100 x 800 x 850		615 L
	230 V / 0,2 kW		-2 / +8°C
EN	9x 600 x 400		R 290
	260	dB	40

**BAKKERSKOEL-
WERKBANK**

- Isolatie 50 mm
- Omgevingtemp. +43°C
- Vast ingebouwde compressor
- Incl. 3 roosters per deur
- Cap. 8 geleiders per deur
- Ruimte tussen geleiders 60 mm

BÄCKEREI KÜHLTISCH

- Isolierschicht 50 mm
- Umgebungtemp. +43°C
- Fest installierte Kompressor
- Einschließlich 3 Gitter hinter jeden Tür
- Für maximal 8 Führungsschienen
- Abstand zwischen Führungsschienen 60 mm

**REFRIGERATED
BAKERY COUNTER**

- Insulation 50 mm
- Ambient temp. +43°C
- Permanently installed compressor
- Incl. 3 grids per door
- Cap. 8 guides per door
- Space between guides 60 mm

**TABLE RÉFRIGÉRÉE
PÂTISSERIE**

- Isolation 50 mm
- Temp. ambiente +43°C
- Compresseur fixé
- 3 Grilles par porte inclus
- Cap. 8 Glissières par porte
- Espace entre les Glissières 60 mm

7202.1210 € 35,-

	Grids
EN	600 x 400

7489.0905 € 90,-

	Castors set, 5x
--	-----------------

7489.0528 ON REQUEST

	Drawer set
--	------------

7489.0529 ON REQUEST

	Drawer set
--	------------

7202.0600 € 20,-

	Pizza dough container
EN	600 x 400 x 70

ON REQUEST

	Door lock
--	-----------

60Hz ON REQUEST



REFRIGERATED/FREEZED BAKERY CABINET

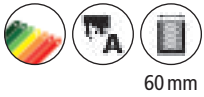

60 mm

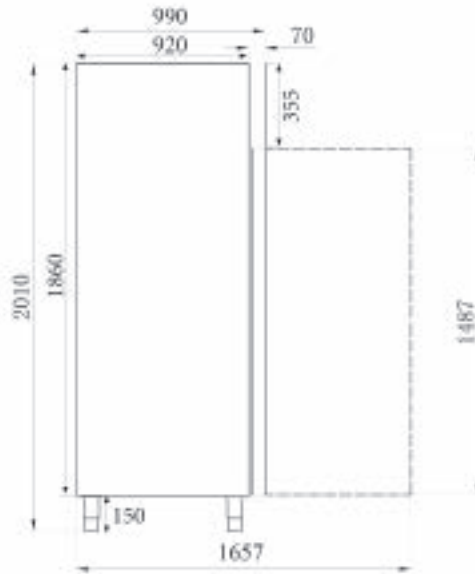

7450.1205

€ 1.605,-



REFRIGERATED

	740 x 990 x 2010		737 L
	624 x 860 x 1400		+2 / +8°C
	300 V / 0,43 kW		R 290
	170	dB	48

7450.1210

€ 1.965,-



FREEZED

	740 x 990 x 2010		737 L
	624 x 860 x 1400		-18 / -22°C
	300 V / 0,63 kW		R 290
	161	dB	48

BAKKERSKOEL- / VRIESKAST

- Isolatie 60 mm.
- Omgevingstemp. +32°C
- Vast ingebouwde compressor
- Cap. 10 geleiders

BÄCKEREI KÜHL- / TIEFKÜHLSCHRANK

- Isolierschicht 60 mm.
- Umgebungstemp. +32°C
- Fest installierte Kompressor
- Für maximal 10 Führungsschienen

REFRIGERATED/FREEZED BAKERY CABINET

- Insulation 60 mm.
- Ambient temp. +32°C
- Permanently installed compressor
- Cap. 10 guides per door

RÉFRIGÉRATEUR / CONGÉLATEUR PÂTISSERIE

- Isolation 60 mm.
- Temp. ambiente +32°C
- Compresseur fixé
- Cap. 10 Glissières par porte

7450.0508 € 56,-

	Grids
	600 x 800

7451.0240 € 34,-

	Set guides
	1



REFRIGERATED/FREEZED BAKERY CABINET

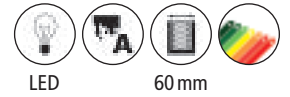
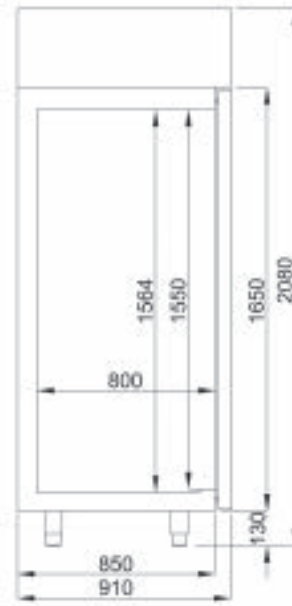

Cooking range

Drop-in

Ovens

Kitchen equipment

Refrigeration

Dishwashers

Neutral

Faucets

Ventilation

Pizzeria

Bakery

7489.5190

€ 3.240,-



REFRIGERATED

	800 x 910 x 2080		-2 / +8°C
	230 V / 0,30 kW		R 290
	850 L	dB	45
			169

7489.5195

€ 3.700,-



FREEZED

	800 x 910 x 2080		-10 / -22°C
	230 V / 0,6 kW		R 290
	850 L	dB	60
			176

BAKKERSKOEL- / VRIESKAST

Monoblock

- Isolatie 60mm.
- Omgevingstemp. +32°C
- Cap. 14 geleiders
- Ruimte tussen geleiders 45mm.

BÄCKEREI KÜHL- / TIEFKÜHLSCHRANK

Monoblock

- Isolierschicht 60mm.
- Umgebungstemp. +32°C
- Für maximal 14 Führungsschienen
- Abstand zwischen Führungsschienen 45mm

REFRIGERATED/FREEZED BAKERY CABINET

Monoblock

- Insulation 60mm.
- Ambient temp. +32°C
- Cap. 14 guides per door
- Space between guides 45mm.

RÉFRIGÉRATEUR / CONGÉLATEUR PÂTISSERIE

Monoblock

- Isolation 60mm.
- Temp. ambiente +32°C
- Cap. 14 Glissières par porte
- Espace entre les Glissières 45mm

7489.0905 € 90,-



Castors set, 5x

7020.0600 € 20,-



Pizza dough container

EN 600 x 400 x 70

60Hz ON REQUEST



Bakery

COLD DISPLAY

KOELVITRINE

KÜHLVITRINE

COLD DISPLAY

VITRINE RÉFRIGÉRÉE



	7487.0165	7487.0170	7487.0175	7487.0180
	€ 560,-	€ 560,-	€ 575,-	€ 625,-
	428 x 386 x 885	428 x 386 x 885	428 x 386 x 960	428 x 386 x 1100
	230 V / 0,18 kW	230 V / 0,18 kW	230 V / 0,18 kW	230 V / 0,18 kW
	68 L	68 L	78 L	98 L
	0/+12°C	0/+12°C	0/+12°C	0/+12°C
	R 600 A	R 600 A	R 600 A	R 600 A
	3x	3x	3x	3x
	35	35	36	41

GRIDS		€ 10,-	
		7487.0181	7487.0183
	>	7487.0165	7487.0170-0175-0180

SET CLIPS FOR GRID		€ 10,-	
		7487.0185	7487.0186
	>	7487.0165	7487.0170-0175-0180

KOELVITRINE

KÜHLVITRINE

COLD DISPLAY

VITRINE RÉFRIGÉRÉE



Cooking range

Drop-in

Ovens

Kitchen equipment

Refrigeration

Dishwashers

Neutral

Faucets

Ventilation

Pizzeria

Bakery



7487.0080

7487.0160

€ 975,-

€ 1.115,-

ROTEREND | ROTIERENDE | ROTATING | ROTATIVE

	480 x 480 x 1030	450 x 450 x 983
	230 V / 0,18 kW	230 V / 0,19 kW
	100 L	72 L
	+2/+8°C	0/+10°C
	R 600 A	R 600 A
	3x	4x
	55	55



Bakery

COLD DISPLAY

KOELVITRINE

KÜHLVITRINE

COLD DISPLAY

VITRINE RÉFRIGÉRÉE

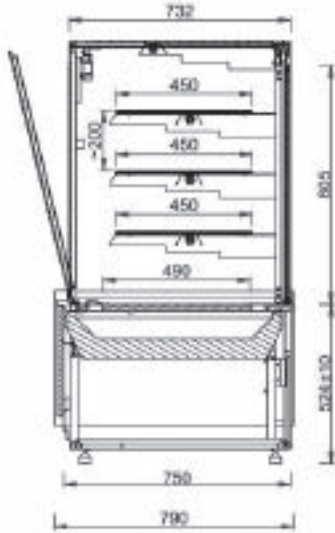

7486.0090

€ 4.720,-



7486.0095

€ 5.370,-



NERO

	937 x 790 x 1400	1437 x 790 x 1400
	230 V / 0,42 kW	230 V / 0,62 kW
	+4/+12°C	+4/+12°C
	R 290	R 290

KOELVITRINE

KÜHLVITRINE

COLD DISPLAY

VITRINE RÉFRIGÉRÉE

COLD DISPLAY

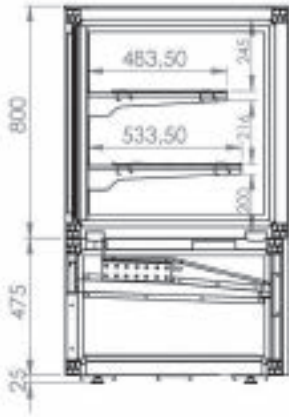

Cooking range

Drop-in

Ovens

Kitchen equipment

Refrigeration

Dishwashers

Neutral

Faucets

Ventilation

Pizzeria

Bakery

	7489.5450	7489.5455	7489.5460	7489.5465	7489.5470
	€ 3.400,-	€ 3.850,-	€ 4.215,-	€ 5.370,-	€ 6.635,-
	800 x 780 x 1300	1000 x 780 x 1300	1200 x 780 x 1300	1600 x 780 x 1300	2000 x 780 x 1300
	230 V / 0,35 kw	230 V / 0,4 kw	230 V / 0,45 kw	230 V / 0,5 kw	230 V / 0,55 kw
	+2/+10°C	+2/+10°C	+2/+10°C	+2/+10°C	+2/+10°C
	300 L	375 L	450 L	600 L	750 L
	R 290	R 290	R 290	R 290	R 290
	100	105	110	115	120



Bakery

COLD DISPLAY

 KOELVITRINE

 KÜHLVITRINE







 COLD DISPLAY

 VITRINE RÉFRIGÉRÉE



LED 2x



	7487.0015	7487.0020	7487.0025
	€ 2.370,-	€ 2.755,-	€ 110,-
	915 x 675 x 1210	1215 x 675 x 1210	1515 x 675 x 1210
	230 V / 0,48 kW	230 V / 0,49 kW	230 V / 0,5 kW
	270 L	370 L	470 L
	+2/+8°C	+2/+8°C	+2/+8°C
	R 290	R 290	R 290
	172	198	224

KOELVITRINE

KÜHLVITRINE

COLD DISPLAY

VITRINE RÉFRIGÉRÉE

COLD DISPLAY



	7450.0820	7450.0825
	€ 2.815,-	€ 3.250,-
	900 x 680 x 1200	1200 x 680 x 1200
	230 V / 0,33 kW	230 V / 0,34 kW
	190 L	257 L
	+2/+8°C	+2/+8°C
	R 290	R 290
	150	191



	7450.0830	7450.0835
	€ 3.680,-	€ 4.350,-
	1500 x 680 x 1200	2000 x 680 x 1200
	230 V / 0,35 kW	230 V / 0,51 kW
	324 L	436 L
	+2/+8°C	+2/+8°C
	R 290	R 290
	245	360

Cooking range

Drop-in

Ovens

Kitchen equipment

Refrigeration

Dishwashers

Neutral

Faucets

Ventilation

Pizzeria

Bakery



Bakery

COLD DISPLAY

 KOELVITRINE

 KÜHLVITRINE

 COLD DISPLAY









 VITRINE RÉFRIGÉRÉE



7487.0220

€ 2.460,-











	650 x 805 x 1445
	230 V / 0,46 kW
	300 L
	+2/+8°C
	R 600 A
	LED
	3x
	158

7487.0225

€ 855,-



	685 x 874 x 419
	230 V / 0,11 kW
	128 L
	+2/+12°C
	R 600 A
	X
	1x
	45

COLD DISPLAY

KOELVITRINE

KÜHLVITRINE

COLD DISPLAY

VITRINE RÉFRIGÉRÉE



7450.0800

€ 2.815,-



7450.0805

€ 3.160,-



	900 x 680 x 1200	1200 x 680 x 1200
	230 V / 0,33 kW	230 V / 0,34 kW
	175 L	236 L
	+2/+8°C	+2/+8°C
	R 290	R 290
	150	191



7450.0810

€ 3.500,-



7450.0815

€ 4.250,-



	1500 x 680 x 1200	2000 x 680 x 1200
	230 V / 0,35 kW	230 V / 0,51 kW
	298 L	400 L
	+2/+8°C	+2/+8°C
	R 290	R 290
	245	360



Bakery

DESSERT SHOW DISPLAY

GÉBAKSVITRINE

GEBÄCKVITRINE

DESSERT SHOW DISPLAY

VITRINE DE PÂTISSERIE



7450.0600	
€ 1.450,-	
	1110 x 510 x 550
	770 x 430 x 460
	230 V / 0,34 kW
	150 L
	+2/+12°C
	R 600 A
	1x
	58

7450.0745		7450.0750	
€ 1.670,-		€ 2.700,-	
	706 x 706 x 1300		706 x 706 x 1800
	638 x 632 x 578		638 x 632 x 1180
	230 V / 0,28 kW		230 V / 0,48 kW
	268 L		468 L
	+2/+10°C		+2/+10°C
	R 290		R 290
	2x 1/1 GN		4x 1/1 GN
	96		160

7451.0230		€ 50,-	
	Grids	>	7450.0600

7487.0182		€ 10,-	
	Set clips for grid	>	7450.0600

GEBAKSVITRINE

GEBÄCKVITRINE

DESSERT SHOW DISPLAY

DESSERT SHOW DISPLAY

VITRINE DE PÂTISSERIE



Cooking range

Drop-in

Ovens

Kitchen equipment

Refrigeration

Dishwashers

Neutral

Faucets

Ventilation

Pizzeria



	7450.0840	7450.0845
	€ 2.650,-	€ 2.950,-
	650 x 650 x 1500	650 x 650 x 1950
	500 x 590 x 880	500 x 590 x 1330
	230 V	230 V
	280 L	400 L
	+2/+8°C	+2/+8°C
	R 290	R 290
	4x	5x
	180	209

Bakery



Bakery

DESSERT SHOW DISPLAY

GEBAKSVITRINE

GEBÄCKVITRINE

DESSERT SHOW DISPLAY

VITRINE DE PÂTISSERIE



LED



7489.5385

€ 4.320,-



7489.5395

€ 4.935,-



GEKOELD | GEKÜHLT
REFRIGERATED | RÉFRIGÉRÉE

TBV CHOCOLADE | FÜR SCHOKOLAD
FOR CHOCOLATE | POUR CHOCLAT

	800 x 660 x 1870	800 x 660 x 1870
	230 V / 0,55 kW	230 V / 0,55 kW
	400 L	400 L
	+2/+10°C	+14/+16°C
	R 290	R 290
	5x	5x
	140	140

Art. 1 Toepasselijkheid van deze voorwaarden

- 1.1 In deze algemene voorwaarden wordt onder verkoper verstaan de gebruiker van de algemene voorwaarden, Combisteel BV te Houten en de aan deze vennootschap gelieerde vennootschappen.
- 1.2 Deze algemene verkoopvoorwaarden zijn van toepassing op de totstandkoming, de inhoud en de uitvoering van alle na 1 januari 2002 gesloten overeenkomsten tussen verkoper en de wederpartij en voorts op alle door verkoper na 1 januari 2002 uitgebrachte offertes. Op voordien gesloten overeenkomsten en uitgebrachte offertes zijn de voor 1 januari 2002 geldende algemene verkoopvoorwaarden van toepassing.

Art. 2 Offertes

- 2.1 Alle offertes van verkoper zijn vrijblijvend, tenzij deze een termijn voor aanvaarding bevatten.
- 2.2 Indien een offerte van verkoper een vrijblijvend aanbod bevat en dit door de wederpartij wordt aanvaard, heeft verkoper het recht het aanbod onverwijld na ontvangst van de aanvaarding te herroepen.
- 2.3 Alle bij een aanbod verstrekte informatie en/of specificaties inzake maten, gewichten, inhoud, capaciteit e.d. gelden altijd bij benadering. Deze informatie en/of specificaties zijn voor verkoper slechts bindend indien dit uitdrukkelijk schriftelijk is bevestigd. Alle bij een aanbod verstrekte gegevens en/of informatie blijft eigendom van verkoper en dient op eerste verzoek geretourneerd te worden.
- 2.4 De wederpartij draagt het risico van de niet-juiste uitvoering van de door hem bij zijn opdracht of latere wijzigingen van zijn opdracht opgegeven aanwijzingen en specificaties indien deze niet schriftelijk aan verkoper ter kennis zijn gebracht.
- 2.5 Eventueel later gemaakte aanvullende afspraken of wijzigingen alsmede (mondelijke) afspraken en/of toezeggingen door personeel van verkoper of namens verkoper gedaan door onze verkopers, agenten, vertegenwoordigers of andere tussenpersonen, binden verkoper slechts indien deze door verkoper schriftelijk zijn bevestigd.

Art. 3 Prijzen

- 3.1 Tenzij anders vermeld geschieden alle prijsopgaven onder voorbehoud van prijswijziging.
- 3.2 Tenzij anders vermeld zijn de prijzen:
 - gebaseerd op de tijdens de offerte respectievelijk orderdatum geldende hoogte van inkooprijzen, lonen, loonkosten, sociale- en overheidslasten, vrachten, assurantiepremies en andere kosten;
 - exclusief de aanlegkosten van leidingen alsmede van hak-, breek-, metsel-, timmer-, stucadoors-, schilder-, behangers-, herstel- of andere bijkomende werkzaamheden;
 - exclusief de kosten van het bedrijfsklaar opstellen daaronder begrepen de aansluiting van de apparatuur aan de leidingen;
 - gebaseerd op levering af bedrijf verkoper, magazijn of andere opslagplaats;
 - exclusief BTW, invoerrechten, andere belastingen, heffingen en rechten;
 - exclusief de kosten van verpakkingen, in- en uitlading, vervoer en verzekering;
 - vermeld in Nederlandse valuta, waarbij eventuele koerswijzigingen worden doorberekend.
- 3.3 Bij stijging van de kosten van materialen, halffabrikaten of diensten die voor de uitvoering van de overeenkomst nodig zijn, van lonen, van werkgeverslasten sociale verzekering, bij aanzienlijke wijziging in valutaverhoudingen, één en ander nadat de overeenkomst tussen partijen tot stand is gekomen, is verkoper gerechtigd de overeengekomen prijzen dienovereenkomstig te verhogen.

Art. 4 Levering en levertijd

- 4.1 Tenzij anders overeengekomen geschiedt levering af bedrijf verkoper. Franco levering geschiedt alleen – tenzij anders is overeengekomen – bij leveringen binnen Nederland, met uitzondering van de Waddeneilanden, vanaf een factuurbedrag van € 1.000,- exclusief BTW.
- 4.2 De overeengekomen leveringstermijnen zullen nimmer zijn te beschouwen als fatale termijn, tenzij uitdrukkelijk anders is overeengekomen. Bij niet-tijdige aflevering dient de wederpartij derhalve verkoper schriftelijk in gebreke te stellen.
- 4.3 Verkoper is gerechtigd om te leveren in gedeelten (deelleveranties), welke verkoper afzonderlijk kan factureren; betaling door de wederpartij dient alsdan plaats te vinden overeenkomstig het hierna bepaalde inzake "Betaling".
- 4.4 Indien de wederpartij de zaken van de vervoerder aanneemt, geldt zulks als bewijs dat de emballage in goede staat is, tenzij door de wederpartij een aantekening van het tegendeel is vermeld op de vrachtbrief of het ontvangstbewijs.
- 4.5 Indien de zaken na het verstrijken van de overeengekomen leveringstijd door de wederpartij niet zijn afgenomen, staan deze zaken voor zijn rekening en risico te zijner beschikking opgeslagen. Na een periode van 4 weken na het verstrijken van de overeengekomen leveringstijd is verkoper gerechtigd de overeenkomst door middel van een buitengerechtigde verklaring te ontbinden en staat het verkoper vrij deze zaken te verkopen. De hiermee gepaard gaande kosten en de eventuele minderopbrengst van deze zaken komen voor rekening van de wederpartij. De opslagkosten bedragen 8% per maand, te berekenen over de factuurwaarde.
- 4.6 Voor goederen welke op termijn (is afname voor een bepaalde datum) worden geleverd, kan verkoper betaling vooraf verlangen.

Art. 5 Afwijkingen/stempels

- 5.1 Met betrekking tot de hoeveelheid af te leveren goederen wordt een afwijking van 5% meer of minder toegelaten.
- 5.2 Met betrekking tot goederen welke speciaal aangemaakt of bestempeld moeten worden, of op andere wijze van een merk- of kenteken moeten worden voorzien is een afwijking van 10% meer of minder toegelaten.
- 5.3 Gegevens omtrent maten, inhoud, gewicht e.d. gelden slechts bij benadering.
- 5.4 De eventueel vervaardigde stempels, gravures e.d., welke noodzakelijk zijn voor het opbrengen van een decor, naam of merkteken blijven eigendom van de betreffende fabrikant en worden niet meegeleverd. De vervaardigingskosten worden in rekening gebracht.

Art. 6 Transport

- 6.1 Verkoper zal, de aard van de te vervoeren zaken in aanmerking nemend, de meest gebruikelijke route en de meest gebruikelijke wijze van verzending kiezen. Verkoper zal zoveel mogelijk met de wensen van koper rekening houden. Hierdoor veroorzaakte extra kosten zijn voor rekening van de wederpartij. Voor hieruit voortvloeiende vertraging is verkoper niet aansprakelijk.
- 6.2 Het transport van de goederen geschiedt in beginsel steeds voor rekening en risico van de wederpartij, zelfs dan wanneer de vervoerder vordert dat op vrachtbrieven, vervoeradressen e.d. de clause voorkomt dat alle vervoersschaden voor rekening en risico van de afzender zijn.

Art. 7 Betaling

- 7.1 Betaling dient te geschieden netto-contant ten tijde en ter plaatse van de aflevering; verkoper is gerechtigd van de wederpartij een deelbetaling bij opdracht te verlangen.
- 7.2 Indien tussen partijen schriftelijk is overeengekomen dat betaling kan geschieden door middel van storting of

overmaking op een door verkoper aangewezen bank- of Postbankrekening, dient betaling te geschieden binnen acht dagen na factuur datum.

- 7.3 De wederpartij kan zich alleen dan op verrekening beroepen, indien hetzij zijn vordering door verkoper wordt erkend, hetzij de gegrondheid van die vordering op eenvoudige wijze is vast te stellen.
- 7.4 Iedere betaling van de wederpartij strekt primair ter voldoening van de door hem verschuldigde interest alsmede van de door verkoper gemaakte invorderingskosten en/of administratiekosten en worden daarna in mindering gebracht op de oudste openstaande rekening.

Art. 8 Te late betaling

- 8.1 Indien de wederpartij de overeengekomen betalingstermijn overschrijdt is de wederpartij van rechtswege in verzuim en is verkoper gerechtigd de wettelijke rente + 2% in rekening te brengen. Voorts zal de wederpartij redelijkerwijs noodzakelijke kosten ter verkrijging van voldoening buiten rechte verschuldigd zijn, waarbij verkoper zal hanteren het incassotarif zoals dat is opgenomen in het door de Nederlandse Orde van Advocaten gehanteerde calculatieschema voor advocaten-declaraties. Indien de incasso van de vordering door verkoper in handen van een advocaat wordt gegeven, zal de wederpartij de door de advocaat aan de verkoper in rekening te brengen kosten moeten vergoeden.
- 8.2 Indien:
- de wederpartij in verzuim is en/of
 - verkoper goede gronden heeft te vrezen, dat de wederpartij niet of niet-tijdig aan zijn betalingsverplichting zal voldoen: zal verkoper, zonder tot enige schadevergoeding gehouden te zijn, en onverminderd alle hem verder toekomende rechten, gerechtigd zijn:
 - vooruitbetaling of zekerheidstelling te verlangen;
 - de uitvoering van de verkoopovereenkomst geheel of gedeeltelijk op te schorten;
 - de overeengekomen betalingstermijnen, al dan niet in andere overeenkomsten, te herroepen, waardoor alle (overige) openstaande vorderingen onmiddellijk opeisbaar worden;
 - zijn verplichtingen uit alle andere overeenkomsten met koper op te schorten. Verkoper zal slechts tot de bovengenoemde maatregelen gerechtigd zijn voorzover de (gevreemde) tekortkoming van de wederpartij deze maatregelen rechtvaardigt.

Art. 9 Overmacht

- 9.1 Tekortkomingen van verkoper in de uitvoering van de overeenkomst kunnen niet aan hem worden toegerekend, indien zij niet te wijten zijn aan zijn schuld, noch krachtens de wet, de overeenkomst of in het verkeer geldende opvattingen voor zijn rekening komen.
- 9.2 Onder overmacht wordt in ieder geval verstaan:
- de omstandigheid dat verkoper een prestatie die van belang is in verband met de door hem zelf te leveren prestatie niet, niet-tijdig of niet-behoorlijk geleverd krijgt;
 - stakingen;
 - storingen in het verkeer;
 - overheidsmaatregelen die verkoper verhinderen zijn verplichtingen tijdig dan wel deugdelijk na te komen;
 - bovenmatig ziekteverzuim.
- 9.3 Indien aflevering/afname door overmacht langer dan één maand wordt vertraagd is ieder der partijen -onder uitsluiting van verdere rechten- bevoegd de verkoopovereenkomst te ontbinden volgens de wet.
- 9.4 De in artikel 9.3. genoemde termijn van één maand is zoveel korter of langer naarmate één van partijen aantoont dat naar maatstaven van redelijkheid en billijkheid ontbinding op een eerder of later tijdstip gerechtvaardigd is.
- 9.5 Indien verkoper bij het intreden van de overmacht al

gedeeltelijk aan zijn verplichtingen heeft voldaan, of slechts gedeeltelijk aan zijn verplichtingen kan voldoen, is hij gerechtigd het reeds geleverde c.q. het leverbare deel afzonderlijk te factureren en is de wederpartij gehouden deze factuur te voldoen als betrof het een afzonderlijk contract. Dit geldt echter niet als het reeds geleverde c.q. leverbare deel geen zelfstandige waarde heeft.

Art. 10 - Garantie

- 10.1 Met inachtneming van hetgeen elders in deze voorwaarden is bepaald, staat verkoper in voor de deugdelijkheid alsmede de kwaliteit van de door hem geleverde, verwerkte en gebruikte materialen.
- 10.2 Indien de wederpartij genoegzaam heeft aangetoond of bewezen dat de geleverde zaak (zaken) of de geleverde materialen niet voldoen aan de in het normale verkeer daaraan te stellen eisen, zal verkoper de, als gevolg daarvan, ontstane gebreken kosteloos herstellen, tenzij verkoper verkiest de geleverde zaak (zaken) of de geleverde materialen te vervangen.
- 10.3 Garantie wordt slechts verstrekt indien en voorzover een garantie schriftelijk is overeengekomen.
- 10.4 Verkoper zal slechts uitvoering geven aan zijn garantieverplichtingen indien en voorzover de betreffende zaken en/of materialen zich binnen de landsgrenzen van Nederland bevinden.
- 10.5 Op gebruikte apparatuur wordt nimmer garantie verstrekt.
- 10.6 Glasbreuk, gebreken ontstaan door normale slijtage, onoordeelkundige behandeling of gebruik voor andere dan normale (bedrijfs)doeleinden, onvoldoende onderhoud en gebreken die zich voordoen na wijziging of reparatie door of namens de wederpartij zelf of door derden, blijven buiten de garantie.
- 10.7 Indien in het kader van de uitvoering van de garantieverplichting verkoper onderdelen vervangt, worden de te vervangen onderdelen eigendom van verkoper.
- 10.8 Indien koper het gekochte heeft meegenomen naar het buitenland is koper gehouden het geleverde op zijn kosten te (doen) bezorgen op het adres van verkoper.
- 10.9 Wanneer verkoper zijn uit deze bepaling voortvloeiende verplichtingen nakomt, heeft hij aan al zijn verplichtingen jegens de wederpartij voldaan en is hij nimmer aansprakelijk voor de door de wederpartij geleden schade.

Art. 11 - Reclames

- 11.1 De wederpartij dient binnen één dag na aflevering te onderzoeken of de afgeleverde zaken aan de verkoopovereenkomst beantwoorden.
- 11.2 De wederpartij kan er geen beroep op doen dat de afgeleverde zaken niet aan de verkoopovereenkomst beantwoorden, indien hij het onderzoek als bedoeld in artikel 11.1 nalaat of verkoper niet binnen de hierna genoemde termijnen van de gebreken in kennis stelt.
- 11.3 Zichtbare gebreken dienen binnen vijf dagen na ontvangst van de zaken, verborgen gebreken onmiddellijk nadat de wederpartij ze heeft ontdekt, doch uiterlijk 6 maanden na aflevering van de zaken schriftelijk te worden gemeld bij verkoper.
- 11.4 Klachten moeten schriftelijk worden ingediend onder vermelding van de bestelgegevens, factuur- en vrachtbriefnummers.
- 11.5 Gereclameerde zaken mogen alleen worden teruggezonden met uitdrukkelijke schriftelijke toestemming van verkoper.
- 11.6 Ingeval van gegronde en correct ingediende klachten is verkoper, zulks te zijner keuze, rekening houdend met de belangen van de weder partij en de aard van de klacht, verplicht tot:
- aflevering van het ontbrekende; of
 - verlening van een prijskorting; of
 - herstel van de afgeleverde zaken; of

- d. vervanging van de afgeleverde zaken; of
 - e. restitutie van de koopprijs tegen teruggave van de afgeleverde zaken.
- 11.7 Verkoper zal deze keuze binnen een redelijke termijn na correcte melding van de klacht door de wederpartij doen en vervolgens zijn verplichtingen binnen een redelijke termijn nakomen, bij gebreke hiervan is de wederpartij bevoegd tussen bovengenoemde verplichtingen van verkoper te kiezen.
- 11.8 Wanneer verkoper zijn uit artikel 11.6 of 11.7 voortvloeiende verplichtingen nakomt, heeft hij aan al zijn verplichtingen jegens de wederpartij voldaan en is hij nimmer aansprakelijk voor de door de wederpartij geleden schade.

Art. 12 - Aansprakelijkheid

- 12.1 Verkoper is jegens koper uitsluitend op de volgende wijze aansprakelijk:
- Voor schade als gevolg van een gebrek in het geleverde is verkoper slechts aansprakelijk voorzover hij hiertegen is verzekerd, dan wel gezien de in de branche geldende gebruiken, verzekerd had behoren te zijn, tot maximaal het bedrag van de verzekeringsuitkering;
 - Voor schade als gevolg van niet tijdige aflevering is verkoper niet aansprakelijk;
 - Voor schade in andere gevallen is de aansprakelijkheid van verkoper beperkt tot de door de wederpartij geleden schade die het rechtstreeks en uitsluitend gevolg is van schuld van verkoper. Deze schade komt slechts voor vergoeding in aanmerking indien verkoper hiertegen verzekerd is, danwel redelijkerwijs, gezien de in de branche geldende gebruiken, verzekerd had behoren te zijn, tot maximaal het bedrag van de verzekeringsuitkering;
 - Verkoper is eveneens aansprakelijk als de schade is veroorzaakt door opzet of grove schuld van verkoper of zijn leidinggevende ondergeschikten.
- 12.2 Bedrijfs schade (bedrijfsstoring, het stilliggen van het bedrijf, derving van inkomsten en dergelijke) door welke oorzaak ook ontstaan, komt nimmer voor vergoeding in aanmerking. De wederpartij dient zich desgewenst tegen deze schade te verzekeren.
- 12.3 De door verkoper te vergoeden schade zal worden gematigd wanneer de door de wederpartij te betalen prijs niet in verhouding staat tot de door de wederpartij geleden schade.
- 12.4 De wederpartij is zelf aansprakelijk voor alle schade ten gevolge van verlies, diefstal, brand of beschadiging van de door verkoper afgeleverde zaken vanaf het moment van aflevering.

Art. 13 - Eigendomsvoorbehoud

- 13.1 De afgeleverde zaken worden eerst eigendom van de wederpartij als deze al datgene heeft gedaan wat verkoper uit hoofde van alle (eerdere of latere) koopovereenkomsten met de wederpartij en/of door verkoper in dat kader verrichte diensten of werkzaamheden te vorderen mocht hebben of mocht krijgen, waaronder begrepen vorderingen tot schadevergoeding wegens het niet nakomen van de hier bedoelde overeenkomsten, waaronder rente en kosten alsmede de in artikel 13.7 gefixeerde schadevergoeding.
- 13.2 De wederpartij is binnen redelijke grenzen verplicht zijn medewerking te verlenen bij alle maatregelen die verkoper ter bescherming van de afgeleverde zaken en/of zijn eigendomsrecht op die zaken wil treffen.
- 13.3 Indien derden enig recht op de onder eigendomsvoorbehoud afgeleverde zaken willen vestigen of doen gelden, is de wederpartij verplicht verkoper onmiddellijk hiervan schriftelijk op de hoogte te stellen.
- 13.4 Zolang het eigendomsvoorbehoud geldt is de wederpartij uitsluitend bevoegd tot eigen be- /verwerking of doorlevering van de afgeleverde zaken in de normale uitoefening van zijn bedrijf.
- 13.5 Na be-/verwerking van bedoelde zaken wordt verkoper (mede)

eigenaar van de daaruit gevormde of mede daaruit gevormde zaken en zal de wederpartij deze zaken automatisch gaan houden voor verkoper.

- 13.6 Indien verkoper niettegenstaande het bepaalde in artikel 13.5. niet de eigendom van de door de wederpartij gevormde zaken verkrijgt, zal de wederpartij op eerste verzoek van verkoper alle vereiste medewerking verlenen die nodig is voor het vestigen van een al dan niet bezitloos pandrecht op de betreffende zaken ten behoeve van verkoper.
- 13.7 Indien de wederpartij zijn betalingsverplichtingen niet of niet-tijdig nakomt of indien gegronde vrees bestaat dat dit zal gebeuren, is verkoper gerechtigd afgeleverde zaken waarop het in artikel 13 lid 1 bedoelde eigendomsvoorbehoud rust, de in artikel 13.5. bedoelde zaken, alsmede de in artikel 13.6. bedoelde zaken waarop het bezitloos pandrecht rust bij de wederpartij of derden, die de zaak voor de wederpartij houden, weg te halen of weg te doen halen. De wederpartij is verplicht hiervoor al zijn medewerking te verlenen op straffe van een boete van 10% van het door hem aan verkoper verschuldigde, met een minimum van € 500, per dag of gedeelte daarvan dat koper in gebreke is met de nakoming van deze verplichting.

Art. 14 - Toepasselijk recht

- 14.1 De overeenkomsten tussen verkoper en wederpartij worden uitsluitend beheerst door het Nederlandse recht, met uitsluiting van de eenvormige wetten inzake de Internationale Koop van Roerende Lichamelijke Zaken.
- 14.2 Ter zake van de uitleg van internationale handelstermijnen zijn de "Incoterms", zoals samengesteld door de Internationale Kamer van Koophandel te Parijs van toepassing.

Art. 15 - Geschillen

- 15.1 Alle geschillen zullen worden beslecht door de bevoegde burgerlijke rechter, zulks met inachtneming van de ter zake vigerende competentieregels.

Für die LIEFERUNG VON MECHANISCHEN, ELEKTRISCHEN UND ELEKTRONISCHEN ERZEUGNISSEN - Brüssel, März 2012

PRÄAMBEL

1. Diese Allgemeinen Bedingungen gelten, wenn sie die Parteien schriftlich oder anderweitig vereinbaren. Änderungen oder Abweichungen davon sind schriftlich zu vereinbaren.

BEGRIFFSBESTIMMUNGEN

2. In diesen Allgemeinen Bedingungen sind die nachstehenden Begriffe wie folgt zu verstehen:
 - "Vertrag": die zwischen den Parteien schriftlich vereinbarte Übereinkunft über die Lieferung des Liefergegenstandes sowie aller Anhänge, einschließlich ggf. Vereinbarter, schriftlicher Ergänzungen und Zusätze zu den vorgenannten Unterlagen.
 - "Grobe Fahrlässigkeit": ein Handeln oder Unterlassen, bei dem die betreffende Partei entweder die verkehrsbliche Sorgfalt im Hinblick auf den Eintritt schwerwiegender Folgen nicht walten ließ, die eine verantwortungsbewusste Vertragspartei normalerweise vorausgesehen hätte, oder bei dem die betreffende Partei bewusst die Folgen eines solchen Handelns oder Unterlassens außer Acht gelassen hat.
 - "Schriftlich": mittels Schriftstück, das von den Parteien unterzeichnet ist, oder mittels Schreiben, Fax, Email oder anderer, von den Parteien vereinbarter Form.
 - "Liefergegenstand": die gemäß dem Vertrag zu liefernden Waren, einschließlich Software und Dokumentation.

PRODUKTINFORMATION

3. Die in allgemeinen Produktdokumentationen und Preislisten enthaltenen Angaben und Informationen sind nur soweit verbindlich, als der Vertrag ausdrücklich und schriftlich auf sie Bezug nimmt.

ZEICHNUNGEN UND TECHNISCHE INFORMATIONEN

4. Stellt eine Partei der anderen Partei Zeichnungen und technische Unterlagen über den Liefergegenstand oder seine Herstellung vor oder nach Vertragsschluss zur Verfügung, bleiben diese Eigentum der sie vorlegenden Partei. Erhält eine Partei Zeichnungen, technische Unterlagen oder andere technische Informationen, so darf sie diese ohne die Zustimmung der anderen Partei nicht für einen anderen Zweck nutzen, als für den sie geliefert wurden. Sie dürfen nicht ohne Zustimmung der vorlegenden Partei für andere Zwecke genutzt, kopiert, reproduziert, an Dritte weitergegeben oder bekannt gegeben werden.
5. Der Lieferer stellt spätestens zum Zeitpunkt der Lieferung kostenlos Angaben und Zeichnungen zur Verfügung, die es dem Besteller ermöglichen, den Liefergegenstand aufzustellen, in Betrieb zu nehmen, zu unterhalten und zu warten. Die vereinbarte Anzahl solcher Anleitungen und Zeichnungen ist zu übergeben, jedoch mindestens jeweils ein Exemplar. Der Lieferer ist nicht zur Beschaffung von Werkstattzeichnungen für den Liefergegenstand oder für Ersatzteile verpflichtet.

ABNAHMEPRÜFUNGEN

6. In dem Vertrag vereinbarte Abnahmeprüfungen werden mangels abweichender Vereinbarung am Herstellungsort während der normalen Arbeitszeit durchgeführt. Enthält der Vertrag keine Bestimmungen über technische Anforderungen, so ist für die Prüfungen die im Herstellungsland bestehende allgemeine Praxis des betreffenden Industriezweiges maßgeblich.
7. Der Lieferer muss den Besteller schriftlich so rechtzeitig von der Abnahmeprüfung verständigen, dass dieser bei den Prüfungen vertreten werden kann. Wird der Besteller nicht vertreten, so erhält er vom Lieferer ein Prüfungsprotokoll, dessen Richtigkeit er nicht mehr bestreiten kann.

8. Erweist sich der Liefergegenstand bei den Abnahmeprüfungen als vertragswidrig, so hat der Lieferer unverzüglich jeglichen Mangel zu beheben, um den vertragsgemäßen Zustand des Liefergegenstandes herzustellen. Der Besteller kann eine Wiederholung der Prüfungen nur in Fällen wesentlicher Mängel verlangen.
9. Der Lieferer trägt alle Kosten für die am Herstellungsort durchgeführten Abnahmeprüfungen. Der Besteller hat jedoch für seine Vertreter sämtliche in Verbindung mit den Prüfungen entstandenen Reise- und Lebenshaltungskosten zu tragen.

LIEFERUNG. GEFAHRÜBERGANG

10. Die vereinbarten Lieferklauseln sind nach den bei Vertragsschluss geltenden INCOTERMS® auszulegen. Mangels besonderer Lieferklausel im Vertrag gilt der Liefergegenstand als "Frei Frachtführer" (FCA) an dem vom Lieferer benannten Ort geliefert. Verpflichtet sich der Lieferer im Falle einer FCA-Lieferung auf Verlangen des Bestellers dazu, den Liefergegenstand an seinen Bestimmungsort zu versenden, so geht die Gefahr spätestens zu dem Zeitpunkt über, an dem der Liefergegenstand an den ersten Spediteur übergeben wird. Teillieferungen sind mangels abweichender Vereinbarung nicht gestattet.

LIEFERFRIST. VERZÖGERUNGEN

11. Haben die Parteien statt eines festen Liefertermins eine Frist vereinbart, innerhalb der die Lieferung zu erfolgen hat, dann beginnt die Frist mit Abschluss des Vertrages sowie der Erfüllung aller anderen vereinbarten Vorbedingungen durch den Besteller, wie Erledigung offizieller Formalitäten, Begleichung der bei Vertragsschluss fälligen Zahlungen und Sicherungsmittel.
12. Kann der Lieferer absehen, dass er den Liefergegenstand nicht innerhalb der Lieferfrist liefern können wird, so hat er den Besteller unverzüglich und schriftlich davon in Kenntnis zu setzen, ihm die Gründe hierfür mitzuteilen sowie nach Möglichkeit den voraussichtlichen Lieferzeitpunkt zu nennen. Unterlässt der Lieferer eine solche Mitteilung, ist der Besteller berechtigt, Ersatz aller weiteren Kosten zu verlangen, die ihm aufgrund des Umstandes entstehen, dass er eine solche Mitteilung nicht erhalten hat.
13. Verzögert sich die Lieferung durch einen in Ziffer 41 aufgeführten Umstand oder durch ein Handeln oder Unterlassen des Bestellers, wozu auch die Einstellung der Leistung nach Ziffer 21 und Ziffer 44 oder andere auf den Besteller zurückzuführende Umstände zählen, so ist der Lieferer berechtigt, die Lieferfrist unter Berücksichtigung aller im Einzelfall vorliegenden Umständen im erforderlichen Maße zu verlängern. Diese Bestimmung gilt unabhängig davon, ob der Grund für die Verzögerung vor oder nach dem vereinbarten Liefertermin eintritt.
14. Wird der Liefergegenstand nicht zum Liefertermin geliefert, so hat der Besteller ab dem Zeitpunkt Anspruch auf Zahlung eines pauschalierten Schadenersatzes, zu dem die Lieferung hätte erfolgen müssen.

Der pauschalierte Schadenersatz ist auf 0,5 v.H. des Kaufpreises für jede angefangene Woche der Verzögerung festgesetzt. Der pauschalierte Schadenersatz kann 7,5 v.H. des Kaufpreises nicht überschreiten.

Verzögert sich nur ein Teil des Liefergegenstandes, so wird der pauschalierte Schadenersatz aufgrund des Kaufpreises bestimmt, der dem Teil des Liefergegenstandes entspricht, der durch die Verzögerung nicht wie von den Parteien vorgesehen genutzt werden kann.

Der pauschalierte Schadenersatz wird mit der schriftlichen Geltendmachung des Bestellers fällig, jedoch nicht bevor die Gesamtlieferung abgeschlossen oder der Vertrag nach Ziffer 15 beendet worden ist.



Der Besteller verliert seinen Anspruch auf Zahlung des pauschalierten Schadenersatzes, wenn er diesen nicht schriftlich innerhalb von sechs Monaten ab dem Zeitpunkt geltend macht, zu dem die Lieferung hätte erfolgen sollen.

15. Ist der Besteller wegen der Länge der Verzögerungsberechtigt, den Höchstbetrag an pauschalierem Schadenersatz nach Ziffer 14 zu fordern, und ist der Liefergegenstand noch nicht geliefert, so kann er dem Lieferer schriftlich eine letzte angemessene Lieferfrist von mindestens einer Woche setzen.

Liefert der Lieferer nicht innerhalb dieser letzten Frist aus einem Grund, der nicht auf den Besteller zurückzuführen ist, so kann der Besteller durch schriftliche Mitteilung an den Lieferer von dem Vertrag hinsichtlich desjenigen Teiles des Liefergegenstandes zurücktreten, welcher aufgrund der Lieferverzögerung durch den Lieferer nicht wie von den Parteien vorgesehen genutzt werden kann.

Tritt der Besteller von dem Vertrag zurück, so hat er einen Anspruch auf Entschädigung für den ihm aufgrund der Verzögerung durch den Lieferer entstehenden Schaden, einschließlich etwaiger indirekter Schäden oder Folgeschäden. Die Gesamthöhe der Entschädigung, einschließlich des pauschalierten Schadenersatzes nach Ziffer 14, darf 15 v.H. des Teil-Kaufpreises nicht überschreiten, der dem Teil des Liefergegenstandes entspricht, hinsichtlich dessen der Besteller von dem Vertrag zurückgetreten ist.

Der Besteller ist weiterhin berechtigt, den Vertrag durch schriftliche Mitteilung an den Verkäufer zu beenden, wenn es sich aus den Umständen zweifelsfrei ergibt, dass sich die Lieferung um einen Zeitraum verzögern wird, aufgrund dessen dem Besteller der Höchstsatz an Schadenersatz gemäß Ziffer 14 zustünde. Wird der Vertrag aus diesem Grund beendet, steht dem Besteller der Höchstsatz an pauschalierem Schadenersatz sowie eine Entschädigung gemäß dem dritten Absatz dieser Ziffer 15 zu.

16. Weitergehende Ansprüche über den pauschalierten Schadenersatz nach Ziffer 14 und den Rücktritt von dem Vertrag mit begrenzter Entschädigung nach Ziffer 15 hinaus können seitens des Bestellers im Falle der Verzögerung durch den Lieferer nicht geltend gemacht werden. Alle anderen Ansprüche gegenüber dem Lieferer im Hinblick auf Verzögerung sind ausgeschlossen, sofern nicht grobe Fahrlässigkeit seitens des Lieferers vorliegt.
17. Kann der Besteller absehen, dass ihm die Annahme des Liefergegenstandes zum Liefertermin unmöglich sein wird, so hat er den Lieferer unverzüglich schriftlich davon in Kenntnis zu setzen, ihm den Grund dafür mitzuteilen sowie ihm nach Möglichkeit den Zeitpunkt zu nennen, zu dem er die Lieferung annehmen kann.

Nimmt der Besteller die Lieferung zum Liefertermin nicht an, so hat er dennoch den Teil des zum Liefertermin fälligen Kaufpreises zu entrichten, als ob die Lieferung zum Liefertermin erfolgt wäre. Der Lieferer hat für die Einlagerung des Liefergegenstandes auf Kosten und Gefahr des Bestellers zu sorgen. Weiterhin hat der Lieferer auf Verlangen des Bestellers den Liefergegenstand auf Kosten des Bestellers zu versichern.

18. Beruht die Nichtannahme durch den Besteller nicht auf einem in Ziffer 41 vorgesehenen Umstand, kann der Lieferer den Besteller schriftlich zur Annahme der Lieferung innerhalb einer angemessenen letzten Frist auffordern.

Nimmt der Besteller aus einem Grund, der nicht auf den Lieferer zurückzuführen ist, die Lieferung nicht innerhalb einer solchen Frist an, kann der Lieferer schriftlich ganz oder teilweise von dem Vertrag zurücktreten. Der Lieferer hat dann Anspruch auf Ersatz des ihm durch den Verzug des Bestellers entstandenen Schadens, einschließlich indirekter Schäden und Folgeschäden. Die Gesamthöhe der Entschädigung darf den Kaufpreis nicht überschreiten, der dem Teil des Liefergegenstandes entspricht, hinsichtlich dessen der Vertrag aufgelöst wird.

ZAHLUNGEN

19. Zahlungen haben innerhalb einer Frist von 30 Tagen ab Rechnungsdatum zu erfolgen.

Mangels abweichender Vereinbarung ist ein Drittel des Kaufpreises bei Vertragsschluss fällig und ein Drittel, nachdem der Lieferer dem Besteller die Versandbereitschaft des Liefergegenstandes oder wesentlicher Teile des Liefergegenstandes erklärt hat. Der verbleibende Teil des Kaufpreises ist bei Abschluss der Gesamtlieferung zahlbar.

20. Ungeachtet des verwendeten Zahlungsmittels gilt die Zahlung erst dann als erfolgt, wenn der fällige Betrag unwiderruflich dem Konto des Lieferers gutgeschrieben wird.

21. Ist der Besteller mit seinen Zahlungen im Rückstand, so kann der Lieferer vom Tag der Fälligkeit an Verzugszinsen sowie Ersatz der Betriebskosten fordern. Mangels abweichender Vereinbarung der Parteien gilt ein Zinssatz von 8 Prozentpunkten über dem Satz der Spitzenrefinanzierungsfazilität der Europäischen Zentralbank als vereinbart. Die zu ersetzenden Betriebskosten betragen 1 v.H. des Betrages, für den Verzugszinsen fällig werden.

Im Falle verzögerter Zahlung oder im Falle einer nicht fristgerechten Gestellung einer vereinbarten Sicherheit durch den Besteller kann der Lieferer, nach schriftlicher Mitteilung an den Besteller, die Erfüllung seiner eigenen Verpflichtungen bis zum Erhalt der Zahlungen bzw. bis zur Gestellung der Sicherheit einstellen.

Ist der Besteller mit seinen fälligen Zahlungen mehr als drei Monate im Rückstand, so kann der Lieferer durch schriftliche Mitteilung an den Besteller vom Vertrag zurücktreten und, zusätzlich zu den Zinsen und Betriebskosten gemäß dieser Ziffer, vom Besteller Ersatz des ihm entstandenen Schadens verlangen. Ein solcher Schadenersatz darf den vereinbarten Kaufpreis nicht überschreiten.

EIGENTUMSVORBEHALT

22. Der Liefergegenstand bleibt bis zur vollständigen Bezahlung Eigentum des Lieferers, sofern ein solcher Eigentumsvorbehalt nach dem jeweiligen Recht wirksam ist.

Auf Verlangen des Lieferers hat ihn der Besteller bei seinen Bemühungen umfassend zu unterstützen, das Eigentumsrecht des Lieferers an dem Liefergegenstand zu schützen.

Der Eigentumsvorbehalt berührt nicht die Bestimmungen über den Gefahrübergang nach Ziffer 10.

HAFTUNG FÜR MÄNGEL

23. Nach Maßgabe der Ziffern 24-39 ist der Lieferer verpflichtet, sämtliche Mängel bzw. Abweichungen zu beheben (nachfolgend „Mangel/Mängel“ genannt), die auf einem Fehler der Konstruktion, des Materials oder der Ausführung beruhen.
24. Der Lieferer haftet nicht für Mängel, die auf vom Besteller beigestellten Materialien oder einer vom Besteller vorgeschriebenen oder näher bestimmten Konstruktion beruhen.
25. Der Lieferer haftet nur für solche Mängel, die unter den vertraglich vorgesehenen Betriebsbedingungen und bei ordnungsgemäßem Gebrauch des Liefergegenstandes auftreten.
26. Der Lieferer haftet nicht für Mängel, die auf nach dem Gefahrübergang eintretende Umstände zurückzuführen sind, wie z.B. Mängel aufgrund von schlechter Instandhaltung, unsachgemäßer Aufstellung, fehlerhafter Reparatur durch den Besteller oder auf Änderungen ohne schriftliche Zustimmung des Lieferers. Der Lieferer haftet weder für normale Abnutzung noch für Verschlechterung.

27. Die Haftung des Lieferers ist auf Mängel beschränkt, die innerhalb eines Jahres nach der Lieferung auftreten. Übersteigt die Nutzung des Liefergegenstandes den vereinbarten Rahmen, verkürzt sich die Frist angemessen.
28. Wird ein Mangel in einem Teil des Liefergegenstandes behoben, haftet der Lieferer ein Jahr für Mängel der gelieferten Ersatzteile oder reparierten Teile zu den gleichen Bedingungen wie für den ursprünglichen Liefergegenstand. Für alle anderen Teile des Liefergegenstandes verlängert sich die unter Ziffer 27 genannte Frist lediglich soweit und solange die durch den Mangel verursachte Nutzungsunterbrechung des Liefergegenstandes andauert.
29. Der Besteller hat einen auftretenden Mangel unverzüglich schriftlich gegenüber dem Lieferer zu rügen. Eine solche Mängelrüge hat in jedem Fall innerhalb von zwei Wochen nach Ablauf der unter Ziffer 27 bestimmten Frist bzw. der verlängerten Frist(en) gemäß Ziffer 28 zu erfolgen.
- Die Rüge hat den Mangel zu beschreiben. Rügt der Besteller den Mangel gegenüber dem Lieferer nicht schriftlich innerhalb der in Absatz 1 dieser Ziffer festgelegten Fristen, verliert der Besteller sein Recht auf Behebung des Mangels.
- Könnte der Mangel Schäden verursachen, hat der Besteller den Lieferer unverzüglich schriftlich in Kenntnis zu setzen. Der Besteller trägt die Gefahr für Schäden am Liefergegenstand, die sich aus einem Unterlassen der Mitteilung ergeben. Der Besteller hat die zur Schadensbegrenzung angemessenen Maßnahmen zu ergreifen und insoweit den Anweisungen des Lieferers Folge zu leisten.
30. Nach Erhalt der Mängelrüge nach Ziffer 29 hat der Lieferer den Mangel unverzüglich und auf seine Kosten gemäß Ziffern 23 - 39 zu beheben. Die Mängelbeseitigung ist zeitlich so festzulegen, dass die Abläufe des Bestellers nicht unnötig beeinträchtigt werden. Der Mangel ist grundsätzlich am Standort des Liefergegenstandes zu beheben, sofern der Lieferer nicht die Zusendung in sein Werk oder an einen anderen von ihm benannten Ort für geeigneter hält.
- Lässt sich der Mangel durch Ersatz oder Reparatur eines mangelhaften Teiles beheben und bedarf der Aus- und Einbau des Teiles keiner besonderen Fachkenntnisse, kann der Lieferer den Versand des mangelhaften Teiles in sein Werk oder an einen anderen von ihm benannten Ort verlangen. In diesem Fall endet die Verpflichtung des Lieferers bezüglich des Mangels mit der Lieferung des ordnungsgemäß reparierten oder ausgetauschten Teiles an den Besteller.
31. Der Besteller hat auf eigene Kosten dem Lieferer den Zugang zu dem Liefergegenstand zu ermöglichen und für etwaige Eingriffe in Bezug auf Ausrüstungsgegenstände, die nicht zu dem Liefergegenstand gehören, Sorge zu tragen, soweit dies für die Behebung des Mangels notwendig ist.
32. Mangels abweichender Vereinbarung erfolgt der notwendige Transport des Liefergegenstandes oder der Teile des Liefergegenstandes zum und vom Lieferer im Zusammenhang mit der Behebung von Mängeln, für die der Lieferer haftet, auf Gefahr und Kosten des Lieferers. Der Besteller hat bei einem solchen Transport die Anweisungen des Lieferers zu befolgen.
33. Mangels abweichender Vereinbarung hat der Besteller alle zusätzlichen Kosten zu tragen, die dem Lieferer bei der Behebung des Mangels aufgrund der Tatsache entstehen, dass der Standort des Liefergegenstandes von dem bei Vertragsschluss als Ort der Lieferung durch den Lieferer an den Besteller angegebenen Bestimmungsort oder - wenn kein Bestimmungsort angegeben war - von dem Lieferort abweicht.
34. Ersetzte mangelhafte Teile sind dem Lieferer zur Verfügung zu stellen und gehen in sein Eigentum über.
35. Hat der Besteller den Mangel nach Ziffer 29 gerügt und ist kein Mangel festzustellen, für den der Lieferer haftet, so hat der Besteller dem Lieferer die Kosten zu ersetzen, die dem Lieferer durch eine solche Rüge entstehen.
36. Kommt der Lieferer seiner Verpflichtung nach Ziffer 30 nicht nach, so kann der Besteller dem Lieferer schriftlich eine letzte, angemessene Frist von mindestens einer Woche setzen, innerhalb derer der Lieferer seinen Verpflichtungen nachzukommen hat.
- Erfüllt der Lieferer seine Verpflichtungen innerhalb dieser letzten Frist nicht, kann der Besteller die notwendigen Reparaturen selbst oder von einem Dritten auf Kosten und Gefahr des Lieferers vornehmen lassen.
- Wurde die Reparatur erfolgreich vom Besteller oder einem Dritten durchgeführt, so sind alle Ansprüche des Bestellers hinsichtlich dieses Mangels gegenüber dem Lieferer mit Erstattung der dem Besteller entstandenen angemessenen Kosten abgegolten.
37. Schlägt eine gemäß Ziffer 36 durchgeführte Reparatur fehl,
- so kann der Besteller eine dem geminderten Wert des Liefergegenstandes entsprechende Minderung des Kaufpreises verlangen, wobei die Minderung in keinem Fall mehr als 15 v.H. des Kaufpreises überschreiten darf; oder
 - ist der Mangel so grundlegend, dass der Besteller sein Interesse an dem Vertrag in Bezug auf den Liefergegenstand oder einen wesentlichen Teil davon verliert, so kann der Besteller nach schriftlicher Mitteilung an den Lieferer in Bezug auf den Teil des Liefergegenstandes vom Vertrag zurücktreten, der aufgrund des Mangels nicht wie von den Parteien vorgesehen genutzt werden kann. Der Besteller hat dann Anspruch auf Ersatz seiner Einbußen, Kosten und Schäden bis zu einem Betrag von maximal 15 v.H. des Teil-Kaufpreises, der dem Teil des Liefergegenstandes entspricht, hinsichtlich dessen der Besteller von dem Vertrag zurückgetreten ist.
38. Unbeschadet der Bestimmungen nach Ziffer 23-37 ist die Haftung des Lieferers für Mängel an jeglichem Teil des Liefergegenstandes auf ein Jahr ab Ende der in Ziffer 27 festgelegten Haftungsdauer bzw. dem Ende einer etwaig von den Parteien vereinbarten, abweichenden Haftungsdauer beschränkt.
39. Vorbehaltlich der Bestimmungen nach Ziffer 23-38 haftet der Lieferer nicht für Mängel. Dies gilt für jeden durch den Mangel verursachten Schaden, einschließlich Produktionsstillstand, entgangenen Gewinn und andere indirekte Schäden. Die Haftungsbeschränkung des Lieferers gilt nicht bei grober Fahrlässigkeit.

HAFTUNGSTEILUNG FÜR DURCH DEN LIEFERGEGENSTAND VERURSACHTE SCHÄDEN

40. Der Lieferer haftet nicht für Sachschäden, die vom Liefergegenstand nach erfolgter Lieferung verursacht werden, wenn der Liefergegenstand im Besitz des Bestellers ist. Weiterhin übernimmt der Lieferer keinerlei Haftung für Schäden an den vom Besteller gefertigten Erzeugnissen oder an Waren, die ein vom Besteller gefertigtes Erzeugnis beinhalten.
- Wird der Lieferer von einem Dritten für Sachschäden im Sinne des vorangegangenen Absatzes zur Haftung herangezogen, so hat der Besteller den Lieferer zu entschädigen, zu verteidigen und schadlos zu halten.
- Macht ein Dritter einen in dieser Ziffer beschriebenen Anspruch gegen eine der Parteien geltend, so hat diese Partei die andere Partei hiervon unverzüglich und schriftlich in Kenntnis zu setzen.
- Der Lieferer und der Besteller sind verpflichtet, sich jeweils von einem Gericht oder Schiedsgericht vorladen zu lassen, das die gegen eine der Parteien erhobenen Schadenersatzansprüche wegen des angeblich durch den Liefergegenstand verursachten Schadens



prüft. Die Haftung zwischen dem Lieferer und dem Besteller unterliegt jedoch den Bestimmungen der Ziffer 46.

Die Haftungsbegrenzung des Lieferers gemäß dem ersten Absatz dieser Ziffer gilt nicht im Falle grober Fahrlässigkeit durch den Lieferer.

HÖHERE GEWALT

41. Jede Partei ist berechtigt, ihre vertraglichen Pflichten insoweit einzustellen, wie diese Erfüllung durch höhere Gewalt unmöglich gemacht oder unangemessen erschwert werden; hierzu zählen: Arbeitskonflikte und alle vom Parteiwillen unabhängige Umstände wie Brand, Krieg, allgemeine Mobilmachung, Aufstand, Requisition, Beschlagnahme, Embargo, Einschränkungen des Energieverbrauchs, Devisen- und Exportbeschränkungen, Epidemien, Naturkatastrophen, extreme Naturereignisse, terroristische Akte sowie mangelhafte oder verzögerte Lieferungen durch Subunternehmer aufgrund der in dieser Ziffer aufgeführten Umstände.

Ein vor oder nach Vertragsschluss eintretender Umstand gemäß dieser Ziffer berechtigt nur insoweit zur Einstellung, als seine Auswirkungen auf die Erfüllung des Vertrages bei Vertragsschluss noch nicht vorhersehbar waren.

42. Die sich auf höhere Gewalt berufende Partei hat die andere Partei unverzüglich und schriftlich vom Eintritt und dem Ende eines solchen Umstandes in Kenntnis zu setzen. Unterlässt eine Partei eine solche Mitteilung, ist die andere Partei berechtigt, Ersatz aller zusätzlichen Kosten zu verlangen, die ihr aufgrund des Umstandes entstehen, dass sie eine solche Mitteilung nicht erhalten hat.

Hindert höhere Gewalt den Besteller an der Erfüllung seiner Pflichten, hat er den Lieferer für aufgewendete Kosten zur Sicherung und zum Schutz des Liefergegenstandes zu entschädigen.

43. Ungeachtet aller in diesen Allgemeinen Bedingungen festgelegten Auswirkungen hat jede Partei das Recht, von dem Vertrag durch schriftliche Mitteilung an die andere Partei zurückzutreten, falls die Einstellung der Erfüllung des Vertrages nach Ziffer 41 länger als sechs Monate andauert.

VORHERSEHBARE NICHTERFÜLLUNG

44. Unbeschadet anders lautender Regelungen in diesen Allgemeinen Bedingungen bezüglich Einstellung der Erfüllung, hat jede Partei das Recht, die Erfüllung ihrer vertraglichen Pflichten einzustellen, wenn sich aus den Umständen zweifelsfrei ergibt, dass die andere Partei ihre Pflichten nicht erfüllen wird. Eine die Erfüllung ihrer vertraglichen Pflichten einstellende Partei hat die andere Partei unverzüglich und schriftlich davon in Kenntnis zu setzen.

FOLGESCHÄDEN

45. Vorbehaltlich abweichender Bestimmungen in diesen Allgemeinen Bedingungen ist die Haftung der einen Partei gegenüber der anderen Partei für Produktionsstillstand, entgangenen Gewinn, Nutzungsausfall, Vertragseinbußen oder jeden anderen Folgeschaden oder indirekten Schaden ausgeschlossen.

STREITIGKEITEN UND ANWENDBARES RECHT

46. Alle sich in Verbindung mit oder aus dem Vertrag ergebenden Streitigkeiten werden nach der Schiedsordnung der Internationalen Handelskammer von einem oder mehreren Schiedsrichter/n endgültig entschieden, der/die gemäß dieser Ordnung ernannt wird/werden.

47. Der Vertrag unterliegt dem materiellen Recht des Landes des Lieferers.

Dies ist eine Orgalime-Veröffentlichung. Orgalime ist der europäische Verband der Maschinenbau-, Elektro-, und Metallverarbeitungsindustrie.

Alle Rechte vorbehalten ©

Editeur responsable :
Adrian Harris, Director General
ORGALIME – The European Engineering Industries Association
Diamant Building, Boulevard A Reyers 80, B-1030 Brussels
Tel: +32 2 706 82 35
Fax: +32 2 706 82 50
secretariat@orgalime.org
www.orgalime.org

For the SUPPLY OF MECHANICAL, ELECTRICAL AND ELECTRONIC PRODUCTS - Brussels, March 2012

1. These General Conditions shall apply when the parties agree In Writing or otherwise thereto. Any modifications of or deviations from them must be agreed In Writing.

DEFINITIONS

2. In these General Conditions the following terms shall have the meanings hereunder assigned to them:
 - "Contract": the agreement In Writing between the parties concerning supply of the Product and all appendices, including agreed amendments and additions In Writing to the said documents;
 - "Gross Negligence": an act or omission implying either a failure to pay due regard to serious consequences, which a conscientious contracting party would normally foresee as likely to ensue, or a deliberate disregard of the consequences of such an act or omission;
 - "In Writing": communication by document signed by both parties or by letter, fax, electronic mail and by such other means as are agreed by the parties;
 - "the Product": the object(s) to be supplied under the Contract, including software and documentation.

PRODUCT INFORMATION

3. All information and data contained in general product documentation and price lists shall be binding only to the extent that they are by reference In Writing expressly included in the Contract.

DRAWINGS AND TECHNICAL INFORMATION

4. All drawings and technical documents relating to the Product or its manufacture submitted by one party to the other, prior or subsequent to the formation of the Contract, shall remain the property of the submitting party.

Drawings, technical documents or other technical information received by one party shall not, without the consent of the other party, be used for any other purpose than that for which they were provided. They may not, without the consent of the submitting party, otherwise be used or copied, reproduced, transmitted or communicated to a third party.

5. The Supplier shall, not later than at the date of delivery, provide free of charge information and drawings which are necessary to permit the Purchaser to install, commission, operate and maintain the Product. Such information and drawings shall be supplied in the number of copies agreed upon or at least one copy of each. The Supplier shall not be obliged to provide manufacturing drawings for the Product or for spare parts

ACCEPTANCE TESTS

6. Acceptance tests provided for in the Contract shall, unless otherwise agreed, be carried out at the place of manufacture during normal working hours. If the Contract does not specify the technical requirements, the tests shall be carried out in accordance with general practice in the appropriate branch of industry concerned in the country of manufacture.
7. The Supplier shall notify the Purchaser In Writing of the acceptance tests in sufficient time to permit the Purchaser to be represented at the tests. If the Purchaser is not represented, the test report shall be sent to the Purchaser and shall be accepted as accurate.
8. If the acceptance tests show the Product not to be in accordance with the Contract, the Supplier shall without delay remedy any deficiencies in order to ensure that the Product complies with the

Contract. New tests shall then be carried out at the Purchaser's request, unless the deficiency was insignificant.

9. The Supplier shall bear all costs for acceptance tests carried out at the place of manufacture. The Purchaser shall however bear all traveling and living expenses for his representatives in connection with such tests.

DELIVERY. PASSING OF RISK

10. Any agreed trade term shall be construed in accordance with the INCOTERMS® in force at the formation of the Contract. If no trade term has been specifically agreed, the delivery shall be Free Carrier (FCA) at the place named by the Supplier. If, in the case of delivery Free Carrier, the Supplier, at the request of the Purchaser, undertakes to send the Product to its destination, the risk will pass not later than when the Product is handed over to the first carrier. Partial delivery shall not be permitted, unless otherwise agreed.

TIME FOR DELIVERY. DELAY

11. If the parties, instead of specifying the date for delivery, have specified a period of time within which delivery shall take place, such period shall start to run as soon as the Contract is entered into and all agreed preconditions to be fulfilled by the Purchaser have been satisfied, such as official formalities, payments due at the formation of the Contract and securities.
12. If the Supplier anticipates that he will not be able to deliver the Product at the time for delivery, he shall forthwith notify the Purchaser thereof In Writing, stating the reason and, if possible, the time when delivery can be expected. If the Supplier fails to give such notice, the Purchaser shall be entitled to compensation for any additional costs which he incurs and which he could have avoided had he received such notice.
13. If delay in delivery is caused by any of the circumstances mentioned in Clause 41, by an act or omission on the part of the Purchaser, including suspension under Clauses 21 and 44, or any other circumstances attributable to the Purchaser, the Supplier shall be entitled to extend the time for delivery by a period which is necessary having regard to all the circumstances of the case. This provision shall apply regardless of whether the reason for the delay occurs before or after the agreed time for delivery.
14. If the Product is not delivered at the time for delivery, the Purchaser shall be entitled to liquidated damages from the date on which delivery should have taken place. The liquidated damages shall be payable at a rate of 0.5 percent of the purchase price for each commenced week of delay. The liquidated damages shall not exceed 7.5 per cent of the purchase price. If only part of the Product is delayed, the liquidated damages shall be calculated on that part of the purchase price which is attributable to such part of the Product as cannot in consequence of the delay be used as intended by the parties. The liquidated damages shall become due at the Purchaser's demand In Writing but not before delivery has been completed or the Contract is terminated under Clause 15.

The Purchaser shall forfeit his right to liquidated damages if he has not lodged a claim In Writing for such damages within six months after the time when delivery should have taken place.

15. If the delay in delivery is such that the Purchaser is entitled to maximum liquidated damages under Clause 14 and if the Product is still not delivered, the Purchaser may In Writing demand delivery within a final reasonable period which shall not be less than one week.

If the Supplier does not deliver within such final period and this is not due to any circumstances which are attributable to the Purchaser, then the Purchaser may by notice In Writing to the Supplier terminate the Contract in respect of such part of the



Product as cannot in consequence of the Supplier's failure to deliver be used as intended by the parties.

If the Purchaser terminates the Contract he shall be entitled to compensation for the loss he suffers as a result of the Supplier's delay, including any consequential and indirect loss. The total compensation, including the liquidated damages which are payable under Clause 14, shall not exceed 15 per cent of that part of the purchase price which is attributable to the part of the Product in respect of which the Contract is terminated.

The Purchaser shall also have the right to terminate the Contract by notice In Writing to the Supplier, if it is clear from the circumstances that there will occur a delay in delivery which, under Clause 14, would entitle the Purchaser to maximum liquidated damages. In case of termination for this reason, the Purchaser shall be entitled to maximum liquidated damages and compensation under the third paragraph of this Clause 15.

16. Liquidated damages under Clause 14 and termination of the Contract with limited compensation under Clause 15 shall be the only remedies available to the Purchaser in case of delay on the part of the Supplier. All other claims against the Supplier based on such delay shall be excluded, except where the Supplier has been guilty of Gross Negligence.
17. If the Purchaser anticipates that he will be unable to accept delivery of the Product at the time for delivery, he shall forth with notify the Supplier In Writing thereof, stating the reason and, if possible, the time when he will be able to accept delivery.

If the Purchaser fails to accept delivery at the time for delivery, he shall nevertheless pay any part of the purchase price which becomes due at the time for delivery, as if delivery had taken place at the time for delivery. The Supplier shall arrange for storage of the Product at the risk and expense of the Purchaser. The Supplier shall also, if the Purchaser so requires, insure the Product at the Purchaser's expense.

18. Unless the Purchaser's failure to accept delivery is due to any such circumstance as mentioned in Clause 41, the Supplier may by notice In Writing require the Purchaser to accept delivery within a final reasonable period.

If, for any reason which is not attributable to the Supplier, the Purchaser fails to accept delivery within such period, the Supplier may by notice In Writing terminate the Contract in whole or in part. The Supplier shall then be entitled to compensation for the loss he suffers by reason of the Purchaser's default, including any consequential and indirect loss. The compensation shall not exceed that part of the purchase price which is attributable to that part of the Product in respect of which the Contract is terminated.

PAYMENT

19. Payment shall be made within 30 days after the date of invoice.

Unless otherwise agreed, the purchase price shall be paid with one third at the formation of the Contract and one third when the Supplier notifies the Purchaser that the Product, or the essential part of it, is ready for delivery. The remaining part of the purchase price shall be paid when the entire Product is delivered.

20. Whatever the means of payment used, payment shall not be deemed to have been effected before the Supplier's account has been irrevocably credited for the amount due.
21. If the Purchaser fails to pay by the stipulated date, the Supplier shall be entitled to interest from the day on which payment was due and to compensation for recovery costs. The rate of interest shall be as agreed between the parties or otherwise 8 percentage points above the rate of the main refinancing facility of the European Central

Bank. The compensation for recovery costs shall be 1 per cent of the amount for which interest for late payment becomes due.

In case of late payment and in case the Purchaser fails to give an agreed security by the stipulated date the Supplier may, after having notified the Purchaser In Writing, suspend his performance of the Contract until he receives payment or, where appropriate, until the Purchaser gives the agreed security.

If the Purchaser has not paid the amount due within three months the Supplier shall be entitled to terminate the Contract by notice In Writing to the Purchaser and, in addition to the interest and compensation for recovery costs according to this Clause, to claim compensation for the loss he incurs. Such compensation shall not exceed the agreed purchase price.

RETENTION OF TITLE

22. The Product shall remain the property of the Supplier until paid for in full to the extent that such retention of title is valid under the relevant law. The Purchaser shall at the request of the Supplier assist him in taking any measures necessary to protect the Supplier's title to the Product. The retention of title shall not affect the passing of risk under Clause 10.

LIABILITY FOR DEFECTS

23. Pursuant to the provisions of Clauses 24-39, the Supplier shall remedy any defect or nonconformity (hereinafter termed defect(s)) resulting from faulty design, materials or workmanship.
24. The Supplier shall not be liable for defects arising out of materials provided or a design stipulated or specified by the Purchaser.
25. The Supplier shall only be liable for defects which appear under the conditions of operation provided for in the Contract and under proper use of the Product.
26. The Supplier shall not be liable for defects caused by circumstances, which arise after the risk has passed to the Purchaser, e.g. defects due to faulty maintenance, incorrect installation or faulty repair by the Purchaser or to alterations carried out without the Supplier's consent In Writing. The Supplier shall neither be liable for normal wear and tear nor for deterioration.
27. The Supplier's liability shall be limited to defects which appear within a period of one year from delivery. If the use of the Product exceeds that which is agreed, this period shall be reduced proportionately.
28. When a defect in a part of the Product has been remedied, the Supplier shall be liable for defects in the repaired or replaced part under the same terms and conditions as those applicable to the original Product for a period of one year. For the remaining parts of the Product the period mentioned in Clause 27 shall be extended only by a period equal to the period during which and to the extent that the Product could not be used as a result of the defect.
29. The Purchaser shall without undue delay notify the Supplier in Writing of any defect which appears. Such notice shall under no circumstances be given later than two weeks after the expiry of the period given in Clause 27 or the extended period(s) under Clause 28, where applicable. The notice shall contain a description of the defect.

If the Purchaser fails to notify the Supplier In Writing of a defect within the time limits set forth in the first paragraph of this Clause, he shall lose his right to have the defect remedied.

Where the defect is such that it may cause damage, the Purchaser shall immediately inform the Supplier In Writing. The Purchaser shall bear the risk of damage to the Product resulting from his failure so

to notify. The Purchaser shall take reasonable measures to minimize damage and shall in that respect comply with instructions of the Supplier.

30. On receipt of the notice under Clause 29 the Supplier shall at his own cost remedy the defect without undue delay, as stipulated in Clauses 23-39. The time for remedial work shall be chosen in order not to interfere unnecessarily with the Purchaser's activities. Repair shall be carried out at the place where the Product is located unless the Supplier deems it more appropriate that the Product is sent to him or a destination specified by him.

If the defect can be remedied by replacement or repair of a defective part and if dismantling and re-installation of the part do not require special knowledge, the Supplier may demand that the defective part is sent to him or a destination specified by him. In such case the Supplier shall have fulfilled his obligations in respect of the defect when he delivers a duly repaired part or a part in replacement to the Purchaser.

31. The Purchaser shall at his own expense provide access to the Product and arrange for any intervention in equipment other than the Product, to the extent that this is necessary to remedy the defect.
32. Unless otherwise agreed, necessary transport of the Product or parts thereof to and from the Supplier in connection with the remedying of defects for which the Supplier is liable shall be at the risk and expense of the Supplier. The Purchaser shall follow the Supplier's instructions regarding such transport.
33. Unless otherwise agreed, the Purchaser shall bear any additional costs which the Supplier incurs for remedying the defect caused by the Product being located in a place other than the destination stated at the formation of the Contract for the Supplier's delivery to the Purchaser or – if no destination has been stated – the place of delivery.
34. Defective parts which have been replaced shall be made available to the Supplier and shall be his property.
35. If the Purchaser has given such notice as mentioned in Clause 29 and no defect is found for which the Supplier is liable, the Supplier shall be entitled to compensation for the costs he incurs as a result of the notice.
36. If the Supplier does not fulfill his obligations under Clause 30, the Purchaser may by notice In Writing fix a final reasonable period for completion of the Supplier's obligations, which shall not be less than one week.
If the Supplier fails to fulfill his obligations within such final period, the Purchaser may himself undertake or employ a third party to undertake necessary repair work at the risk and expense of the Supplier.

Where successful repair work has been undertaken by the Purchaser or a third party, reimbursement by the Supplier of reasonable costs incurred by the Purchaser shall be in full settlement of the Supplier's liabilities for the said defect.

37. Where the Product has not been successfully repaired, as stipulated under Clause 36,
- the Purchaser shall be entitled to a reduction of the purchase price in proportion to the reduced value of the Product, provided that under no circumstances shall such reduction exceed 15 per cent of the purchase price, or
 - where the defect is so substantial as to significantly deprive the Purchaser of the benefit of the Contract as regards the Product or a substantial part of it, the Purchaser may terminate the Contract by notice In Writing to the Supplier in respect of such part of the Product as cannot in consequence of the defect be used as intended by the parties. The Purchaser shall then be

entitled to compensation for his loss, costs and damages up to a maximum of 15 per cent of that part of the purchase price which is attributable to the part of the Product in respect of which the Contract is terminated.

38. Notwithstanding the provisions of Clauses 23-37 the Supplier shall not be liable for defects in any part of the Product for more than one year from the end of the liability period referred to in Clause 27 or from the end of any other liability period agreed upon by the parties.
39. Save as stipulated in Clauses 23-38, the Supplier shall not be liable for defects. This applies to any loss the defect may cause including loss of production, loss of profit and other indirect loss. This limitation of the Supplier's liability shall not apply if he has been guilty of Gross Negligence.

ALLOCATION OF LIABILITY FOR DAMAGE CAUSED BY THE PRODUCT

40. The Supplier shall not be liable for any damage to property caused by the Product after it has been delivered and whilst it is in the possession of the Purchaser. Nor shall the Supplier be liable for any damage to products manufactured by the Purchaser or to products of which the Purchaser's products form a part.
If the Supplier incurs liability towards any third party for such damage to property as described in the preceding paragraph, the Purchaser shall indemnify, defend and hold the Supplier harmless. If a claim for damage as described in this Clause is lodged by a third party against one of the parties, the latter party shall forthwith inform the other party thereof In Writing.
The Supplier and the Purchaser shall be mutually obliged to let themselves be summoned to the court or arbitral tribunal examining claims for damages lodged against one of them on the basis of damage allegedly caused by the Product. The liability between the Supplier and the Purchaser shall however be settled in accordance with Clause 46.
The limitation of the Supplier's liability in the first paragraph of this Clause shall not apply where the Supplier has been guilty of Gross Negligence.

FORCE MAJEURE

41. Either party shall be entitled to suspend performance of his obligations under the Contract to the extent that such performance is impeded or made unreasonably onerous by Force Majeure, meaning any of the following circumstances: industrial disputes and any other circumstance beyond the control of the parties such as fire, war, extensive military mobilization, insurrection, requisition, seizure, embargo, restrictions in the use of power, currency and export restrictions, epidemics, natural disasters, extreme natural events, terrorist acts and defects or delays in deliveries by sub-contractors caused by any such circumstance referred to in this Clause.
A circumstance referred to in this Clause whether occurring prior to or after the formation of the Contract shall give a right to suspension only if its effect on the performance of the Contract could not be foreseen at the time of the formation of the Contract.
42. The party claiming to be affected by Force Majeure shall notify the other party In Writing without delay on the intervention and on the cessation of such circumstance. If a party fails to give such notice, the other party shall be entitled to compensation for any additional costs which he incurs and which he could have avoided had he received such notice.
If Force Majeure prevents the Purchaser from fulfilling his obligations, he shall compensate the Supplier for expenses incurred in securing and protecting the Product.
43. Regardless of what might otherwise follow from these General Conditions, either party shall be entitled to terminate the Contract



by notice In Writing to the other party if performance of the Contract is suspended under Clause 41 for more than six months.

ANTICIPATED NON-PERFORMANCE

44. Notwithstanding other provisions in these General Conditions regarding suspension, each party shall be entitled to suspend the performance of his obligations under the Contract, where it is clear from the circumstances that the other party is not going to perform his obligations. A party suspending his performance of the Contract shall forthwith notify the other party thereof In Writing.

CONSEQUENTIAL LOSSES

45. Save as otherwise stated in these General Conditions there shall be no liability for either party towards the other party for loss of production, loss of profit, loss of use, loss of contracts or for any other consequential or indirect loss whatsoever.

DISPUTES AND APPLICABLE LAW

46. All disputes arising out of or in connection with the Contract shall be finally settled under the Rules of Arbitration of the International Chamber of Commerce by one or more arbitrators appointed in accordance with the said Rules.

47. The Contract shall be governed by the substantive law of the Supplier's country.

This is an Orgalime publication. Orgalime represents the mechanical, electrical, electronic and metalworking industries in Europe.

All rights reserved ©

Editeur responsable :
Adrian Harris, Director General
ORGALIME – The European Engineering Industries Association
Diamant Building, Boulevard A Reyers 80, B-1030 Brussels
Tel: +32 2 706 82 35
Fax: +32 2 706 82 50
secretariat@orgalime.org
www.orgalime.org

Pour la FOURNITURE DE PRODUITS MÉCANIQUES, ÉLECTRIQUES ET ÉLECTRONIQUES - Bruxelles, Mars 2012

PRÉAMBULE

1. Les présentes Conditions Générales sont applicables sous réserve de l'accord des parties, qu'il soit donné Par Écrit ou autrement. Toute modification ou dérogation de celles-ci doit être acceptée Par Écrit.

DÉFINITIONS

2. Dans les présentes Conditions Générales, les termes ci-dessous sont définis comme suit :
 - « Contrat » : l'accord Par Écrit entre les parties concernant la fourniture des Produits et tous ses accessoires, y compris les modifications et ajouts dans les documents concernés;
 - « Faute Lourde » : tout acte ou omission impliquant soit un défaut d'attention caractérisé à des conséquences graves pouvant en résulter et qu'un contractant diligent aurait normalement prévues, ou tout défaut délibéré de prise en compte des conséquences d'un tel acte ou d'une telle omission;
 - « Par Écrit » : communication par document signé par chacune des parties ou par courrier, télécopie, courriel ou par tout autre moyen convenu par les parties;
 - « le Produit » : l'(les) objet(s) à être fourni(s) au titre du contrat, logiciels et documentation inclus.

INFORMATION SUR LE PRODUIT

3. Les renseignements et informations concernant le Produit contenus dans les catalogues et tarifs, ne sont contractuels que dans la mesure où ils sont inclus Par Écrit dans le Contrat par une référence expresse.

PLANS ET INFORMATIONS TECHNIQUES

4. Tous les plans et documents techniques relatifs au Produit ou à sa fabrication, qui ont été soumis par une partie à l'autre partie avant ou après la conclusion du Contrat, demeurent la propriété de la partie qui les a remis. Les plans, documents techniques et toute autre information technique reçus par une partie ne seront pas utilisés, sans l'accord de l'autre partie, à d'autres fins que celles pour lesquelles ils ont été prévus. Sans le consentement de la partie qui les soumet, ils ne peuvent être utilisés à d'autres fins ou copiés, reproduits, transmis ou communiqués à un tiers.
5. Le Fournisseur doit fournir gratuitement à l'Acheteur, pas plus tard qu'à la date de livraison, l'information et les documents nécessaires pour permettre à ce dernier d'installer, de faire la réception, d'exploiter et d'entretenir le Produit. Cette information et ces documents sont fournis en un nombre d'exemplaires qui est défini d'un commun accord ou en au moins deux exemplaires. Le Fournisseur n'est pas tenu de fournir les schémas de fabrication du Produit ou des pièces détachées.

ESSAIS DE RÉCEPTION

6. Sauf stipulations différentes, les essais de réception prévus au Contrat, doivent se dérouler sur le lieu de fabrication, aux heures normales de travail. Si le Contrat ne stipule aucune exigence technique, les essais de réception se dérouleront conformément à la pratique générale en vigueur dans la branche d'industrie concernée du pays de fabrication.
7. Suffisamment en avance pour lui permettre d'être représenté, le Fournisseur notifie les essais de réception à l'Acheteur Par Écrit. Si l'Acheteur n'est pas représenté, les rapports d'essais seront adressés à l'Acheteur et seront acceptés comme probants.
8. Si les rapports d'essais prouvent que le Produit n'est pas conforme au Contrat, le Fournisseur doit, sans délai, remédier aux défauts

afin de mettre le Produit en conformité avec le Contrat. De nouveaux essais seront alors effectués à la demande de l'Acheteur sauf si le défaut n'est pas significatif.

9. Le Fournisseur supporte les coûts des essais de réception effectués sur le lieu de fabrication. L'Acheteur supporte toutefois les frais de déplacement de ses représentants durant les essais.

LIVRAISON – TRANSFERT DES RISQUES

10. Les conditions de livraison convenues sont interprétées conformément aux INCOTERMS® en vigueur à la date de conclusion du Contrat. Si aucune condition de livraison particulière n'a été convenue, la livraison a lieu Franco transporteur ou « Free Carrier » (FCA) au lieu désigné par le Fournisseur. Si, dans le cas de livraison Franco transporteur, et à la demande de l'Acheteur, le Fournisseur s'engage à expédier le Produit à sa destination, le transfert des risques a lieu au plus tard lors de la remise du Produit au premier transporteur. Des expéditions partielles ne sont pas admises, sauf stipulations contraires.

DATE DE LIVRAISON - RETARD

11. Si, au lieu de stipuler une date de livraison, les parties ont stipulé un délai à l'expiration duquel la livraison doit avoir lieu, ce délai court à compter du jour où le Contrat est entré en vigueur, et où toutes les conditions préalables à la charge de l'Acheteur ont été respectées, telles que des formalités officielles, les paiements dus à la conclusion du Contrat et les garanties.
12. Si le Fournisseur prévoit qu'il ne pourra livrer le Produit dans le délai convenu, il doit le notifier immédiatement, Par Écrit à l'Acheteur, en indiquant le motif et si possible la date prévisible de livraison. En cas de manquement du Fournisseur à l'obligation de notification, l'Acheteur est en droit de recevoir une compensation pour les coûts additionnels qu'il a subis et qu'il aurait pu éviter s'il avait reçu la notification.
13. Si le retard de livraison est causé par un événement mentionné à la Clause 41 ou en raison d'un acte ou d'une omission imputable à l'Acheteur, y compris la suspension du Contrat en application des Clauses 21 et 44, ou toute autre circonstance imputable à l'Acheteur, le Fournisseur sera en droit de repousser la date de livraison d'un délai nécessaire compte tenu de toutes les circonstances. Cette disposition s'applique, que la cause du retard se soit manifestée avant ou après la date à laquelle la livraison aurait dû avoir lieu.
14. Si le Produit n'est pas livré à la date prévue, l'Acheteur a droit à des dommages-intérêts pour retard à compter de la date de livraison contractuelle. Les dommages-intérêts pour retard sont payables à un taux de 0,5 % du prix d'achat pour chaque semaine commencée de retard. Les dommages-intérêts pour retard ne pourront excéder 7,5 % du prix d'achat. Si c'est une partie du Produit dont la livraison est retardée, les dommages-intérêts pour retard sont calculés sur la partie du prix d'achat du Produit relative à l'élément qui, en raison du retard, ne peut être utilisé comme convenu. Les dommages-intérêts pour retard sont dus à compter de la demande Par Écrit formulée par l'Acheteur mais pas avant que la livraison ne soit achevée ou le Contrat résilié en application de la Clause 15.

L'Acheteur perd son droit à des dommages-intérêts pour retard s'il n'en fait pas la demande écrite dans les six mois qui suivent la date à laquelle la livraison aurait dû avoir lieu.
15. Si le retard de livraison est tel que l'Acheteur a droit au maximum des dommages-intérêts en vertu de la Clause 14 et si le Produit n'est toujours pas livré, l'Acheteur peut Par Écrit exiger une livraison dans un délai raisonnable ultime qui ne sera pas inférieur à une semaine. Si le Fournisseur n'effectue pas la livraison dans cet ultime délai et sauf dans des circonstances imputables à l'Acheteur,

celui-ci peut, par notification adressée Par Écrit au Fournisseur, résilier le Contrat pour la partie du Produit qui, en raison de la défaillance du Fournisseur, ne peut être utilisée comme convenu. En cas de résiliation du Contrat par l'Acheteur, ce dernier a droit à être indemnisé pour les dommages qu'il subit du fait du retard du Fournisseur, y compris tout dommage direct et indirect. Le montant total de cette indemnisation y compris les dommages-intérêts pour retard prévus à la Clause 14, n'excédera pas 15 % du prix d'achat correspondant à la partie du Produit, objet de la résiliation. L'Acheteur a également le droit de résilier le Contrat par notification Par Écrit au Fournisseur, s'il résulte de façon patente de toutes les circonstances, qu'un retard se produira dans la livraison lui permettant, conformément à la Clause 14, d'obtenir le maximum des dommages-intérêts. En cas de résiliation pour ce motif, l'Acheteur a droit au maximum des dommages-intérêts pour retard et à l'indemnisation stipulée au 3ème paragraphe de la présente Clause 15.

16. Les dommages-intérêts prévus par la Clause 14 et l'indemnisation accompagnant la résiliation prévue par la Clause 15, sont les seuls recours dont dispose l'Acheteur, en cas de retard du Fournisseur. Toute autre réclamation fondée sur ce retard est exclue, sauf Faute Lourde imputable au Fournisseur
17. Si l'Acheteur prévoit qu'il ne pourra accepter la livraison du Produit à la date de livraison, il doit en avertir immédiatement le Fournisseur Par Écrit en lui indiquant le motif et si possible la date à laquelle il sera en mesure d'accepter la livraison. Si l'Acheteur reste en défaut d'accepter la livraison, à la date de livraison, il doit toutefois payer la partie du prix qui est payable comme si la livraison avait eu lieu. Le Fournisseur prendra toute disposition aux frais et risques de l'Acheteur pour stocker le Produit. À la demande de l'Acheteur, le Fournisseur fera également assurer le Produit aux frais de l'Acheteur.
18. Sauf si l'Acheteur est empêché de procéder à la réception de la livraison pour un motif relevant de la Clause 41, le Fournisseur peut, Par Écrit, mettre en demeure l'Acheteur d'avoir à réceptionner la livraison dans un ultime délai raisonnable. Si, pour un motif qui n'est pas imputable au Fournisseur, l'Acheteur ne réceptionne pas la livraison dans ce délai, le Fournisseur peut, Par Écrit, résilier le Contrat en totalité ou en partie. Le Fournisseur est en droit d'être indemnisé pour les pertes qu'il a subies du fait de la défaillance de l'Acheteur, y compris pour les dommages directs et indirects. Cette indemnisation ne doit pas excéder le prix d'achat de la partie du Produit soumise à la résiliation.

PAIEMENT

19. Les paiements sont effectués dans les 30 jours de la date de la facture. Sauf stipulations différentes, un tiers du prix est payable à la conclusion du Contrat et un tiers à la notification par le Fournisseur à l'Acheteur que le Produit ou une partie essentielle de celui-ci est mis à sa disposition pour livraison. Le paiement du solde du prix a lieu lorsque le Produit a fait l'objet d'une livraison complète.
20. Quel que soit le moyen de paiement utilisé, tout paiement n'est pas considéré comme effectué tant que le compte du Fournisseur n'est pas irrévocablement crédité de la somme due.
21. Si à la date stipulée l'Acheteur n'a pas payé, le Fournisseur a droit à des intérêts moratoires, à compter du jour où le paiement devait être effectué, ainsi qu'à une indemnité pour frais de recouvrement. Le taux de ceux-ci est celui qui aura été convenu entre les parties et à défaut, celui du refinancement de la Banque centrale européenne majoré de 8 points. L'indemnité pour frais de recouvrement sera de 1 pour cent de la somme pour laquelle l'intérêt de retard est dû. En cas de paiement retardé, et dans le cas où l'Acheteur ne remet pas la garantie de paiement convenue à la date stipulée, le Fournisseur peut, après en avoir averti l'Acheteur Par Écrit, suspendre l'exécution du Contrat jusqu'à réception du paiement ou, le cas

échéant, jusqu'à la remise par l'Acheteur de la garantie convenue. Si dans les trois mois l'Acheteur n'a pas payé le montant dû, le Fournisseur est en droit, par notification Par Écrit adressée à l'Acheteur, de résilier le Contrat et de demander, outre les intérêts et l'indemnité pour frais de recouvrement prévus à la présente Clause, à être indemnisé des pertes qu'il subit. Cette indemnisation ne doit pas excéder le prix d'achat convenu.

RÉSERVE DE PROPRIÉTÉ

22. Le Produit demeure la propriété du Fournisseur jusqu'à complet paiement de son prix, dans la mesure où cette réserve de propriété est valable au regard du droit concerné. À la demande du Fournisseur, l'Acheteur assiste le Fournisseur dans la prise des mesures nécessaires pour protéger la propriété du Fournisseur sur le Produit. La réserve de propriété ne modifie pas le transfert des risques tel que prévu à la Clause 10.

RESPONSABILITÉ POUR DÉFAUTS

23. Le Fournisseur s'engage à réparer tout défaut ou non conformité (ci-après qualifié de "défaut(s)") résultant d'un défaut de conception, de matière ou de fabrication dans les conditions définies aux Clauses 24 à 39.
24. Le Fournisseur n'est pas responsable des défauts résultant des matières fournies ou d'une conception stipulée ou spécifiée par l'Acheteur.
25. Le Fournisseur ne sera responsable des défauts que dans la mesure des conditions d'utilisation contractuelles et d'une utilisation normale du Produit.
26. Le Fournisseur ne sera pas responsable des défauts causés par des circonstances apparaissant après le transfert des risques à l'Acheteur, tels que des défauts dus à une maintenance fautive, une installation incorrecte ou une réparation fautive par l'Acheteur, ou des altérations apportées sans l'accord Par Écrit du Fournisseur. Le Fournisseur ne sera pas non plus responsable des détériorations résultant de l'usage normal.
27. La responsabilité du Fournisseur est limitée aux défauts qui apparaissent dans le délai d'un an suivant la livraison. Cette période sera proportionnellement réduite si l'usage quotidien du Produit excède celui qui est convenu.
28. Après que le défaut d'une partie du Produit ait été réparé, le Fournisseur garantit la pièce réparée ou remplacée pendant un an dans les mêmes conditions que s'il s'agissait du Produit lui-même. Pour les autres parties du Produit, la période mentionnée à la Clause 27 est étendue de la durée pendant laquelle, et dans la mesure où, le Produit n'a pas pu être utilisé en raison du défaut. L'Acheteur doit notifier Par Écrit le défaut sans délai au Fournisseur dès qu'il apparaît. En aucun cas, cette notification ne doit être émise plus de deux semaines après l'expiration de la période mentionnée à la Clause 27 ou de la période étendue définie à la Clause 28 lorsqu'elle est applicable. La notification doit comprendre une description du défaut. Si l'Acheteur ne notifie pas Par Écrit le défaut au Fournisseur, dans le délai mentionné au premier paragraphe de la présente Clause, il perd son droit à la réparation du défaut. Dans le cas où le défaut est tel qu'il risque de provoquer un dommage, l'Acheteur doit en informer immédiatement le Fournisseur Par Écrit. L'Acheteur supporte le risque de dommages au Produit résultant d'une absence de notification. L'Acheteur doit prendre les mesures raisonnables afin de minimiser le dommage et devra à cet égard agir conformément aux instructions du Fournisseur.
30. Dès réception de la notification conformément à la Clause 29, le Fournisseur, à ses frais, remédie aussi vite que possible au défaut, dans les conditions des Clauses 23 à 39. Le moment de cette intervention corrective sera choisi dans le but de ne pas

interférer inutilement sur l'activité de l'Acheteur. Les réparations sont effectuées à l'endroit où se trouve le Produit, à moins que le Fournisseur ne juge plus approprié que le Produit lui soit envoyé ou soit envoyé à une destination qu'il aura spécifiée. Dans le cas où il peut être remédié au défaut d'une pièce défectueuse par son remplacement ou sa réparation et si son démontage et son remontage ne nécessite pas une compétence particulière, le Fournisseur pourra demander que la pièce défectueuse lui soit expédiée, ou soit expédiée à une destination spécifiée par lui. Dans un tel cas, le Fournisseur aura rempli son obligation par rapport au défaut, en livrant à l'Acheteur une pièce réparée ou de remplacement.

31. Dans la mesure où cela est nécessaire à la réparation du défaut, l'Acheteur permettra l'accès au Produit et fera son affaire de toute intervention sur des équipements autres que le Produit.
32. Sauf stipulations différentes, le Fournisseur supporte les risques et les frais consécutifs au transport aller et retour du Produit et/ou des pièces, liés à la réparation des défauts dont le Fournisseur est responsable. Pour ce transport, l'Acheteur doit suivre les instructions données par le Fournisseur.
33. Sauf stipulations différentes, l'Acheteur supporte les coûts additionnels encourus pour remédier au défaut causé par le Produit dans un lieu autre que la destination convenue lors de la formation du Contrat ou que le lieu de livraison, en l'absence d'une telle mention.
34. Les pièces défectueuses remplacées sont mises à la disposition du Fournisseur et sont sa propriété.
35. Si l'Acheteur a procédé à la notification mentionnée à la Clause 29 et qu'aucun défaut dont le Fournisseur est responsable n'a été identifié, le Fournisseur aura droit à une indemnisation pour les coûts qu'il aura supportés en conséquence de cette notification.
36. Si le Fournisseur n'a pas rempli ses obligations découlant de la Clause 30, l'Acheteur peut, par notification Par Écrit, fixer un délai final raisonnable pour l'accomplissement par le Fournisseur de ses obligations, qui ne peut être inférieur à une semaine. Si le Fournisseur ne remplit pas ses obligations dans ce délai final, l'Acheteur peut procéder ou faire procéder par un tiers aux opérations de réparation nécessaires, aux frais et risques du Fournisseur.

Si ces opérations de réparation ont été menées avec succès par l'Acheteur ou par un tiers, le remboursement par le Fournisseur des coûts raisonnables supportés par l'Acheteur, vaudra pleine et entière décharge des obligations encourues par le Fournisseur du fait du dit défaut.

37. Si la réparation du Produit n'a pas été effectuée avec succès, comme il est stipulé à la Clause 36 :
 - a. L'Acheteur a droit à une réduction du prix d'achat proportionnellement à la diminution de valeur du Produit, pourvu qu'en aucune circonstance une telle réduction n'excède 15 % du prix d'achat, ou
 - b. si le défaut est d'une importance telle qu'elle prive l'Acheteur, de façon significative, du bénéfice du Contrat en ce qui concerne le Produit ou une partie substantielle de celui-ci, l'Acheteur peut résilier le Contrat par notification Par Écrit adressée au Fournisseur dans la mesure de la partie du Produit qui ne peut, du fait du défaut, être utilisé comme les parties en avaient convenu. L'Acheteur est alors en droit d'obtenir une compensation pour ses pertes, coûts et dommages dans la limite maximum de 15 % de la partie du prix d'achat correspondant à la partie du Produit au titre duquel le contrat est résilié.
38. Nonobstant les dispositions des Clauses 23 à 37, le Fournisseur est déchargé de toute responsabilité pour tout défaut du Produit,

au bout d'un an à compter de la fin de la durée de responsabilité mentionnée dans la Clause 27 ou à compter de la fin de toute autre durée de responsabilité convenue entre les parties.

39. La responsabilité du Fournisseur pour les défauts est limitée aux stipulations des Clauses 23 à 38. Cette limitation exclut la réparation de tout autre dommage résultant du défaut, y compris pertes de production, pertes de bénéfice et tout autre dommage indirect. Cette limitation ne s'applique pas en cas de Faute Lourde.

PARTAGE DES RESPONSABILITÉS EN CAS DE DOMMAGE DU FAIT DU PRODUIT

40. Le Fournisseur n'est responsable d'aucun dommage aux biens du fait du Produit après sa livraison dès que l'Acheteur en a pris possession. De la même façon, le Fournisseur n'est pas responsable ni des dommages causés aux produits fabriqués par l'Acheteur, ni aux produits incorporant ceux de l'Acheteur. Si le Fournisseur encourt une responsabilité à l'égard d'un tiers pour des dommages aux biens tels que décrits ci-dessus, l'Acheteur est tenu d'indemniser, de défendre et de garantir le Fournisseur. Si une action en dommages-intérêts, sur les fondements décrits dans la présente Clause, est introduite par un tiers contre l'une des parties, celle-ci en informera immédiatement l'autre partie Par Écrit. Le Fournisseur et l'Acheteur doivent se laisser attraire devant le tribunal ou l'instance arbitrale jugeant l'action en dommages-intérêts introduite sur le fondement d'un dommage prétendument causé par le Produit. Toutefois, les questions relatives à la responsabilité entre le Fournisseur et l'Acheteur seront réglées conformément à la Clause 46. La limitation de responsabilité du Fournisseur résultant du 1er paragraphe de cette Clause ne s'applique pas en cas de Faute Lourde du Fournisseur.
42. La partie qui demande l'application de la Force Majeure doit notifier sans délai, Par Écrit, à l'autre partie le début et la fin de la circonstance ainsi qualifiée. Si une partie manque à son obligation de faire une telle notification, l'autre partie aura droit à une indemnisation pour tous les coûts supplémentaires qui en résultent et qu'elle aurait pu éviter si elle avait reçu cette notification. Si la Force Majeure empêche l'Acheteur de remplir ses obligations, il devra indemniser le Fournisseur des coûts résultant de la protection et de la mise en sécurité du Produit.
43. Quelle que soit la conséquence qui en résulterait dans les présentes Conditions Générales, chaque partie est en droit de résilier le Contrat, par une notification Par Écrit adressée à l'autre partie, si l'exécution du Contrat est suspendue du fait de la Clause 41 pendant plus de six mois.

INEXÉCUTION ANTICIPÉE

44. Nonobstant les autres stipulations de ces Conditions Générales concernant la suspension, chaque partie a le droit de suspendre l'exécution de ses obligations résultant du Contrat lorsqu'il résulte clairement des circonstances que l'autre partie ne va pas exécuter ses obligations. Une partie suspendant l'exécution de ses obligations résultant du Contrat doit aussitôt le notifier Par Écrit à l'autre partie.

DOMMAGES INDIRECTS

45. Sauf stipulations différentes des présentes Conditions Générales, aucune partie ne sera responsable à l'égard de l'autre, des pertes de production, pertes de profit, pertes d'usage, pertes de contrats ou de tout autre dommage ou pertes indirectes quels qu'ils soient.

LITIGES ET LOI APPLICABLE

46. Tous différends découlant du Contrat ou en relation avec celui-ci, seront tranchés définitivement suivant le Règlement d'Arbitrage de la Chambre de Commerce Internationale par un ou plusieurs arbitres nommés conformément à ce Règlement.



47. Le Contrat est soumis à la loi de fond du pays du Fournisseur.

Ceci est une publication Orgalime. Orgalime regroupe les associations européennes des secteurs mécanique, électrique, électronique et de la transformation des métaux.

ous droits réservés ©

Editeur responsable :
Adrian Harris, Directeur général
ORGALIME – The European Engineering Industries Association
Diamant Building, Boulevard A Reyers 80, B-1030 Brussels
Tel: +32 2 706 82 35
Fax: +32 2 706 82 50
secretariat@orgalime.org
www.orgalime.org

Stef van Bakel

koeltechniek

Alkmaar ☎ 072 564 7000

www.combisteel.com